

# ZeroStep Guidelines



## ZeroStep® Guidelines©

Margaret Biggs, Interior Designer, CAPS

Joanne Feutz, Registered Occupational Therapist, CAPS

Renee Thompson, Certified Occupational Therapy Assistant, CAPS

May 19, 2008

The ZeroStep Guidelines have been prepared as guidance for builders, designers and developers engaged in or interested in universal design practices and products for residential design, development and construction. This publication is not intended to be exhaustive and all-inclusive and the enclosed guidelines are not to be considered the only method of universal design. Anyone designing, developing or constructing a new home or remodeling an existing home has an independent obligation to ascertain that their plans, actions, and practices represent sound business practices for their design and installation and meet all relevant laws, codes, and standards.

Designers, developers and builders should vary their approach with respect to particular installations, products, or locations based on specific factual circumstances, the practicality and effectiveness of the particular design or installation, or its technical feasibility. These guidelines are not designed or intended to define or create legal rights or obligations. Any recommendation, express or implied, is for illustrative purposes, and is not intended to be an endorsement of any particular product or manufacturer.

ZeroStep or Disability Advocates of Kent County does not make any warranty or representation, either express or implied, with respect to the accuracy or completeness of the information contained in the planning guidelines, nor does ZeroStep or Disability Advocates of Kent County assume any liability of any kind whatsoever resulting from the use of or reliance upon any information, conclusions, or opinions contained herein.

Copyright 2009 by ZeroStep and Disability Advocates of Kent County, All Rights Reserved. No part of this publication may be reproduced, stored in a retrieval system, or transmitted in any form by any means, electronic, mechanical, photocopying, recording, or otherwise without the prior written consent of ZeroStep or Disability Advocates of Kent County.





## Contents

List of Figures	vi
Acknowledgements	vii
Introduction	ix
What is ZeroStep?	ix
What is Universal Design?	ix
How do you benefit from ZeroStep and Universal Design?	x
What are ZeroStep Guidelines?	xi
How to use the ZeroStep Guidelines?	xi
Point System	xii
ZeroStep Home Certification process	xiii
<b>ZeroStep Guidelines</b>	
<b>Chapter 1. Exterior Accessible Routes and Spaces</b>	<b>1-9</b>
101 Components of an Accessible Route and Accessible Home Design	1
102 Parking and Driveways	1
103 Garage	2
104 Walks and Pathways	3
105 Porches, Patios, Decks and Landings	5
106 Ramps	6
<b>Chapter 2. Interior Accessible Routes and Spaces</b>	<b>10-14</b>
201 Doors and Doorways	10
202 Hallways	12
203 Stairways	12
204 Elevators	14
205 Balconies, Lofts, Raised or Sunken Areas and Split-Level Entries	14
<b>Chapter 3. Bathrooms</b>	<b>15</b>
<b>Chapter 4. Bedrooms</b>	<b>22</b>

Chapter 5. Closets	23
Chapter 6. Kitchens	24
Chapter 7. Laundry Room	28
Chapter 8. Living Room	30
Chapter 9. Flooring	31
Chapter 10. Windows	32
Chapter 11. Lighting	33
Chapter 12. Lighting Controls, Electrical Switches, and Outlets	34
Chapter 13. Heating, Ventilation and Cooling	36
Chapter 14. Technology and Automation In The Home	37
ZeroStep Checklist	39-62
References	63
Appendixes	65-245
Appendix A: Notes	64
Appendix B: Code Comparisons	91
Appendix C: Glossary	231



## List of Figures

### Chapter 1. Exterior Accessible Routes and Spaces

Fig. 103.1 Minimum Measurements – One Stall Garage

Fig. 103.2 Minimum Measurements – Two Stall Garage

Fig. 104.3 Changes in Level

Fig. 105.1 Porch

Fig. 106.4 Ramp Clear Width

Fig. 106.6.4 Ramp Landing Change In Direction – 90° Turn

Fig. 106.6.5 Ramp Landing Change In Direction – 180° Turn

Fig. 106.8 Ramp Handrails

Fig. 106.9 Ramp Handrail Clearance and Graspability

### Chapter 2. Interior Accessible Routes and Spaces

Fig. 201.2 Door Clear Width

Fig. 201.3 18" Minimum Maneuvering Clearance

Fig. 201.4 Swinging Doorways, Sliding and Folding Doorways,  
Doorways Without Doors and Pocket Doors

Fig. 201.5 Split Level Landing

Fig. 201.6 Two Doors In Series

Fig. 203 Stairways

### Chapter 3. Bathrooms

Fig. 301.2 Bathroom Turning Space and Clear Floor Space

Fig. 301.3 Bathroom Clear Floor Space

Fig. 301.4 Bathroom Toilet Clear Floor Space

Fig. 301.6 Bathroom Wall Reinforcement & Grab Bar Locations

### Chapter 6. Kitchens

Fig. 601 Opt. 26 Switches and Outlets Over Counters On Back Wall

Fig. 601 Opt. 27 Switches and Outlets Over Counters On Side Wall

### Chapter 7. Laundry Room

Fig. 701.2 Laundry Room Clear Floor Space and Turning Space



## Acknowledgments

ZeroStep would like to thank the following individuals and organizations for contributing to this project.

### **2007 Edition:**

#### **Financial Supporters:**

Dyer Ives Foundation  
Grand Rapids Community Foundation  
John and Nancy Kennedy Foundation  
Mary Free Bed Guild  
Slemons Foundation  
Steelcase Foundation  
Wheeler Family Foundation  
Kate and Richard Wolters Family Foundation

#### **ZeroStep Advisory Committee:**

Ricardo D. Anselmo, AIA – Anselmo & Associates, Lansing, MI  
Margaret A. Biggs, Interior Designer, CAPS – ZeroStep Program, Disability Advocates of Kent Co., Grand Rapids, MI  
David Bulkowski, JD & Executive Director – Disability Advocates of Kent Co., Grand Rapids, MI  
Fred Cheslek – Cheslek Construction LLC, Rockford, MI  
Pat DeBoer – Owner & Broker of DeBoer Realty, Belmont, MI  
Jocelyn Dettloff – Development Director for Disability Advocates of Kent Co., Grand Rapids, MI  
Joanne Feutz, OTR, CAPS – ZeroStep Program, Disability Advocates of Kent Co., Grand Rapids, MI  
Rich Kogelschatz CGB, CAPS – Heartland Builders LLC, Rockford, MI  
Kline Kauramaki – J.W. Messner, Inc., Grand Rapids, MI  
Mike Murphy – J.W. Messner, Inc., Grand Rapids, MI  
James Stortz – Director of Design at Eastbrook Builders, Grand Rapids, MI  
Renee Thompson, COTA, CAPS – ZeroStep Program, Disability Advocates of Kent Co., Grand Rapids, MI  
Jeff VandenBosch, AIA – Beta Design, Grand Rapids, MI  
Pat Wyckoff, Interior Designer – Rockford, MI

#### **Additional Contributors:**

Covenant Developments, Grand Rapids, MI  
Cox, Medendorp & Olson Architects, Grand Rapids, MI  
Brian S. Gill, AIA – TDG Architects, Pontiac, MI  
J.W. Messner Inc., Integrated Marketing Communications, Grand Rapids, MI

Michigan Association of Home Builders, Lansing, MI  
David Peters – Peters Group Architects & DP Development Co., Ann Arbor, MI  
Irvin Poke, AIA – State of Michigan Bureau of Construction Codes & Fire Safety,  
Lansing, MI  
Don Pratt – Wake Pratt Construction Company, Auburn Hills, MI  
Lee Schwartz – Michigan Association of Home Builders, Lansing, MI

**2016 Edition:**

**Financial Supporters:**

**ZeroStep Advisory Committee:**

**Additional Contributors:**



# ZeroStep Introduction



## Introduction

This document contains guidelines to achieve a zero-step universally designed home. In addition, a homeowner or builder must use these guidelines to accomplish a ZeroStep Certified Home. These guidelines are to be applied during the design, construction and alteration of homes.

These guidelines are voluntary, not mandatory criteria applied to housing design which meet or exceed Michigan residential codes.

## What is ZeroStep?

ZeroStep provides comprehensive universal design consulting services for people in Michigan.

Our professional staff is comprised of Certified Aging in Place Specialists through the National Association of Home Builders. They also possess extensive experience in Interior Design and Occupational Therapy.

We work with individual consumers or families as well as with architects, interior designers, builders, building organizations, developers, contractors, remodelers, and realtors to achieve a home with maximum flexibility and value that enhances all stages of life.

## What is universal design?

“Universal design is the design of products and environments to be usable by all people, to the greatest extent possible, without the need for adaptation or specialized design.” —  
*Ron Mace (The Center for Universal Design at North Carolina State University.)*

As the name implies, universal design elements have universal appeal and application. This does not mean that universal design is about one size fits all. Instead, it is the only design concept that designs to accommodate peoples’ differences, not their similarities.

Universal design differs from “accessible,” “adaptable,” and “visitable” design.

- *Accessible design* complies with regulations or criteria that establish a minimum level of design necessary to accommodate people with disabilities. It applies primarily to commercial buildings or multiple housing units.
- *Adaptable design* allows some features of a building or home to be easily changed to meet the needs of an individual with a disability or a person encountering limitations as he or she ages. For example, cabinets under sinks can be designed to be removable whereby the storage space under the sinks are replaced for knee space for a wheelchair user.
- *Visitable design* predominately focuses on the inclusion of one accessible entrance and a ground floor bathroom, not the whole home. A visitable home allows guests with disabilities to visit and can help a resident adapt in his/her home should the resident's needs change due to a disability or reduced mobility.

## How do you benefit from ZeroStep and universal design?

National and state codes provide only minimum requirements to accommodate people with disabilities and do not apply to all people, nor extend into single family residential construction. For example, Michigan Building Codes are for commercial construction, while Michigan Residential Codes have little to no accessibility minimums.

ZeroStep saw the national standards as a good starting point, but not a good ending point. Hence, ZeroStep developed comprehensive Guidelines in order to help people understand how to incorporate universal design elements into their homes and achieve the most flexible and usable home possible.

We want to change the housing paradigm so that the home environment is usable and safe for as many people as possible. Homes should be easy to live in!

- A ZeroStep universally designed home makes day to day activities possible for some and easier for many. For example, a zero-step entrance is great for moving furniture in and out and is essential for a person with a mobility aid to effortlessly visit a friend.
- A ZeroStep universally designed home is family friendly by taking into account the safety and accessibility needs of small children and older visitors.
- A ZeroStep universally designed home addresses the buyer's future needs which are often unrecognized. People can live in their ZeroStep homes for as long as they choose, rather than being forced to move due to some unforeseen event ... whether a temporary disability ... or a life-changing event. Being able to remain in one's home through life-stage changes is more psychologically supportive and cost-effective than being forced to move.

- Because zero-step universal design features can be easily adapted later, costly renovations may often be avoided, fostering a sense of security and helping to maintain a sense of place and community.

Ultimately, ZeroStep changes residential construction by building responsibly, so that we meet the needs of the present and the future.

## What are ZeroStep Guidelines?

The ZeroStep Guidelines are voluntary standards for building a home. They meet or exceed ICC/ANSI A117.1 – 2003, Fair Housing Guidelines, Michigan Building Code 2006 (based on International Construction Code 2006) and Michigan Residential Code 2006.

- They are a reference resource tool for architects, interior designers, and builders, building organizations, developers, contractors, remodelers, realtors and homeowners.
- They guarantee a base line for designing a ZeroStep Certified Home.
- ZeroStep Guidelines lead users through the decision making process.

## How to use the ZeroStep Guidelines

ZeroStep Guidelines are comprised of prerequisites and optional credits. Prerequisites are the foundation of a ZeroStep Certified Home or House Plan. They deal with issues that are difficult and costly to change after initial construction or are of paramount importance in terms of safety and sufficient space. Prerequisites are required if the home or house plan is to be ZeroStep Certified.

Optional credits, however, are elective. They offer a greater degree of universal design features that further enhance the qualities of the home. Optional credits are also assigned points. The points determine whether the home is bronze, silver, or gold. For a future home buyer, the designation communicates that (1) this is a ZeroStep Certified Home, (2) it has additional universal design features, and (3) it is an appealing environment that adds value and is marketable to a broad base of home buyers.

Become thoroughly familiar with the ZeroStep Guidelines prior to designing a home so that the prerequisites are incorporated into the home's design and construction. The guidelines begin with the exterior and work towards the interior of the home, so they parallel the design process.

The ZeroStep Checklist comes immediately after the guidelines. Keep it at your side when designing or reviewing floor plans. The checklist is also extremely helpful when gathering client needs during the design phase.

The Appendixes are vital components of the ZeroStep Guidelines that should not be overlooked. Appendix A: Notes contains the logic and additional information behind the guidelines. Appendix B: Codes Comparison relates the ZeroStep Guidelines to other national or State of Michigan codes and standards. Appendix C: Glossary defines terms used throughout the guidelines.

Check ZeroStep's website at [www.zerostep.org](http://www.zerostep.org) to learn more about ZeroStep certification, obtain training continuing education credits (CEUs), general public education forums, and universally designed products.

## Point System

A point system has been established to communicate the level of universal design features that have been incorporated into the home. Points can be accumulated by executing the options that follow the prerequisites in each section of the guidelines.

**Point Scale:**

50 – 179 points = Bronze

180 – 309 points = Silver

310 – 448 points = Gold

The options range in value from 1 to 3 points, with 3 points considered exceptionally beneficial in terms of the home's added function, comfort and safety. Based on the total number of points accrued, a ZeroStep Home can fall into three classifications: bronze, silver or gold.

# ZeroStep Home Certification Process

## What ZeroStep Certifies

ZeroStep certifies individual homes and floor plans according to their compliance with the ZeroStep Guidelines. This includes, a detached, single-family house, an apartment or an individual unit in a condominium complex or high rise. The certification can be for one-time or multiple-time use.

## What ZeroStep Does Not Certify

Presently, ZeroStep does not certify a community development.

## The Certification Process

For certifying an existing home, qualified ZeroStep personnel make a site visit and perform an in-home assessment. For certifying a floor plan, ZeroStep reviews the floor plans, and after the home is constructed, a site visit takes place.

Reviews are based on applicable state law, local ordinances and the ZeroStep Guidelines. The review identifies any barriers, and includes recommendations on how to best eliminate the barriers from the home or final construction documents, whichever the case may be. Upon completion of the recommended changes, the home or floor plan is awarded “ZeroStep Certification.”

## Why Obtain ZeroStep Certification?

For an architect, builder, and developer, the ability to advertise a home as “ZeroStep Certified” and use the ZeroStep logo says that you are not only about quality homes, but also about responsible and sustainable building. ZeroStep universally designed homes are a personal or company mindset, philosophy, and choice exceeding the standard perceptions of quality to include comprehensive home designs that enhance *all* stages of life for *everyone*.

For the home owner or buyer, ZeroStep Certification means that their home not only meets but exceeds current standards for residential construction. It also means they can expect a return on their investment because the home addresses not only today’s needs but tomorrow’s needs, as well as saving costs in remodeling or possibly relocating. A ZeroStep Certified Home is truly a home for a lifetime.

To learn more about the ZeroStep program, please call: 616.949.1100, ext. 255.

# Chapter 1. Exterior Accessible Routes and Spaces

## 101 Components of an Accessible Route and Accessible Home Design

**Accessible routes and entrances shall consist of all of the following components, if applicable, and shall comply with the appropriate sections of the ZeroStep Standards:**

- There shall be one accessible parking space on an accessible route to a zero-step entrance in accordance with Section 102.
- There is at least two zero-step exterior entrances on an accessible route to the home in accordance with Section 201; *and* there shall be no steps between an interior landing and the main level of the house in accordance with Section 201.4.
- Walking surfaces are not steeper than 1:20 (5%) in accordance with Section 104.
- Turning spaces shall be a circular space with a 60" minimum diameter in accordance with Sections 105, 301, 401, 501, 601, 701, and 801.
- Doors and doorways shall be 36" wide in accordance with Section 201.
- Ramps have a slope not steeper than 1:12 (8%) in accordance with Section 106.
- Elevators comply with the most recent ANSI A117.1 code.
- Hallways are a minimum of 42" wide in accordance with Section 202.
- Stairways are a minimum of 36" wide in accordance with Section 203.
- Clear floor space shall be 48" x 48" at fixtures in accordance with Sections 301, 501, 601, 701, 1201 and 1301.
- An accessible route shall connect the main floor bathroom, bedroom, kitchen, and living/family room.

**Accessible home design shall consist of all of the following components and shall comply with the applicable sections of the ZeroStep Standards:**

- There is at least one accessible, *full* size bathroom on the main floor, in accordance with Section 301.
- There is at least one accessible bedroom, on the main floor, near an accessible bathroom in accordance with Section 401.
- There is at least one accessible closet in accordance with Section 501.
- There is at least one accessible kitchen on the main floor in accordance with Section 601.
- There is an accessible laundry area in accordance with Section 701.
- There is at least one accessible living/family room on the main floor in accordance with Section 801.
- Exterior lighting is provided in accordance with Section 1101.
- The electrical panel box is accessible in accordance with Section 1201.
- The thermostat is accessible in accordance with Section 1301.

## 102 Parking and Driveways

### 102.1 Parking and Driveways.

There shall be one accessible parking space on an accessible route to a zero-step entrance. That portion of the driveway that may serve as the accessible parking area shall have a

maximum slope of 1:48 (2%) in all directions. That portion of the driveway that is part of any accessible route on the site shall have a maximum cross slope of 1:48 (2%) and a maximum running slope of 1:20 (5%).

## 102 OPTIONS.

### 102 Opt. 1 16' Minimum Width By 8' Minimum Length Loading/Unloading Zone.

There is at least a 16' wide by 8' minimum length loading/unloading zone with an accessible route to the home. (See Appendix A: 102 Opt. 1, p. 58.)

### 102 Opt. 2 Surface Materials.

The driveway is covered with a firm surface material, such as concrete or asphalt.

### 102 Opt. 3 24' Minimum Level Parking Space.

A minimum length of 24' of the driveway has a slope and cross slope of 1:48 (2%) to provide level parking space for cars.

## 103 Garage

### 103.1 Minimum Measurements – One Stall.

A one stall garage has a minimum of 16' clear width, 24' minimum depth. There is a minimum of a 5' width access aisle located on an accessible route into the home. There is a minimum of a 3' width access aisle on the opposite side of the vehicle. (See Fig. 103.1 and Appendix A: 103.1, p. 58.)

### 103.2 Minimum Measurements – Two Stall.

A two stall garage has a minimum of 27' clear width, 24' minimum depth. There is a minimum of a 5' width access aisle located on an accessible route into the home. There is a minimum of 3' width access aisles on the opposite sides of the vehicles. (See Fig. 103.2, p. 3 and Appendix A: 103.2, p. 59.)

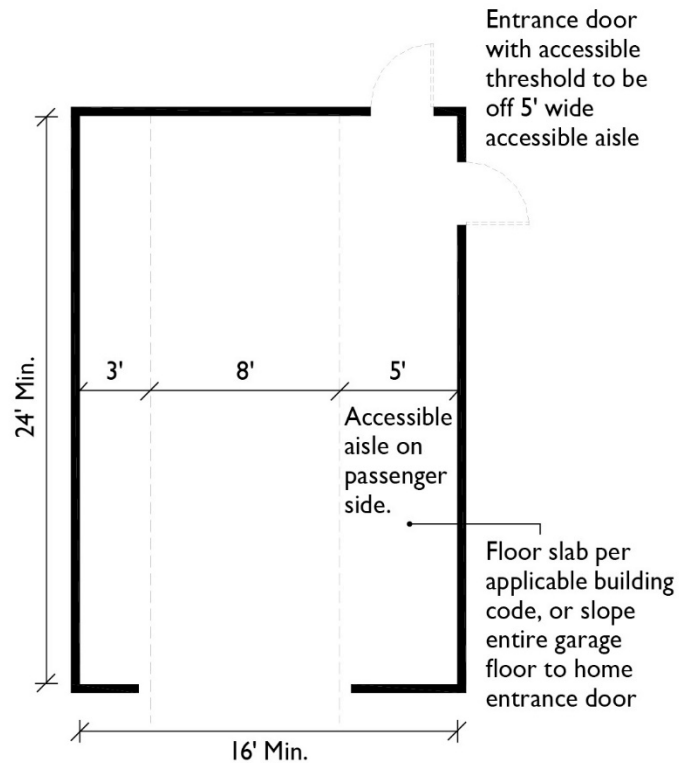

Garage door width is owner's option

FIG. 103.1 MINIMUM MEASUREMENTS  
ONE STALL GARAGE

## 103 OPTIONS.

### 103 Opt. 1 Slope Entire Garage Floor.

The entire garage floor is sloped so that entrance door into the home is accessed from the 5' access aisle and there is no greater than a ½" high, beveled threshold. (See Appendix A: 103 Opt. 3, p. 59.)

### 103 Opt. 2 Garage Ramp.

A ramp to the home entrance is installed in the garage with a slope no greater than 1:12 (8%). Comply with Section 106 Ramps.

### 103 Opt. 3 9' Minimum Garage Door Height.

The garage door is 9' high or higher. (See Appendix A: 103 Opt. 5, p. 59.)

### 103 Opt. 4 Electric Garage Door Opener.

An electric garage door opener is installed. (See Appendix A: 103 Opt. 6, p. 59.)

### 103 Opt. 5 Automatic Lighting.

Automatic or motion-activated lighting, other than the automatic light that comes with an electric garage door opener, is installed.

### 103 Opt. 6 Door Swing.

The house doors do not swing into the accessible route. (See Appendix A: 103 Opt. 8, p. 59.)

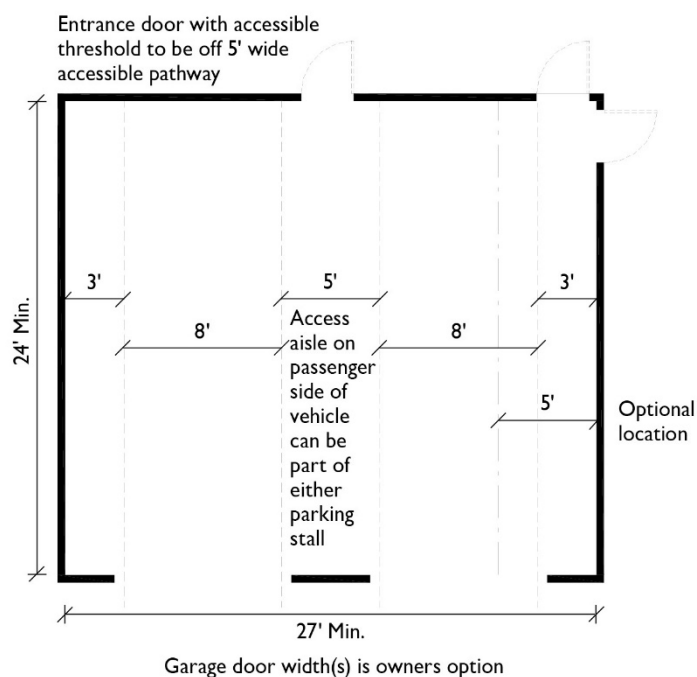

FIG. 103.2 MINIMUM MEASUREMENTS  
TWO STALL GARAGE

## 104 Walks and Pathways

### 104.1 Slope.

A primary walk or pathway to a zero-step entrance shall not be steeper than 1:20 (5%). If the primary walk or pathway is greater than 1:20, see Section 106 Ramps. (See Appendix A: 104.1, p. 59.)

### 104.2 Cross Slope.

The cross slope shall be a maximum of 1:48 (2%).



### 104.3 Changes in Level.

Any change in level shall follow the following guidelines:

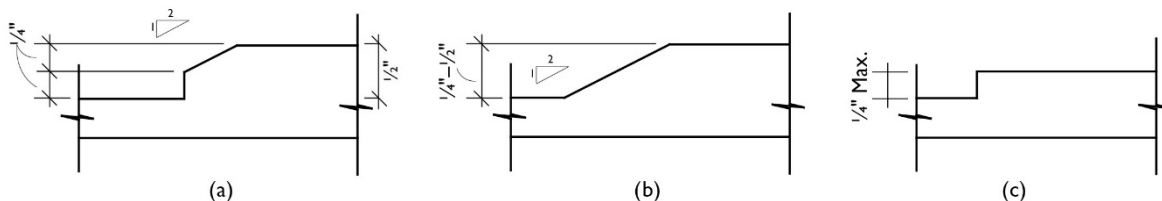

FIG. 104.3 CHANGES IN LEVEL

#### 104.3.1

Changes in level greater than 1/2" shall be beveled. (See Fig. 104.3 (a), p. 4.)

#### 104.3.2

Changes in level between 1/4" high and 1/2" high maximum shall be beveled with a slope not steeper than 1:2 (50%). (See Fig. 104.3 (b).)

#### 104.3.3

Changes in level of 1/4" high shall be permitted to be vertical. (See Fig. 104.3 (c).)

### 104.4 Clear Width.

A walk and pathway on an accessible route shall have a clear minimum width of 36" maintained throughout. (See Appendix A: 104.4, p. 60.)

### 104 OPTIONS.

#### 104 Opt. 1 Additional Walks or Pathways.

Additional walks or pathways to zero-step entrances are not steeper than 1:20 (5%).

#### 104 Opt. 2 Width Greater than 36".

Walks and pathways are greater than a clear width of 36".

#### 104 Opt. 3 Firm, Stable, Non-Slip Surface Materials.

Walks and pathways are covered with a firm, stable, non-slip surface material (concrete, asphalt, or lumber). (See Appendix A: 104 Opt. 3, p. 60.)

#### 104 Opt. 4 Sheltered Walkway.

The accessible walk or pathway between the vehicle and the home is sheltered overhead from the elements.

#### 104 Opt. 5 Lighting.

(See Section 1101 Opt. 1.)

## 105 Porches, Patios, Decks and Landings

### 105.1 Location.

Porches, patios, decks and exterior landings that are on the primary accessible entrance to the home shall comply with Section 201.2, 201.3 and 1101.1. (See Fig.105.1 and Appendix A: 105.1, p. 60.)

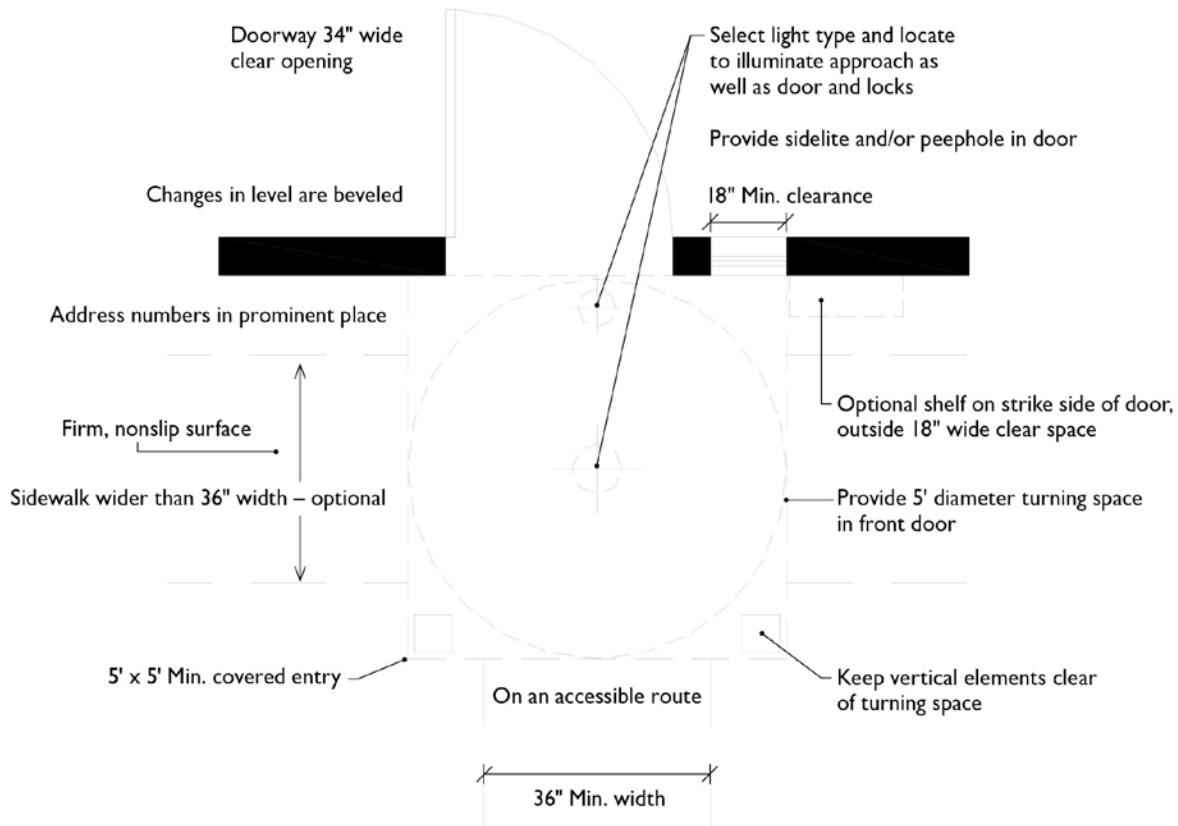

FIG. 105.1 PORCH

### 105.2 Turning Space.

The porch shall have at least a 5' diameter turning space in front of the primary door opening. (See Appendix A: 105.2, p. 60.)

### 105.3 Changes in Level.

Porches, patios, decks and landings that are on an accessible route shall comply with Section 104 Walks and Pathways, 104.3.1 – 104.3.3.

### 105.4 Openings.

Deck boards shall be spaced no more than ¼" apart.

## 105 OPTIONS.

### 105 Opt. 1 Shelf.

A built-in shelf or ledge is located on the strike side of an accessible door. (See Appendix A: 105 Opt. 1, p. 60.)

### 105 Opt. 2 Address Numbers.

The house address numbers are a minimum of 4" high, high contrast or reflective material or lighted, and located in a prominent place on the house and/or the mailbox, easy for friends and emergency personnel to locate.

### 105 Opt. 3 Primary Covered Entry.

A 5' x 5' minimum covered entry (e.g., awning, covered porch) shall be provided at the primary zero-step entrance. A garage roof is an acceptable solution if the accessible entrance is through the garage.

### 105 Opt. 4 All Covered Entries.

A covered entry is provided at all zero-step entries.

### 105 Opt. 5 Door Bells.

Door bell installed at more than one entrance.

## 106 Ramps (See local codes first.)

### 106.1 When to Install a Ramp.

A ramp is installed when the walking slope is greater than 1:20 (5%). (See Appendix A: 106 General Information, p. 60.)

### 106.2 Slope.

The ramp slope shall not be steeper than 1:12 (8%). (See Appendix A: 106.2, p. 60.)

### 106.3 Cross Slope.

The cross slope shall be a maximum of 1:48 (2%) or less.

### 106.4 Clear Width.

The clear width of a ramp run shall be a minimum of 42" to a maximum of 48". Code allows a clear ramp width of 36" but this should be used in rare circumstance. (See Fig. 106.4 and Appendix A: 106.4, p. 61.)

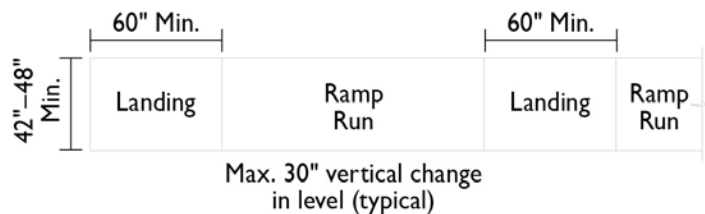

FIG. 106.4 RAMP CLEAR WIDTH

### 106.5 Rise.

The rise shall be 30" maximum between landings, and preferably less. (See Appendix A: 106.5, p. 61.)

## 106.6 Landings.

Ramps shall have landings at the bottom and top of each ramp run. The landing at the bottom need not be the same material as the ramp run, however it must be a hard surface, e.g. concrete. A ramp run shall not exceed 30' maximum, preferably 24', in length between landings.

### 106.6.1 Landing Slope.

Landings shall slope 1:48 (2%) or less. Changes in level are not permitted.

### 106.6.2 Landing Clear Width.

Clear width of landings shall be at least as wide as the widest ramp run leading to the landing.

### 106.6.3 Landing Length.

The landing length shall be 60" minimum. (See Fig. 106.4.)

### 106.6.4 Landing Change in Direction - 90° Turn.

A ramp that makes a 90° turn shall have a minimum 5' x 5' landing. (See Fig. 106.6.4.)

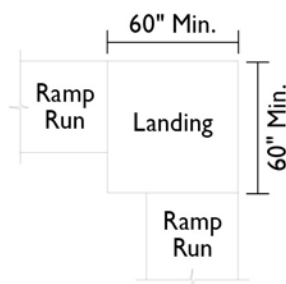

FIG. 106.6.4 RAMP LANDING CHANGE IN DIRECTION - 90° TURN

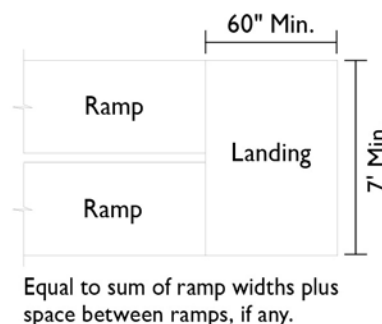

FIG. 106.6.5 RAMP LANDING CHANGE IN DIRECTION - 180° TURN

### 106.6.5 Landing Change in Direction - 180° Turn.

A ramp that makes a 180° turn shall have a minimum 7' landing length which is equal to the sum of the ramp widths plus space between ramps, if any, by 5' landing width. (See Fig. 106.6.5.)

### 106.6.6 Landings for a Child.

Due to personal needs for a child, a home owner may customize the landing.

## 106.7 Edge Protection.

Edge protection shall comply with Section 1010.9.1 or 1010.9.2 of the Michigan Building Code. (See Appendix A: 106.7, p. 61).

## 106.8 Handrails.

Ramps with a rise greater than 6" shall have graspable handrails. Handrail height, measured above the finished surface of the ramp slope, shall be not less than 34" and not more than 36". (See Fig. 106.8.)

**106.8.1 Handrail Location.**

Handrails shall be provided on both sides of ramp.

**EXCEPTION:** Ramps that are parallel and attached to the home or garage may have one continuous handrail on the side opposite the home or garage.

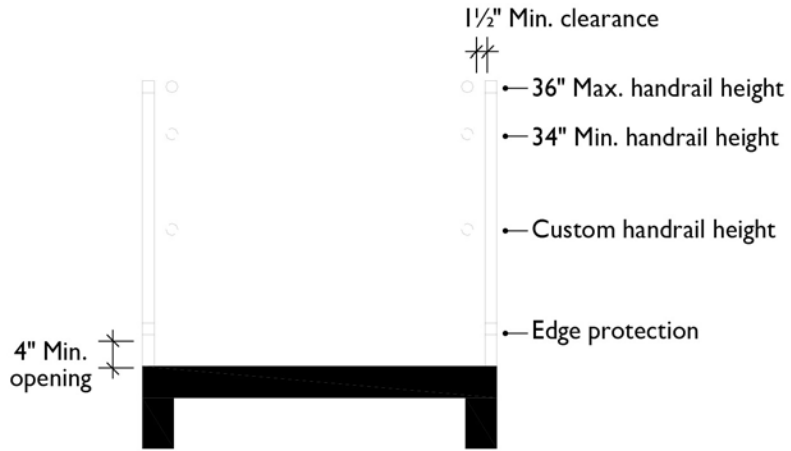

FIG. 106.8 RAMP HANDRAILS

**106.8.2 Handrail Continuity.**

Handrails shall be continuous.

**106.8.3 Balusters.**

The space between balusters shall not exceed 4".

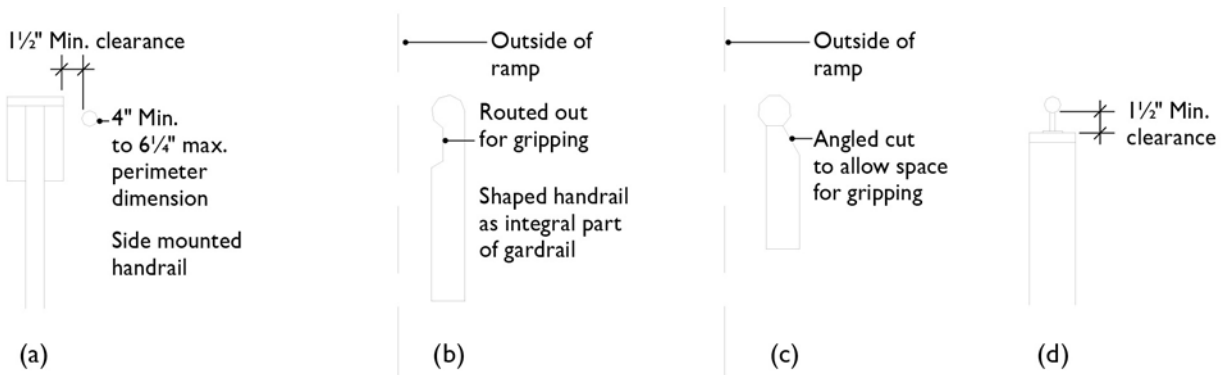

FIG. 106.9 RAMP HANDRAIL CLEARANCE AND GRASPABILITY

**106.9 Handrail Clearance and Graspability.**

The handrail clearance shall be 1/2" minimum from an adjacent surface. Handrails with a circular cross section shall have a perimeter dimension of 4" minimum and 6 1/4" maximum, and a cross-section dimension of 2 1/4" maximum. (See Fig. 106.9 (a)–(d).)

**106.10 Outdoor Conditions.**

Outdoor ramps and outdoor approaches to ramps shall be designed so that water will not accumulate on walking surfaces.

### 106.11 Ramp Surface.

The ramp surface shall be of slip-resistant material that is securely attached, or a brushed concrete surface. Decking shall be installed perpendicular to the path of travel with at least 1/8" gaps between boards to allow for drainage.

### 106 OPTIONS.

#### 106 Opt. 1 No Ramp Required.

No ramp is required.

#### 106 Opt. 2 Second Graspable Handrail.

A second graspable handrail is installed. The second handrail is continuous for the full length of the ramp, and does not reduce the clear ramp width.

#### 106 Opt. 3 Slope Less Than 1:12 (8%).

The ramp slope is less than 1:12 (8%).

#### 106 Opt. 4 Ramp Run 24' or Less.

A ramp run of 24' or less is installed, while adhering to Guideline 106.2 requiring the ramp slope not be steeper than 1:12 (8%). (See Appendix A: 106.5, p. 61.)

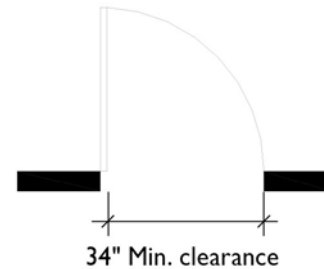

FIG. 201.2 DOOR CLEAR WIDTH

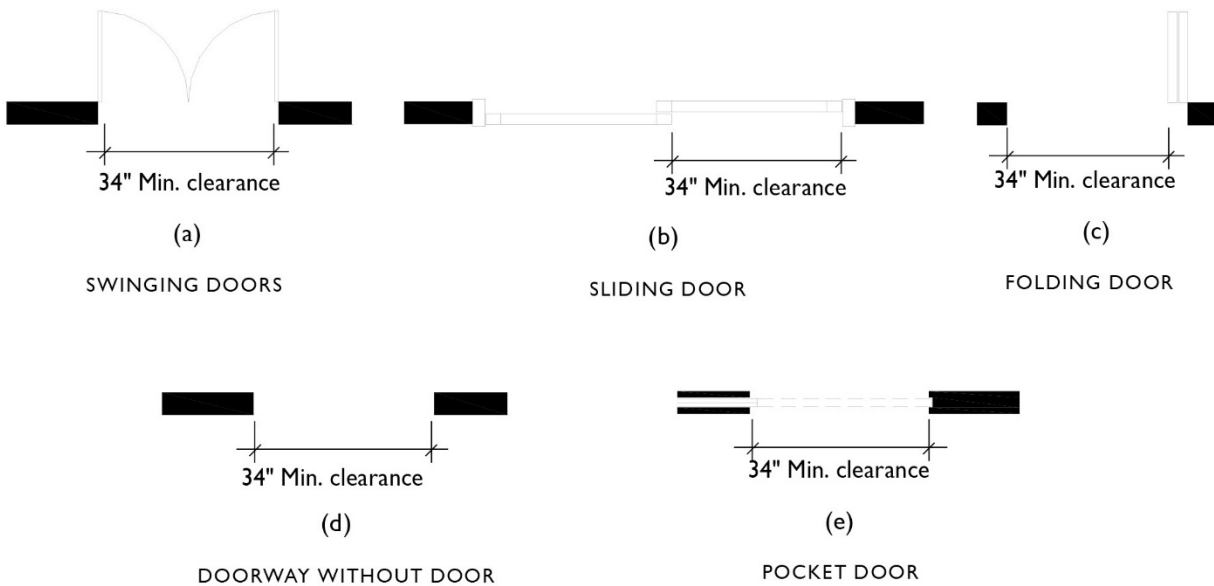
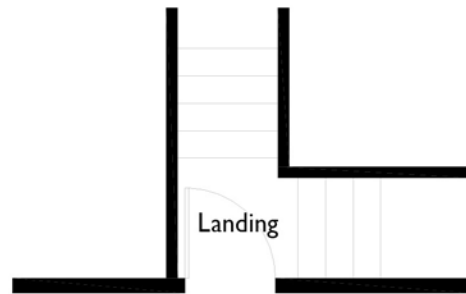

FIG. 201.4 DOORS

## Chapter 2. Interior Accessible Routes and Spaces

Interior Accessible Route begins at the exterior entrance to the home.

### 201 Doors and Doorways



A split level landing is **NOT** permitted at a zero-step entrance.

FIG. 201.5 SPLIT LEVEL LANDING

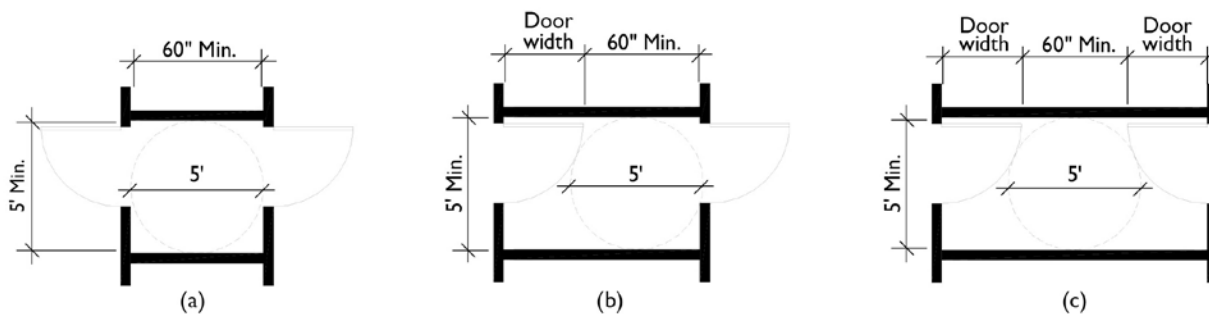

FIG. 201.6 TWO DOORS IN SERIES

#### 201.1 Zero-Step Exterior Entrance.

There shall be two or more zero-step exterior entrance on an accessible route to the home, and shall comply with Sections 104.3 and 1101.1. (See Fig. 104.3.)

#### 201.2 Clear Width.

Doors and doorways that are on an accessible route shall have a clear opening width of 34" minimum which is typically accomplished by a 36" wide door. (See Fig. 201.2.)

#### 201.3 Minimum Maneuvering Clearances.

Having a clear maneuvering space that is a minimum of 18" on the push and pull side of a door. (See Fig. 201 Opt. 2.)

#### 201.4 Swinging Doors, Sliding and Folding Doors, Doorways Without Doors and Pocket Doors.

Swinging doors, sliding and folding doors, doorways without doors and pocket doors that are on an accessible route shall have a clear opening width of 34" minimum. (See Fig. 201.3 (a)-(e).)

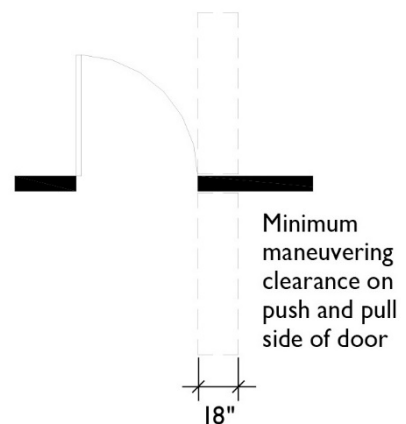

FIG. 201.3 18" MINIMUM MANEUVERING CLEARANCE

**EXCEPTION:** Pantries and closets other than accessible closets addressed in Section 201 may have less than a clear opening width of 34".

**201.5 Changes in Level.**

Doors and doorways that are on an accessible route shall comply with Section 104.3.1 – Section 104.3.3.

**201.6 Split Level Landing.**

No split level landings are permitted at a zero-step entrance into the home. For example, a “back landing” where the exterior door swings over a landing and there are additional steps to climb before reaching a kitchen is not allowed. (See Fig. 201.5.)

**201.7 Two Doors in Series.**

Minimum maneuvering clearances shall be at double doors on an accessible route. Door swings shall not infringe on the 5' turning space. (See Fig. 201.6(a)-(c).)

**201 OPTIONS.**

**201 Opt. 1 Sidelite.**

Primary entrance door with one or two sidelites or a primary entrance door with a window is installed so that a person has visibility from a seated position. (See Appendix A: 201 Opt. 3, p. 61.)

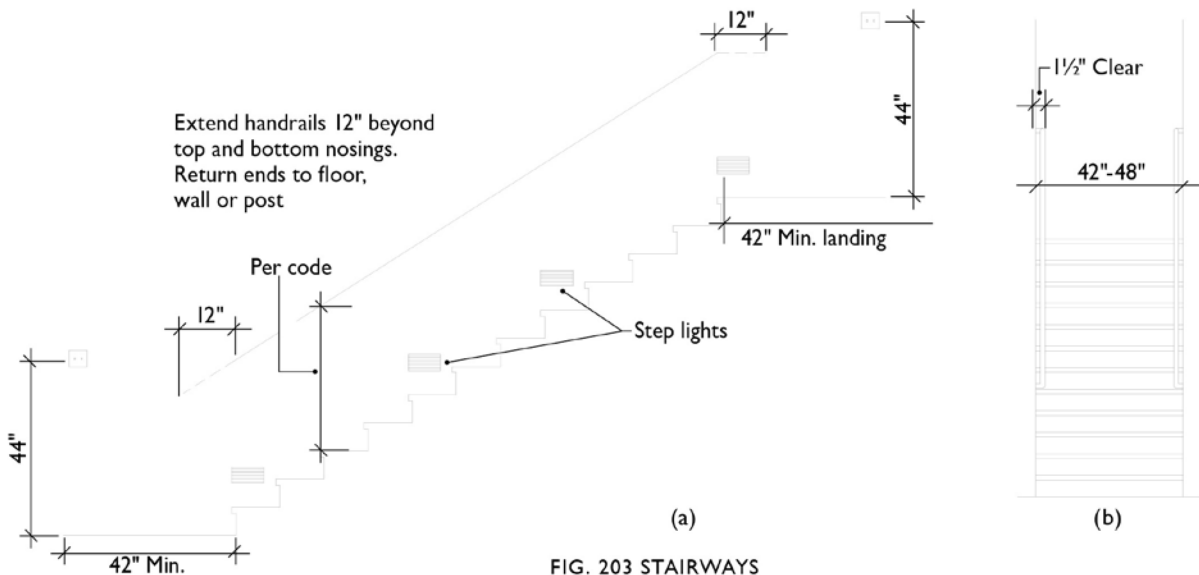

**201 Opt. 2 Lever Door Hardware.**

Lever hardware is used on all doors of the dwelling. (See Appendix A: 201 Opt. 4, p. 61.)



### **201 Opt. 3 Automatic Door Opener.**

An automatic door opener is installed on an accessible door. This does not include an electric garage door opener. (See Appendix A: 201 Opt. 5, p. 62.)

## **202 Hallways**

### **202.1 Width.**

A 42" minimum width hallway is required on an accessible route.

### **202.2 Changes in Level.**

Shall comply with Section 104.3.1 – Section 104.3.3.

### **202 OPTIONS.**

#### **202 Opt. 1 Width Greater Than 42".**

Greater than a 42" width hallway is provided.

## **203 Stairways**

### **203.1 Interior Landing at Exterior Doorway.**

Shall comply with Section 201.4.

### **203.2 Stairway Lighting.**

All interior and exterior stairways shall be provided with a means to illuminate the stairs, the landings and treads. Interior stairways shall be provided with an artificial light source located in the immediate vicinity of each landing of the stairway. (See Fig. 203 (a) and Appendix B: 203.2, p. 116.)

**EXCEPTION:** An artificial light source is not required at the top and bottom landing, provided an artificial light source is located directly over each stairway section.

### **203.3 Lighting Controls.**

The control for activation of the required interior stairway light shall be accessible at the top and bottom of each stairway without traversing any steps. The illumination of exterior stairways shall be controlled from inside the dwelling unit. (See Fig. 203 (a) and Appendix B: 1201.3, p. 155.)

**EXCEPTION.** Lights that are continuously illuminated or automatically controlled.

### **203 OPTIONS.**

(See Sections 901 Flooring Options and Fig. 203 (a) and (b).)

#### **203 Opt. 1 No Open Risers.**

Open risers are not installed on interior stairways. (See Appendix A: 203 Opt. 1, p. 62.)

**203 Opt. 2 Increased Width.**

Stairways on an accessible route are a minimum of 42" wide to a maximum of 48" wide above the handrail.

**203 Opt. 3 Deeper Treads and Lower Risers.**

Treads and risers on stairs have uniform riser height and uniform tread depth. Risers are between 4" minimum and 7" maximum in height. Treads are 11" minimum in depth. (See Appendix A: 203 Opt. 3, p. 62.)

**203 Opt. 4 Landings or Clear Floor Space Exceed Minimums.**

There is a landing or clear floor space at the top and bottom of the stairway. The landing or clear floor space width is not less than the stairway served, and is a minimum dimension of 42" in the direction of travel. (See Fig. 203 (a).)

**203 Opt. 5 Two Handrails.**

Handrails are provided on both sides of the stairway. (See Fig. 203 (b).)

**203 Opt. 6 Handrail Extension.**

At the top and bottom of a stair flight, the handrails extend beyond the landing 12 inches. (See Fig. 203 (a).)

**203 Opt. 7 Handrail Terminations.**

At the top and bottom of a stair flight, the handrail ends are returned to the floor, wall or post. (See Fig. 203 (a) and Appendix A: 203 Opt. 7, p. 62.)

**203 Opt. 8 Wall Reinforcement for Additional Custom Height Handrail.**

Wood 2x blocking is installed for custom height handrail.

**203 Opt. 9 Lighting Along Length.**

Theatre lights, cove lighting, tread lights, wall lights or similar lights are installed along the length of the stairway to provide adequate lighting on each tread. See Section 1201 Opt. 4. and Opt. 7. (See Fig. 203 (a).)

**203 Opt. 10 Electrical Outlets.**

Electrical outlets are in place at the top and bottom landings for future stair lift or incline platform lift.

**203 Opt. 11 Stair-Lift or Incline Platform Lift.**

A stair-lift or incline platform lift is installed. (See Appendix A: 203 Opt. 11, p. 62.)

## 204 Elevators

### 204 OPTIONS.

#### **204 Opt. 1 Stacked Walk-In Closets.**

A 5' x 5' clear interior dimension for “stacked” walk-in closets for a future elevator is constructed. (See Appendix A: 204 Opt. 1, p. 63.)

#### **204 Opt. 2 Elevator Installed.**

A residential elevator is installed.

## 205 Balconies, Lofts, Raised or Sunken Areas and Split-Level Entries

### **205.1 Balconies, Lofts, Raised or Sunken Areas and Split-Level Entries.**

Balconies, lofts, raised or sunken areas and split-level entries are not recommended, however if they are designed into a dwelling, they must not interfere with the accessible route or with accessible bathroom, kitchen and living room.

### 205 OPTIONS.

#### **205 Opt. 1 No Balconies, Lofts, Raised or Sunken Areas and Split Entries.**

No balconies, lofts, raised or sunken areas and split entries are installed.

## Chapter 3. Bathrooms

### 301 Bathrooms

#### 301.1 Location.

There shall be at least one full size bathroom (consisting of a sink, toilet, and bathtub or shower) on the main floor, on an accessible route, near an accessible bedroom. (See Appendix A: 301.1, p. 63.)

#### 301.2 Turning Space.

There shall be a 5' diameter turning space. The turning space may overlap approaches at fixtures and doorway swings. (See Fig. 301.2 and Appendix A: 301.2, p. 63.)

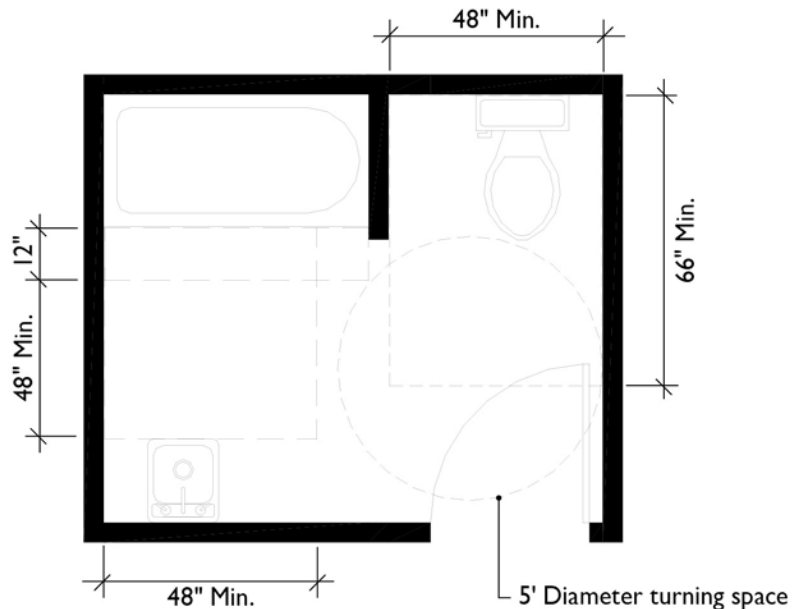

FIG. 301.2 BATHROOM TURNING SPACE AND CLEAR FLOOR SPACE

#### 301.3 Clear Floor Space.

A 48" x 48" minimum clear floor space shall be provided at the sink, bathtub and shower. Only 19" of the 48" clear floor space may extend under the sink. The 48" x 48" clear floor spaces may overlap and include the toe kick space. (See Fig. 301.3 and Appendix A: 301.3, p. 63.)

**EXCEPTION:** Where a 48" x 48" clear floor space cannot be provided, a 32" x 48" minimum clear floor space shall be permitted with two provisions: the 32" x 48" clear floor space must be positioned parallel to the fixtures and provide sufficient floor space to enlarge to a 48" x 48" clear floor space without moving perimeter bathroom walls. This will require changing fixtures or cabinetry. (See Fig. 301.3 Exception.)

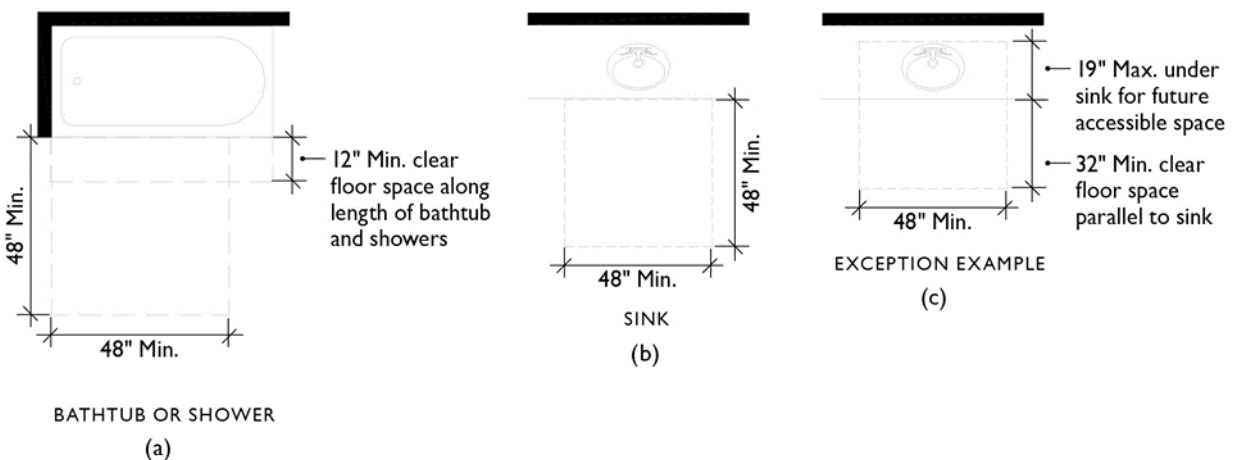

FIG. 301.3 BATHROOM CLEAR FLOOR SPACE

### 301.4 Toilet Clear Floor Space.

A clear floor space around the toilet of 48" minimum, measured perpendicular from the side wall, and 66" minimum, measured perpendicular from the rear wall, shall be provided. The required clearance around the toilet shall be permitted to overlap other fixture clear floor spaces. (See Fig. 301.4 and Appendix A: 301.4, p. 63.)

**EXCEPTION:** Where a 48" x 66" clear floor space cannot be provided, a 32" x 48" minimum clear floor space shall be permitted with two provisions: the 32" x 48" clear floor space must be positioned parallel to the front of the toilet rim and provide sufficient floor space to enlarge to a 48" x 66" clear floor space without moving perimeter bathroom walls. This will require changing fixtures or cabinetry.

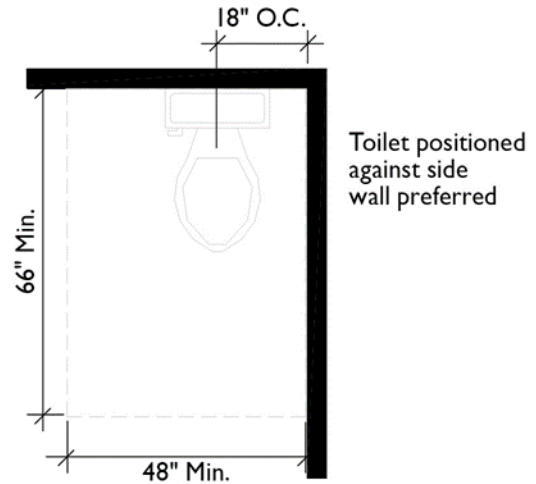

FIG. 301.4 BATHROOM TOILET CLEAR FLOOR SPACE

### 301.5 Doors.

Doors shall comply with Section 201.

### 301.6 Wall Reinforcement.

Walls shall be reinforced with 2x blocking concealed in the wall for future grab bar placement around toilets, bathtubs, showers and for slide bar, hand held showers. Allowable stresses shall not be exceeded for materials used where a vertical or horizontal force of 250 pounds is applied at any point when grab bars are installed. (See Fig. 301.6 and Appendix A: 301.6, p. 63.)

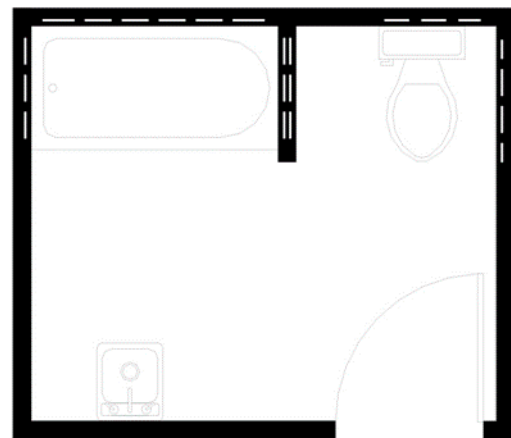

FIG. 301.6 BATHROOM WALL REINFORCEMENT & GRAB BAR LOCATIONS

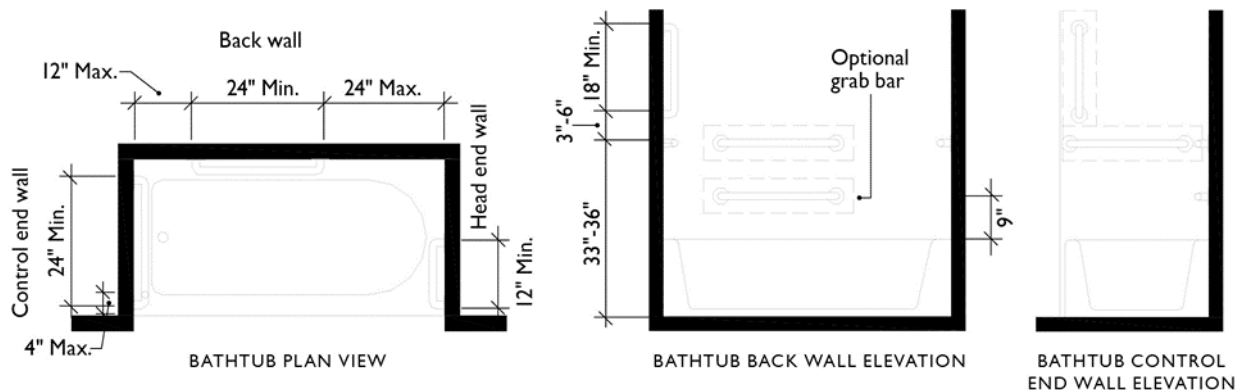

FIG. 301.6 BATHROOM WALL REINFORCEMENT

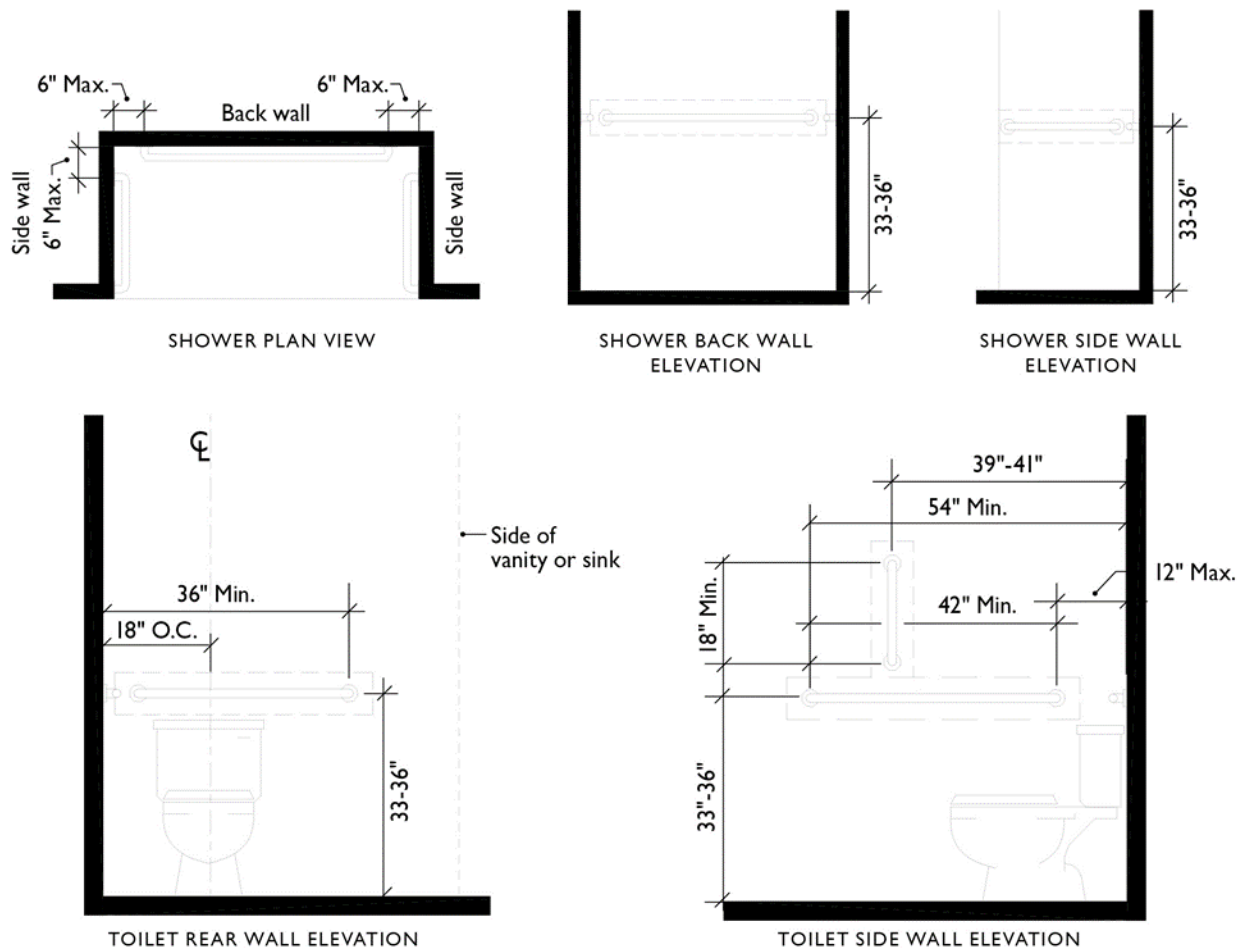

FIG. 301.6 BATHROOM WALL REINFORCEMENT

### 301.7 Wall Reinforcement Documentation.

Wall reinforcement documentation for installation of future grab bars shall be provided. (See Appendix A: 301 Opt. 7, p. 63.)

### 301.8 Bathtub/Shower Stall 12" Deep Clear Floor Space.

A 12" minimum clear floor space shall be provided along the entire length of a bathtub and/or a shower stall according to Table 301.11, p. 18. (See Fig. 301.3 (c) and Appendix A: 301.8, p. 64.)

### 301.9 Bathtub Height.

On-slab construction shall not increase the height of the bathtub. (See Appendix A: 301.9, p. 64.)

### 301.10 Toilet.

The toilet shall be positioned with a wall to the rear and a wall to one side. The centerline of the toilet shall be 18" on center from the side wall. If the toilet cannot be positioned against a wall to one side, the rear wall must have wall reinforcement with blocking for a future pull-down grab bar. Note: the side wall must be of adequate height, depth and strength for future grab bar installation. (See 301.4 Exception, Fig. (s) 301.2 & 301.4 and Appendix A: 301.10, p. 64.)

### 301.11 Shower Stall.

A minimum shower stall shall be 36" x 36". Shower stalls must comply with Shower Stall Approaches Table 301.11. (See Appendix A: 301.11, p. 65.)

Table 301.11 Shower Stall Approaches	
Shower Size	Approach
30"D x 60"W	Follow 301.3 and 301.8
36"D x 36"W	Follow 301.3 and 301.8
36"D x 48"W	Follow 301.3 and 301.8
32"D x 60"W	Follow 301.3 and 301.8
36"D x 60"W	Follow 301.3 and 301.8
40"D x 60"W	Follow 301.3 and 301.8
48" x 48"	Follow 301.3
48" x 60"	Follow 301.3
Corner Angled Shower 36", 38" & 40"	Follow 301.3
Round Base 36" & 40"	Follow 301.3

### 301.12 Sink Cabinet.

A minimum of a 36" wide cabinet shall be permitted under the bathroom sink, provided the counter top shall be self supportive and the base cabinet under the sink be in-fill. A cabinet without a center stile is recommended. (See Appendix A: 301.12, p. 65.)

### 301.13 Exposed Pipes.

Where knee space is provided under sinks, exposed pipes and surfaces shall be insulated or configured to protect against contact. There shall be no sharp or abrasive surfaces under sinks. (See Appendix A: 301.13, p. 65.)

### 301 OPTIONS.

(See Sections 901 Flooring Options, 1001 Window Options, 1101 Lighting Options, 1201 Lighting Controls Options and 1401 Technology Options.)

#### 301 Opt. 1 Accessible Half-Bath – Main Floor.

An additional accessible half-bath is provided on the main floor and on an accessible route.

#### 301 Opt. 2 2nd Accessible Full-Size Bath – Main Floor.

A second full-size, accessible bathroom (consisting of a sink, toilet, and bathtub or shower) is provided on the main floor and on an accessible route. (See Appendix A: 301 Opt. 2, p. 65.)

#### 301 Opt. 3 Accessible Half-Bath/Full Bath – Second Floor.

An accessible half bath or full bath is provided on an alternate level of home.

#### 301 Opt. 4 No Doors Swing Into 5' Turning Space.

No doors swing into 5' diameter turning space. (See Appendix A: 301 Opt. 4, p. 65.)

#### 301 Opt. 5 Bathroom Doors Swing Out.

Bathroom doors swing out of the accessible bathroom space or pocket doors are used, in accordance with Section 201. (See Appendix A: 301 Opt. 5, p. 65.)

**301 Opt. 6 Wall Reinforcement Extended.**

Wood blocking is extended beyond Section 301.6 requirements and/or includes wood blocking for future child-height grab bars. (See Appendix A: 301 Opt. 6, p. 65.)

**301 Opt. 7 Wall Reinforcement Document Permanent Installation.**

The wall reinforcement document is permanently installed in the bathroom for future homeowners to review. (See Appendix A: 301 Opt. 7, p. 65.)

**301 Opt. 8 Grab Bars Installed.**

Grab bars are installed in the bathtub and/or shower area, and toilet areas, on reinforced walls that can support up to 250 pounds of downward force. (See Appendix A: 301 Opt. 8, p. 66.)

**301 Opt. 9 Comfort Height Toilet.**

A comfort height toilet with a rim between 17" and 19" high, above the floor is installed. (See Appendix A: 301 Opt. 9, p. 66.)

**301 Opt. 10 Bidet or Toilet Seat with Bidet Functionality.**

A bidet or toilet seat with bidet functionality is installed. (See Appendix A: 301 Opt. 10, p. 66.)

**301 Opt. 11 Mirror Mounting Height.**

Mirrors above sinks are mounted with the bottom edge of the reflecting surface no higher than 40" above the finished floor. (See Appendix A: 301 Opt. 11, p. 66.)

**301 Opt. 12 Mirror Types.**

Full length mirrors, tilt mirrors, mirrors that turn, split-angle mirrors, or magnifying mirrors are installed.

**301 Opt. 13 Shut-Off Valves.**

Shut-off valves are easily reached from a seated position. (See Appendix A: 301 Opt. 13, p. 66.)

**301 Opt. 14 Toe Clearance.**

There is a 9" high toe clearance on base cabinets.

**301 Opt. 15 Space Under Sink.**

In accessible bathrooms, wall-hung, pedestal, or exposed basin sinks (exposed sink front on a vanity) shall be installed with a minimum of a 27" space from above the finished floor to underneath the bowl of the sink. The drain shall be placed toward the back of the fixture rather than the middle. (See Appendix A: 301 Opt. 15, p. 66.)

**301 Opt. 16 Sink Height Between 32"–34".**

The front of a sink, including vessel sink, is between 32"-34" at the rim above the finished floor.



**301 Opt. 17 Levers or Handle on Faucet Control.**

Dual or single levers or handle are installed. Single lever handle is preferred. (See Appendix A: 301 Opt. 17, p. 67.)

**301 Opt. 18 Sink Faucet Location.**

Faucet hardware is mounted on the side of the sink, rather than at the back. (See Appendix A: 301 Opt. 18, p. 67.)

**301 Opt. 19 Motion Activated Faucets.**

Motion activated faucets are installed.

**301 Opt. 20 Scald Guard.**

A scald guard valve or mixing valves are installed. (See Appendix A: 301 Opt. 20, p. 67.)

**301 Opt. 21 Bathtub 36" Deep Clear Floor Space.**

36" deep or greater clear floor space is provided along the entire length of the bathtub. (See Appendix A: 301 Opt. 21, p. 67.)

**301 Opt. 22 Bathtub Height.**

The bathtub height does not exceed 16" above the finished floor. (See Appendix A: 301 Opt. 22, p. 67.)

**301 Opt. 23 Accessible Bathtub.**

An accessible walk-in bathtub is installed. (See Appendix A: 301 Opt. 23, p. 67.)

**301 Opt. 24 Bathtub/Shower Faucet Control Location.**

Controls are repositioned closer to the bathtub or shower stall front rim/edge so they are easily reached. (See Appendix A: 301 Opt. 24, p. 67.)

**301 Opt. 25 Hand Held Shower.**

A hand held shower head, on an adjustable slide bar with a hose at least 6' long, is installed on a reinforced wall in the bathtub and/or the shower. (See Appendix A: 301 Opt. 25, p. 67.)

**301 Opt. 26 Additional Shower Controls.**

More than one set of controls are installed within easy reach in the shower compartment.

**301 Opt. 27 Acrylic Bathtub/Shower Wall Reinforcement.**

Manufactured reinforced acrylic bathtub/shower walls are installed with no dead air space between the unit and adjacent walls, which could negatively impact future grab bar installation.

**301 Opt. 28 Non-Conventional Bathtubs.**

Non-conventional bathtubs, whirlpools and saunas follow Sections 301.2, 301.3, 301.5, 301.6, 301.7, 301.8, and 301.9.

**301 Opt. 29 Walk-In Shower Stall.**

A minimum of a 36" x 36" walk-in shower stall is installed.

**301 Opt. 30 Wet Room.**

A wet room bathroom meeting bathroom prerequisites is provided.

**301 Opt. 31 Shelving.**

Built-in or recessed shelving is installed at the front corner, closest to the bathroom fixture controls, or on the side wall, where it does not interfere with future grab bars. (See Appendix A: 301 Opt. 31, p. 68.)

**301 Opt. 32 Telephone Jack.**

A telephone jack is installed in the bathroom. (See Appendix A: 301 Opt. 32, p. 68.)

**301 Opt. 33 Counter/Cabinet Switches and Outlets.**

Switches and outlets are easy to reach near the end of the counter and/or are placed at the front edge of base cabinets (See Fig. 601 Opt. 26 and Appendix A: 601 Opt. 25, p. 72); and/or switches and outlets are no more than 21" from the front counter edge on a side wall. (See Fig. 601 Opt. 27.)

**301 Opt. 34 Extending Flooring Under Removable Cabinets.**

Extending a finished flooring material, such as wood, tile, or vinyl, under removable bathroom cabinets is provided.

## Chapter 4. Bedrooms

### 401 Bedrooms

#### **401.1 Location.**

There shall be at least one bedroom on an accessible route, on the main floor, near an accessible bathroom. (See Appendix A: 401.1, p. 68.)

#### **401.2 Turning Space.**

There shall be a clear 5' diameter turning space close to the bedroom entrance door, unobstructed by furniture or furnishings.

#### **401.3 Doors.**

Doors shall comply with Section 201.

#### **401 OPTIONS.**

(See Sections 901 Flooring Options, 1001 Window Options, 1101 Lighting Options, 1201 Lighting Controls Options and 1401 Technology Options.)

#### **401 Opt. 1 Additional Main Floor Accessible Bedroom.**

An additional accessible bedroom or room that can be converted into a second bedroom is provided on an accessible route on the main floor.

#### **401 Opt. 2 Additional Alternate Floor Accessible Bedroom.**

An additional accessible bedroom or room that can be converted into a second bedroom is provided on an accessible route on an alternate floor.

#### **401 Opt. 3 Emergency Escape Window Exceeds Michigan Building Code.**

An emergency escape window which exceeds the Michigan Building Code as follows, (with a sill height between 20" and 30", a minimum net clear opening width of 30", and exceeds 5.7 square feet) is installed. (See Appendix A: 401 Opt. 3, p. 68.)

#### **401 Opt. 4 Exterior Emergency Escape Door.**

An exterior emergency escape door is installed. The door shall comply with Section 201.1 – 201.5. (See Appendix A: 401 Opt. 4, p. 68.)

#### **401 Opt. 5 2 Additional Outlets on Bed Wall.**

The wall that will likely have a bed along it shall have least two outlets (one receptacle box) on each side of the bed or ideally four outlets (two receptacle boxes) on each side of the bed. (See Section 1201 Opt. 3 and Appendix A: 401 Opt. 5, p. 69.)

#### **401 Opt. 6 Bedside Switch Outlet.**

A switched outlet for the bedroom light is installed with a switch at the entrance and another at bedside. (See Section 1201 Opt. 4 and Appendix A: 401 Opt. 6, p. 69.)

#### **401 Opt. 7 Auxiliary Wiring.**

Accessible bedroom(s) is wired for any of the following: telephone jacks, cable television and/or internet/computer. (See Appendix A: 401 Opt. 7, p. 69.)

## Chapter 5. Closets

### 501 Closets

#### **501.1 Location.**

One accessible closet is in an accessible bedroom.

#### **501.2 Clear Floor Space.**

A 48" x 48" minimum clear floor space is in front of a wall closet.

#### **501.3 Doors.**

Shall comply with Section 201. Closet doors may overlap the 48" x 48" clear floor space.

#### **501.4 Lighting.**

Lighting shall be installed in accessible walk-in closets in accordance with Michigan Residential Code E3903.11.

### **501 OPTIONS.**

#### **501 Opt. 1 Two or More Additional Accessible Closets.**

Two or more additional accessible closets are provided on an accessible route.

#### **501 Opt. 2 Overhead/Recessed Door Mounting Hardware.**

Accessible closet door hardware is suspended from above or tracks are recessed into the floor for sliding doors. See Section 201.5 and Sections 103.3.10 – 103.3.3.

#### **501 Opt. 3 Walk-In Closets With 5' Turning Space.**

Walk-in closets have a 5' diameter turning space within the closet, or have a 42" minimum wide clear aisle within or through the closet. (See Appendix A: 501 Opt. 3, p. 69.)

#### **501 Opt. 4 Adjustable Rods.**

One or more adjustable rods at different heights and/or a pull down rod is installed. (See Appendix A: 501 Opt. 4, p. 69.)

#### **501 Opt. 5 Shelves.**

Some shelves are between 15" and 48" in height from the finished floor. (See Appendix A: 501 Opt. 5, p. 69.)

#### **501 Opt. 6 Pull-Out or Pull Down Shelves.**

Pull-out wire baskets or custom built pull-out shelves, and/or pull down shelves are installed. (See Appendix A: 501 Opt. 6, p. 69.)

#### **501 Opt. 7 Drawers.**

Drawers are installed in an accessible closet. (See Appendix A: 501 Opt. 7, p. 70.)

#### **501 Opt. 8 Closet Carrousel.**

An automated closet carrousel is installed.

## Chapter 6. Kitchens

### 601 Kitchens

#### **601.1 Location.**

There shall be at least one accessible kitchen on the main floor on an accessible route.

#### **601.2 Doors.**

Doors and doorways shall comply with Section 201.

#### **601.3 Turning Space.**

There shall be a 5' diameter turning space within the kitchen area. The turning space may overlap approaches at fixtures.

**EXCEPTION:** A galley kitchen may have a minimum 48" clearance between all opposing base cabinets, countertops, appliances or walls, with a 5' diameter turning space at either end.

An island may have a minimum 48" clearance between all opposing base cabinets, countertops, appliances or walls measured beneath the counter, with a 5' diameter turning space located in the kitchen.

#### **601.4 Clear Floor Space.**

A 48" x 48" minimum clear floor space shall be provided at ranges, cooktops, ovens, wall-mount ovens, dishwashers, kitchen sinks, microwave ovens, pantries, refrigerators, and trash compactors. The approaches may overlap.

##### **601.4.1 Sink.**

The centerline of the sink shall align with the centerline of the clear floor space.

##### **601.5 Sink Cabinet.**

A minimum of a 36" wide cabinet shall be permitted under a kitchen sink or cooktop, provided the cabinetry can be removed. (See Appendix A: 601.5, p. 70.)

##### **601.6 Counter Width.**

A minimum 18" width of counter space is located near all ovens and the refrigerator. (See Appendix A: 601.6, p. 70.)

##### **601.7 Sink Exposed Pipes and Surfaces.**

Water supply and drain pipes under sinks shall be configured to protect against contact. There shall be no sharp or abrasive surfaces under sinks. (See Appendix A: 601.7, p. 70.)

##### **601.8 Underneath Range/Cooktop Exposed Hot Surfaces.**

Where knee space is provided, the underside of the range or cooktop shall be protected.

##### **601.9 Accessible Walk-In Pantries.**

Lighting shall be installed in walk-in pantries.

**601 OPTIONS.**

*(See Sections 901 Flooring Options, 1001 Window Options, 1101 Lighting Options, 1201 Lighting Controls Options and 1401 Technology Options.)*

**601 Opt. 1 Galley Kitchen Width 60" Clearance.**

The clearance between all opposing base cabinets, countertops, appliances or walls is at least 60".

**601 Opt. 2 Pull-Down Shelves.**

Pull-down shelf accessories are installed on one or more overhead cabinets. (See Appendix A: 601 Opt. 2, p. 70.)

**601 Opt. 3 Glide-Out Shelves/Drawers and Swing-Up Shelves.**

Glide-out shelves or drawers and/or heavy-duty, swing-up shelves are installed on at least one or more base cabinets. (See Appendix A: 601 Opt. 3, p. 70.)

**601 Opt. 4 Sink Cabinet With Retractable Doors and No Center Stile.**

Retractable doors and no center stile are on the sink cabinet. (See Appendix A: 601 Opt. 4, p. 70.)

**601 Opt. 5 Counter Space Greater Than 18".**

Greater than 18" of counter space is adjacent to all ovens and the refrigerator.

**601 Opt. 6 Pull-Out Work Surface.**

There is at least one pull-out work surface, such as a cutting board, between 28" to 32" height above the finished floor is installed. (See Appendix A: 601 Opt. 6, p. 70.)

**601 Opt. 7 Lowered Counter.**

A lowered counter dimension of 36" minimum width by 28" to 32" height above the finished floor is installed. (See Appendix A: 601 Opt. 7, p. 70.)

**601 Opt. 8 Side Mount or Sprayer Sink Faucet.**

A faucet mounted on the side of the sink, or an incorporated faucet/sprayer that pulls out from the spout, or lever faucets – either single lever or double lever is installed. (See Appendix A: 601 Opt. 8, p. 70.)

**601 Opt. 9 Sink Drain in Back.**

The sink drain shall be installed in the back. (See Appendix A: 601 Opt. 9, p. 71.)

**601 Opt. 10 Cook Sink.**

A cook sink is installed. (See Appendix A: 601 Opt. 10, p. 71.)

**601 Opt. 11 Adjustable-Height Sink.**

An adjustable sink is installed.

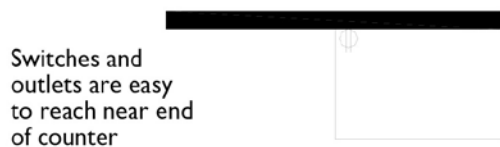

FIG. 601 OPT. 26 SWITCHES AND OUTLETS OVER COUNTERS ON BACK WALL

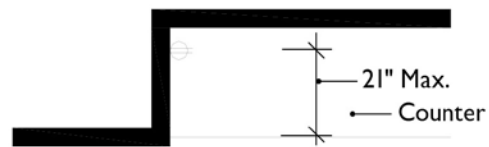

FIG. 601 OPT. 27 SWITCHES AND OUTLETS OVER COUNTERS ON BACK WALL

**601 Opt. 12 Knee Space Under Sink.**

A 27" height knee clearance is provided below the sink.

**601 Opt. 13 Dishwasher Location.**

A dishwasher is adjacent at the left or right of the sink. (See Appendix A: 601 Opt. 13, p. 71.)

**601 Opt. 14 Dishwasher Drawer or Elevated Dishwasher.**

A drawer style dishwasher or elevated dishwasher is installed. (See Appendix A: 601 Opt. 14, p. 71.)

**601 Opt. 15 Scald Guard.**

A scald guard valve or mixing valves are installed. (See Appendix A: 601 Opt. 15, p. 71.)

**601 Opt. 16 Wall Mount Oven With Side Opening Door.**

One or more wall mount ovens that have side-opening doors are installed; the door latch side is next to an 18" minimum width countertop.

**601 Opt. 17 Induction Stove.**

An induction stove is installed. (See Appendix A: 601 Opt. 17, p. 71.)

**601 Opt. 18 Stove Controls on Front or Side.**

The location of stove controls does not require reaching across burners.

**601 Opt. 19 Oven Controls on Front or Side.**

Ovens have controls on front panels or on either side of the door. (See Appendix A: 601 Opt. 19, p. 71.)

**601 Opt. 20 Roll-Under Range.**

A roll-under range is installed.

**601 Opt. 21 Microwave Oven.**

A freestanding microwave oven is placed on the counter or built-in so that the floor of the microwave is at counter top height or lower. (See Appendix A: 601 Opt. 21, p. 72.)

**601 Opt. 22 Microwave Oven Drawer.**

A microwave drawer is installed. (See Appendix A: 601 Opt. 22, p. 72.)

**601 Opt. 23 Side by Side Refrigerator or Freezer on Bottom.**

A side by side refrigerator – freezer or a refrigerator with a freezer on the bottom is installed. (See Appendix A: 601 Opt. 23, p. 72.)

**601 Opt. 24 Rounded or Contrasting Counter Edges.**

The counter corner edges are rounded or have a contrasting color edge. (See Appendix A: 601 Opt. 24, p. 72.)

**601 Opt. 25 Built-In Task Lighting.**

(See Section 1101 Opt. 2.)

**601 Opt. 26 Switches and Outlets Over Counters on Back Wall.**

Switches and outlets are easy to reach near the end of the counter and/or are placed at the front edge of base cabinets. (See Fig. 601 Opt. 26 and Appendix A: 601 Opt. 26, p. 72.)

**601 Opt. 27 Switches and Outlets Over Counters on Side Wall.**

Switches and outlets are no more than 21" from the front counter edge on a side wall. (See Fig. 601 Opt. 27 on page 24.)

**601 Opt. 28 Island Switches and Outlets.**

Switches and outlets are easy to reach on islands.

**601 Opt. 29 Touch Latch Hardware.**

Touch latch hardware is installed. (See Appendix A: 601 Opt. 29, p. 72.)



## Chapter 7. Laundry Room

### 701 Laundry Room

#### 701.1 Location.

The laundry area shall be on an accessible route. (See Appendix A: 701 General Information and 701.1, p. 73.)

#### 701.2 Clear Floor Space.

A 48" x 48" minimum clear floor space shall be provided at the washing machine, clothes dryer and laundry tub. Clear floor spaces may overlap. If there is a swing door or other type of door, it may overlap the appliance clear floor space. (See Fig. 701.2.)

#### 701.3 Turning Space.

If the laundry appliances are located in a room a 5' diameter turning space is provided, which may overlap the 48" x 48" clear floor space in front of the washer, dryer and laundry sink/tub. (See Fig. 701.2 and Appendix A: 701.2, p. 73.)

#### 701.4 Doors.

Doors shall comply with Section 201.

#### 701 OPTIONS.

(See Sections 901 Flooring Options, 1001 Window Options, 1101 Lighting Options, and 1201 Lighting Controls Options.)

##### 701 Opt. 1 Main Floor Location.

The laundry area is located on the main floor on an accessible route.

##### 701. Opt. 2 5' Diameter Turning Space.

The laundry room has a 5' diameter turning space which may overlap the 48" x 48" clear floor space in front of the washer, dryer and laundry sink/tub. (See Fig. 701.2 and Appendix A: 701 Opt. 2, p. 73.)

##### 701 Opt. 3 Front Loading Washer and Dryer.

A front loading washing machine and dryer are installed. (See Appendix A: 701 Opt. 3, p. 73.)

##### 701 Opt. 4 Front Appliance Controls.

The controls are on the front of the washing machine and dryer. (See Appendix A: 701 Opt. 4, p. 73.)

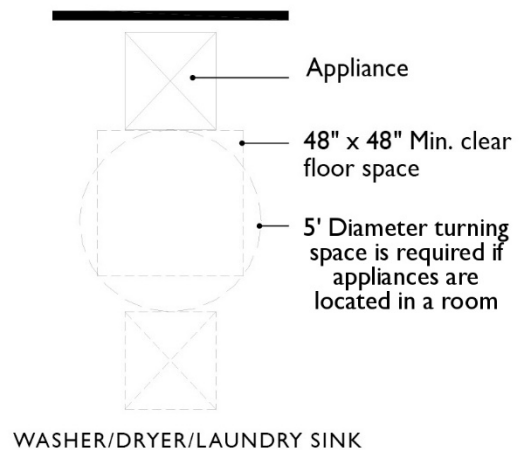

FIG. 701.2 LAUNDRY ROOM CLEAR FLOOR SPACE AND TURNING CIRCLE

**701 Opt. 5 Raised Appliances.**

A front loading washing machine and dryer are installed on a platform per client specifications. (See Appendix A: 701 Opt. 5, p. 73.)

**701 Opt. 6 Easy Reach Operable Parts.**

Operable parts, including doors, lint screens, detergent and bleach compartments are within easy reach – near the front or along the side of the appliance. (See Appendix A: 701 Opt. 6, p. 73.)

**701 Opt. 7 Built-In Task lighting.**

(See Section 1101 Opt. 2.)

## Chapter 8. Living Room

### 801 Living Room

#### **801.1 Location.**

There shall be at least one living/family room on the main floor, on an accessible route.

#### **801.2 Turning Space.**

There shall be a 5' diameter turning space.

#### **801.3 Changes in Level.**

Shall comply with Section 104.3. (See Appendix A: 801.3, p. 73.)

#### **801.4 Doors.**

Doors shall comply with Section 201.

#### **801.5 Flooring.**

Shall comply with Section 901.

#### **801 OPTIONS.**

*(See Sections 901 Flooring Options, 1001 Window Options, 1101 Lighting Options, 1201 Lighting Controls Options and 1401 Technology Options.)*

## Chapter 9. Flooring

### 901 Flooring

#### **901.1 Changes in Level.**

Shall comply with Section 104.3. (See Appendix A: 901 General Information, p. 73.)

#### **901.2 Floor Registers.**

Shall comply with Section 901.1 or shall be flush with the floor.

#### **901 OPTIONS.**

*(See Appendix – Notes 901 General Information.)*

##### **901 Opt. 1 Hard Surface Flooring.**

Hard surface flooring (tile, wood or linoleum) and/or non slip flooring (slip resistant or non-glazed ceramic tiles or linoleum products) are installed in some accessible areas of the home.

##### **901 Opt. 2 Low Pile Carpet.**

Low pile, low-level loop or commercial grade carpet is installed with either no padding or with thin, firm padding. (See Appendix A: 901 Opt. 2, p. 74.)

##### **901 Opt. 3 Slip Prevention Paint or Traction Strips.**

Traction paint or adhesive traction strips are used to prevent slipping in areas that might get wet (e.g. bathtub, garage floor and/or steps). (See Appendix A: 901 Opt. 3, p. 74.)

##### **901 Opt. 4 Color Contrast.**

A contrasting color border is installed. (See Appendix A: 901 Opt. 4, p. 75.)

## Chapter 10. Windows

### 1001 Windows

#### **1001 OPTIONS.**

*(See Appendix – Notes 1001 General Information.)*

##### **1001 Opt. 1 Operable Components.**

Operable components are a minimum of 20" to a maximum of 44" above the finished floor. (See Appendix A: 1001 General Information and Opt. 1, p. 75.)

##### **1001 Opt. 2 Window Hardware.**

Window hardware does not require fine fingering, grasping, turning or twisting, such as a casement crank or two ample size handles on a double hung window. (See Appendix A: 1001 Opt. 2, p. 75.)

##### **1001 Opt. 3 Automatic Window Openers.**

Automatic window openers are installed on some or all windows, particularly those difficult to reach.

##### **1001 Opt. 4 Automated Window Coverings.**

Automated window coverings are installed on some or all windows, particularly those difficult to reach. (See Appendix A: 1001 Opt. 4, p. 19.)

##### **1001 Opt. 5 Extended Window Covering Controls.**

Extended window covering controls, such as the plastic "wand" for mini-blinds or an extended length of cord for draperies and curtains, are installed on some or all windows, particularly those difficult to reach.

## Chapter 11. Lighting

### 1101 Lighting

#### **1101.1 Exterior Lighting.**

Exterior lighting shall be provided near all entrances so things such as the front door, porch, keyhole, keypad and house number are clearly visible. (See Section 105 Opt. 2., Fig. 105 and Appendix A: 1101 General Information, p. 76.)

#### **1101 OPTIONS.**

##### **1101 Opt. 1 Exterior Lighting.**

Outdoor lighting is installed along walks and pathways, decks, balconies, and auxiliary buildings. (See Appendix A: 1101 Opt. 1, p. 76.)

##### **1101 Opt. 2 Built-In Task Lighting.**

Built-in task lighting is provided at areas such as under kitchen cabinets, kitchen desks or islands, laundry room cabinets, hobby or office work surfaces. (See Appendix A: 1101 Opt. 2, p. 77.)

##### **1101 Opt. 3 Remote Controls.**

Remote controls for ceiling fans/lights are installed.

##### **1101 Opt. 4 Lighted Door Bells.**

Lighted door bells are installed.

## Chapter 12. Lighting Controls, Electrical Switches, and Outlets

### 1201 Lighting Controls, Electrical Switches, and Outlets

#### **1201.1 Electrical Panel Box.**

The electrical panel box shall be on an accessible route. (See Appendix A: 1201.1, p. 77.)

#### **1201.2 Electrical Panel Box Clear Floor Space.**

A clear 32" x 48" floor space shall be provided at the electrical panel box for either a parallel or perpendicular approach.

#### **1201.3 Door.**

Any door or doorway directly opening into the electrical panel box location shall be 36" wide in accordance with Section 201.

#### **1201.4 Electrical Panel Box Upper Fuse Height.**

The upper most circuit breaker switch is a maximum of 54" above the finished floor.

### **1201 OPTIONS.**

#### **1201 Opt. 1 Electrical Panel Box Location.**

Electrical panel box is located on the main floor or in the garage.

#### **1201 Opt. 2 Outlets 18"–24" High.**

Typical electrical outlets are 18"–24" on center above the finished floor. (See Appendix A: 1201 Opt. 2, p. 77.)

**EXCEPTION:** Floor outlets, outlets above the counter, TV monitor outlets and similar non-typical or specialized electrical outlets need not adhere to the 18"–24" maximum height.

#### **1201 Opt. 3 48" Max. Switch Heights.**

Electrical switches are a maximum of 48" on center above the finished floor; 44" is preferred height. (See Appendix A: 1201 Opt. 3, p. 77.)

#### **1201 Opt. 4 Rocker Switches.**

Rocker switches or lighted rocker switches are installed. (See Appendix A: 1201 Opt. 4, p. 77.)

#### **1201 Opt. 5 Dimmer Switches.**

Dimmer switches that have large controls, e.g. a dial or large lever, or are lighted, are installed.

#### **1201 Opt. 6 Three or Four-Way Switches.**

Three or four-way switches are installed so lights can be activated from several locations.

#### **1201 Opt. 7 Programmable Lighting.**

Programmable lighting is installed.

**1201 Opt. 8 Motion Activated Lights or Motion Detectors.**

Occupancy sensor lights/motion detectors are installed in places such as entrances, garages, basements and utility spaces. (See Appendix A: 1201 Opt. 8, p. 77.)



## Chapter 13. Heating, Ventilation and Air Conditioning

### 1301 Heating, Ventilation and Air Conditioning (HVAC)

#### **1301.1 Thermostat.**

The thermostat shall be on an accessible route, according to Section 101. (See Appendix A: 1301 General Information, p. 78.)

#### **1301.2 Thermostat Clear Floor Space.**

A clear 32" x 48" minimum clear floor space shall be provided at the thermostat for either a parallel or perpendicular approach.

#### **1301 OPTIONS.**

##### **1301 Opt. 1 Furnace on Main Floor.**

The furnace is installed on an accessible route on the main floor. (See Appendix A: 1301 Opt. 1, p. 78.)

##### **1301 Opt. 2 Furnace Clear Floor Space.**

A 32" x 48" clear floor space at the front of the furnace is provided. (See Appendix A: 1301 Opt. 2, p. 78.)

##### **1301 Opt. 3 54" Maximum Thermostat Height.**

The thermostat is located at 54" maximum height above the finished floor. (See Appendix A: 1301 Opt. 3, p. 78.)

##### **1301 Opt. 4 Programmable Thermostat.**

A programmable thermostat is installed. (See Appendix A: 1301 Opt. 4, p. 78.)

##### **1301 Opt. 5 Easy To Read Thermostat.**

An easy to read thermostat is installed that is back lit (glow in the dark) with very large numbers showing the heating set point, the cooling set point and the room temperature.

##### **1301 Opt. 6 Remote Controls.**

Remote controls for heating and/or cooling systems are installed. (See Appendix A: 1301 Opt. 6, p. 79.)

##### **1301 Opt. 7 Furnace Filter.**

Ability to reach and change filter is easy.

##### **1301 Opt. 8 Air Conditioning.**

Air conditioning is installed.

## Chapter 14. Technology and Automation In The Home

### 1401 Technology and Automation In The Home

#### **1401 OPTIONS.**

*(See Appendix – Notes 1401 General Information.)*

#### **1401 Opt. 1 Remote Control Smoke Detectors.**

The home has a UL rated, infrared, remote control feature smoke detector installed.

#### **1401 Opt. 2 Smoke Detectors Linked to a Security Systems Provider.**

The smoke detectors are linked to a security systems provider or a rapid response system in case of a fire.

#### **1401 Opt. 3 Visible and Audible Alarms.**

In addition to a sound alarm, a UL rated smoke, fire or carbon monoxide detector is equipped with either a strobe or flashing light. (See Appendix A: 1401 Opt. 3, p. 79.)

#### **1401 Opt. 4 Gas Detector(s).**

At least one hardwired, battery-operated or plug-in type carbon monoxide (CO) detector is installed.

#### **1401 Opt. 5 Fire Extinguishers.**

A fire extinguisher is provided on each floor in accessible locations. Preferred locations are the kitchen, bedrooms, garage and basement.

#### **1401 Opt. 6 Security/Surveillance System.**

Security/surveillance system is installed. (See Appendix A: 1401 Opt. 6, p. 79.)

#### **1401 Opt. 7 Remote Deadbolt Locks.**

Remote electrical deadbolt locks are installed on exterior doors.

#### **1401 Opt. 8 Intercom System.**

Keypad intercoms or video intercom systems are installed between 42"–48" above the finished floor. (See Appendix A: 1401 Opt. 8, p. 79.)

#### **1401 Opt. 9 Voice Control System.**

A voice control system is installed. Examples of voice control systems include: lights, devices, appliances, home theater, audio/video, security, climate, telephone and the Internet are installed.

#### **1401 Opt. 10 T-Loop Transmitter System.**

T-loop wireless hearing aid transmitter system is installed.

#### **1401 Opt. 11 Environmental Control Unit.**

An Environmental Control Unit (ECU) system is installed, such as a hard-wired system, system based on X-10 or infrared computer control modules.

**1401 Opt. 12 Programmable HVAC System.**

A programmable heating/cooling system is installed.

**1401 Opt. 13 Home Air Purifier.**

A home air purifier is installed.

**1401 Opt. 14 Central Vacuum.**

A central vacuum system is installed.

**1401 Opt. 15 Wall-Mount Phones.**

One or more wall-mount phones are installed between 42"–48" high at the top of the unit.

**1401 Opt. 16 Home Network System.**

A home network system receives phone, internet, cable or satellite TV lines, as well as stereo and video connections from an entertainment center in the home.

**1401 Opt. 17 Internet Connections.**

An Internet connection (voice/data) is installed throughout the home. (See Appendix A: 1401 Opt. 17, p. 79.)

**1401 Opt. 18 Wireless Internet.**

A wireless Internet system is installed throughout the home.

# ZeroStep Checklist



<b>102 Parking and Driveways</b>	<b>NA</b>	<b>NO</b>	<b>YES</b>
<p><b>102.1 Parking and driveways</b></p> <p>There is one accessible parking space on an accessible route to a zero-step entrance. The accessible parking area is 1:48 (2%) in all directions. The accessible driveway portion has a maximum cross slope of 1:48 (2%) and a maximum running slope of 1:20 (5%).</p>			
NA Justification:			
<b>102 OPTIONS</b>			<b>PTS</b>
<p><b>102 Opt. 1 16' Minimum Width By 8' Minimum Length Loading/Unloading Zone.</b></p> <p>There is at least a 16' wide by 8' minimum length loading/unloading zone with an accessible route to the home.</p>			<b>1</b>
<p><b>102 Opt. 2 Surface Materials.</b></p> <p>The driveway is covered with a firm surface material.</p>			<b>2</b>
<p><b>102 Opt. 3 24' Minimum Level Parking Space.</b></p> <p>A minimum length of 24' of the driveway has a slope and cross slope of 1:48 (2%).</p>			<b>2</b>
<b>Total Points</b>			

<b>103 Garage</b>	<b>NA</b>	<b>NO</b>	<b>YES</b>
<p><b>103.1 Garage Minimum Measurements – One Stall.</b></p> <p>A one stall garage has a minimum of 16' clear width, 24' minimum depth. There is a minimum of a 5' width access aisle located on an accessible route into the home. There is a minimum of a 3' width access aisle on the opposite side of the vehicle.</p>			
<p><b>103.2 Garage Minimum Measurements – Two Stall.</b></p> <p>A two stall garage has a minimum of 27' clear width, 24' minimum depth. There is a minimum of a 5' width access aisle located on an accessible route into the home. There is a minimum of a 3' width access aisle on the opposite side of the vehicle.</p>			
NA Justification:			

<b>103 OPTIONS</b>		<b>PTS</b>
<b>103 Opt. 1 Slope Entire Garage Floor.</b> The entire garage floor is sloped so that the entrance door into the home is accessed from the 5' wide access aisle and there is no greater than a ½" high, beveled threshold.		<b>3</b>
<b>103 Opt. 2 Garage Ramp.</b> A ramp to the home entrance is installed in the garage with a slope no greater than 1:12 (8%).		<b>2</b>
<b>103 Opt. 3 9' Minimum Garage Door Height.</b> Is installed.		<b>2</b>
<b>103 Opt. 4 Electric Garage Door Opener.</b> Is installed.		<b>3</b>
<b>103 Opt. 5 Automatic Lighting.</b> Is installed.		<b>1</b>
<b>103 Opt. 6 Door Swing.</b> Doors do not swing into the accessible route.		<b>3</b>
<b>Total Points</b>		

<b>104 Walks and Pathways</b>	<b>NA</b>	<b>NO</b>	<b>YES</b>
<b>104.1 Slope.</b> Is not steeper than 1:20 (5%).			
<b>104.2 Cross Slope.</b> Is maximum of 1:48 (2%).			
<b>104.3 Changes in Level.</b>			
<b>104.3.1</b> Changes in level greater than ½" are beveled.			
<b>104.3.2</b> Changes in level between ¼" high and ½" high are beveled 1:2.			
<b>104.3.3</b> Changes in level up to ¼" high can remain vertical.			
<b>104.4 Clear Width.</b> Is a minimum of 36" wide.			
NA Justification:			

<b>104 OPTIONS</b>		<b>PTS</b>
<b>104 Opt. 1 Additional Walks or Pathways.</b> Two zero-step entrances are installed and are not steeper than 1:20 (5%).		<b>1</b>
<b>104 Opt. 2 Width Greater than 36".</b> Is installed.		<b>2</b>
<b>104 Opt. 3 Firm, Stable, Non-Slip Surface Materials.</b> Are installed.		<b>2</b>
<b>104 Opt. 4 Sheltered Walkway.</b> Between the vehicle and the home is installed.		<b>2</b>
<b>104 Opt. 5 Lighting.</b> Is installed.		<b>2</b>
<b>Total Points</b>		

<b>105 Porches, Patios, Decks and Landings</b>	<b>NA</b>	<b>NO</b>	<b>YES</b>
<b>105.1 Location.</b> On the primary accessible entrance to the home complies with Section 201.2, 201.3 and 1101.1.			
<b>105.2 Turning Space.</b> The porch has a 5' diameter turning space and is in front of the primary door opening.			
<b>105.3 Changes in Level.</b> Comply with <u>Section 104 Walks and Pathways, 104.3.1–104.3.3.</u>			
<b>105.4 Openings.</b> Deck boards are spaced no more than ¼" apart.			
NA Justification:			

<b>105 OPTIONS</b>		<b>PTS</b>
<b>105 Opt. 1 Shelf.</b> Is located on the strike side of an accessible door.		<b>1</b>
<b>105 Opt. 2 Address Numbers.</b> Are a minimum of 4" high, high contrast or reflective material or lighted, and located in a prominent place on the house and/or the mailbox.		<b>1</b>

<b>105 OPTIONS, continued</b>		<b>PTS</b>
<b>105 Opt. 3 Primary Covered Entry.</b> A 5' x 5' minimum covered entry is provided at the primary zero-step entrance.		<b>2</b>
<b>105 Opt. 4 All Covered Entries.</b> A covered entry is provided at all zero-step entries.		<b>3</b>
<b>105 Opt. 5 Door Bells.</b> Installed at more than one entrance.		<b>1</b>
<b>Total Points</b>		

<b>106 Ramps</b>	<b>NA</b>	<b>NO</b>	<b>YES</b>
<b>106.1 When to Install a Ramp.</b> When the walking slope is greater than 1:20 (5%).			
<b>106.2 Slope.</b> Is not steeper than 1:12 (8%).			
<b>106.3 Cross Slope.</b> Is a maximum of 1:48 (2%).			
<b>106.4 Clear Width.</b> (Of a ramp run) is a minimum width of 42" to a maximum of 48". Code allows a clear ramp width of 36" but this should be used in rare circumstances.			
<b>106.5 Rise.</b> Is 30" maximum between landings and preferably less.			
<b>106.6 Landings.</b> Are at the bottom and top of each ramp run, and the run does not exceed 30' (preferably 24') between landings.			
<b>106.6.1 Landing Slope.</b> Is 1:48 (2%) or less.			
<b>106.6.2 Landing Clear Width.</b> Is at least as wide as the widest ramp run leading to the landing.			
<b>106.6.3 Landing Length.</b> Is 60" minimum.			
<b>106.6.4 Change in Direction - 90° Turn.</b> Has a minimum 5' x 5' landing.			

<b>106 Ramps, continued</b>	<b>NA</b>	<b>NO</b>	<b>YES</b>
<p><b>106.6.5 Landing Change in Direction - 180° Turn.</b></p> <p>Has a minimum 7' length which is equal to the sum of the ramp widths plus space between ramps, if any, by 5' landing width.</p>			
<p><b>106.6.6 Landings for a Child.</b></p> <p>A home owner has customized the landing if applicable.</p>			
<p><b>106.7 Edge Protection.</b></p> <p>Complies with <u>Section 1010.9.1 or 1010.9.2 of the Michigan Building Code.</u></p>			
<p><b>106.8 Handrails.</b></p> <p>Ramps with a rise greater than 6" have graspable handrails. Handrail height is not less than 34" and not more than 36".</p>			
<p><b>106.8.1 Handrail Location.</b></p> <p>Handrails are provided on both sides of ramp.</p> <p><u>EXCEPTION:</u> Ramps that are parallel and attached to the home or garage may have one continuous handrail on the side opposite the home or garage.</p>			
<p><b>106.8.2 Handrail Continuity.</b></p> <p>Are continuous.</p>			
<p><b>106.8.3 Balusters.</b></p> <p>The space between balusters does not exceed 4".</p>			
<p><b>106.9 Handrail Clearance and Graspability.</b></p> <p>The handrail clearance shall be 1 ½" minimum from an adjacent surface. Handrails with a circular cross section shall have a perimeter dimension of 4" minimum and 6 ¼" maximum, and a cross-section dimension of 2 ¼" maximum.</p>			
<p><b>106.10 Outdoor Conditions.</b></p> <p>Outdoor ramps and outdoor approaches to ramps are designed so that water will not accumulate on walking surfaces.</p>			
<p><b>106.11 Ramp Surface.</b></p> <p>Is of slip-resistant materials that are securely attached, or a brushed concrete surface.</p>			
NA Justification:			
<b>106 OPTIONS</b>			<b>PTS</b>
<b>106 Opt. 1 No Ramp Required.</b>			<b>3</b>



<b>106 OPTIONS, continued</b>	<b>PTS</b>
<b>106 Opt. 2 Second Graspable Handrail.</b> Is installed.	<b>2</b>
<b>106 Opt. 3 Slope Less Than 1:12 (8%)</b>	<b>3</b>
<b>106 Opt. 4 Ramp Run 24' or Less.</b> A ramp run of 24' or less is installed, while adhering to Guideline 106.2 requiring the ramp slope not be steeper than 1:12 (8%).	<b>3</b>
<b>Total Points</b>	

<b>201 Doors and Doorways</b>	<b>NA</b>	<b>NO</b>	<b>YES</b>
<b>201.1 Zero-step Exterior Entrance.</b> There two or more zero-step exterior entrances on an accessible route to the home that complies with <u>Section 104.3 and 1101.1.</u>			
<b>201.2 Clear Width.</b> Doors and doorways that are on an accessible route shall have a clear opening width of 34" minimum which is typically accomplished by a 36" wide door.			
<b>201.3 18" Minimum Maneuvering Clearances</b> Are on push and pull, latch side of door.			
<b>201.4 Swinging Doors, Sliding and Folding Doors, Doorways Without Doors and Pocket Doors.</b> That are on an accessible route have a clear opening width of 34" minimum.			
<b>201.5 Changes in Level.</b> Doors and doorways that are on an accessible route comply with <u>Section 104.3.1 – Section 104.3.3.</u>			
<b>201.6 Split Level Landing.</b> No split level landings are at zero-step entrances in the home.			
<b>201.7 Two Doors In Series.</b> Minimum maneuvering clearances shall be at double doors on an accessible route. Door swings shall not infringe on the 5' turning space.			
NA Justification:			

<b>201 OPTIONS</b>		<b>PTS</b>
<b>201 Opt. 1 Sidelite.</b> Either one or two sidelites are provided by the primary entrance door.		<b>2</b>
<b>201 Opt. 2 Lever Door Hardware.</b> Is used on all doors of dwelling.		<b>2</b>
<b>201 Opt. 3 Automatic Door Opener.</b> Is installed on an accessible door.		<b>3</b>
<b>Total Points</b>		

<b>202 Hallways</b>	<b>NA</b>	<b>NO</b>	<b>YES</b>
<b>202.1 Width.</b> An accessible route through a hallway shall be 42" minimum clear width. 42" hallways are required on an accessible route.			
<b>202.2 Changes in Level.</b> Comply with <u>Section 104.3.1 – Section 104.3.3.</u>			
NA Justification:			

<b>202 OPTIONS</b>		<b>PTS</b>
<b>202 Opt. 1 Width Greater than 42".</b> Is provided.		<b>2</b>
<b>Total Points</b>		

<b>203 Stairways</b>	<b>NA</b>	<b>NO</b>	<b>YES</b>
<b>203.1 Interior Landing At Exterior Doorway.</b> Comply with <u>Section 201.4.</u>			
<b>203.2 Stairway Lighting.</b> Is provided at all interior and exterior stairways with a means to illuminate the stairs, landings and treads. Interior stairways have an artificial light source located in the immediate vicinity of each landing of the stairway.			

<b>203 Stairways, continued</b>	<b>NA</b>	<b>NO</b>	<b>YES</b>
<p><b>203.3 Lighting Controls.</b></p> <p>Are accessible at the top and bottom of each stairway without traversing any steps. The illumination of exterior stairways is controlled from inside the dwelling unit.</p>			
NA Justification:			
<b>203 OPTIONS</b>			<b>PTS</b>
<p><b>203 Opt. 1 No Open Risers.</b></p> <p>Are installed.</p>			<b>2</b>
<p><b>203 Opt. 2 Increased Width.</b></p> <p>Is 42" wide to 48" wide.</p>			<b>2</b>
<p><b>203 Opt. 3 Deeper Treads &amp; Lower Risers.</b></p> <p>Are installed.</p>			<b>3</b>
<p><b>203 Opt. 4 Landings or Clear Floor Space Exceed Minimums.</b></p> <p>Of a minimum 36" wide by a minimum 42" in the direction of travel.</p>			<b>3</b>
<p><b>203 Opt. 5 Two Handrails.</b></p> <p>Handrails are installed on both sides of stairway.</p>			<b>2</b>
<p><b>203 Opt. 6 Handrail Extension.</b></p> <p>At the top and bottom of a stair flight, handrail(s) extend beyond the landing 12 inches.</p>			<b>2</b>
<p><b>203 Opt. 7 Handrail Terminations.</b></p> <p>At the top and bottom of a stair flight, the handrail ends are returned to the floor, wall or post.</p>			<b>2</b>
<p><b>203 Opt. 8 Wall Reinforcement for Additional Custom Height Handrail.</b></p> <p>Wood 2x blocking is installed for custom height handrail.</p>			<b>3</b>
<p><b>203 Opt. 9 Lighting Along Length.</b></p> <p>Is installed.</p>			<b>3</b>
<p><b>203 Opt 10 Electrical Outlets.</b></p> <p>Are in place for future stair-lift or incline platform lift.</p>			<b>2</b>
<p><b>203 Opt. 11 Stair-Lift or Incline Platform-Lift Installed.</b></p> <p>Is installed.</p>			<b>3</b>
<b>Total Points</b>			

<b>204 Elevators OPTIONS</b>		<b>PTS</b>
<b>204 Opt. 1 Stacked Walk-In Closets.</b> A 5' x 5' clear interior dimension for “stacked” walk-in closets for a future elevator is constructed.		<b>3</b>
<b>204 Opt. 2 Elevator Installed.</b>		<b>3</b>
<b>Total Points</b>		

<b>205 Balconies, Lofts, Raised or Sunken Areas</b>	<b>NA</b>	<b>NO</b>	<b>YES</b>
<b>205.1 Balconies, Lofts, Raised or Sunken Areas and Split-Level Entries.</b> Do not interfere with the accessible route or with the accessible bathroom, kitchen and living room.			
NA Justification:			

<b>205 OPTIONS</b>		<b>PTS</b>
<b>205 Opt. 1 No Balconies, Lofts, Raised or Sunken Areas.</b> Are installed.		<b>3</b>
<b>Total Points</b>		

<b>301 Bathrooms</b>	<b>NA</b>	<b>NO</b>	<b>YES</b>
<b>301.1 Location.</b> There is at least one full size bathroom (consisting of a sink, toilet, and bathtub or shower) on the main floor, on an accessible route,			
<b>301.2 Turning Space.</b> There is a 5' diameter turning space.			
<b>301.3 Clear Floor Space.</b> A 48" x 48" minimum clear floor space is provided at the sink, bathtub and shower. Only 19" of the 48" clear floor space extends under the sink. The 48" x 48" clear floor spaces may overlap and include the toe kick space. (See Reference Illustration 301.3 and Appendix–Notes 301.3)  <u>EXCEPTION:</u> Where a 48" x 48" clear floor space cannot be provided, a 32" x 48" minimum clear floor space is permitted with two provisions: the 32" x 48" clear floor space is positioned parallel to the fixtures and provide sufficient floor space to enlarge to a 48" x 48" clear floor space without moving perimeter bathroom walls. This requires changing fixtures or cabinetry.			

301 Bathrooms, continued	NA	NO	YES
<p><b>301.4 Toilet Clear Floor Space.</b></p> <p>A clear floor space around the toilet of 48" minimum, measured perpendicular from the side wall, and 66" minimum, measured perpendicular from the rear wall, is provided. The required clearance around the toilet is permitted to overlap other fixture clear floor spaces.</p> <p><b>EXCEPTION:</b> Where a clear 48" x 66" clear floor space cannot be provided, a 32" x 48" minimum clear floor space is permitted with two provisions: the 32" x 48" clear floor space is positioned <u>parallel</u> to the front of the toilet rim <u>and</u> provide sufficient floor space to enlarge to a 48" x 66" clear floor space without moving perimeter bathroom walls. This requires changing fixtures or cabinetry.</p>			
<p><b>301.5 Doors.</b></p> <p>Comply with <u>Section 201.</u></p>			
<p><b>301.6 Wall Reinforcement.</b></p> <p>Walls are reinforced with 2x blocking concealed in the wall around toilets, bathtubs, showers and for slide bar, hand held showers. Allowable stresses do not exceed for materials used where a vertical or horizontal force of 250 pounds is applied.</p>			
<p><b>301.7 Wall Reinforcement Documentation.</b></p> <p>Wall reinforcement documentation for installation of future grab bars is provided.</p>			
<p><b>301.8 Bathtub/Shower Stall 12" Deep</b></p> <p><b>Clear Floor Space.</b></p> <p>A 12" minimum clear floor space is provided along the entire <u>length</u> of a bathtub and/or a shower stall according to <u>Table 301.10.</u></p>			
<p><b>301.9 Bathtub Height.</b></p> <p>On-slab construction does not increase the height of the bathtub.</p>			
<p><b>301.10 Toilet.</b></p> <p>Is positioned with a wall to the rear and a wall to one side. The centerline of the toilet is 18" on center from the side wall. If the toilet cannot be positioned against a wall to one side, the rear wall has wall reinforcement with blocking for future pull down grab bar placement.</p>			

<b>301 Bathrooms, continued</b>	<b>NA</b>	<b>NO</b>	<b>YES</b>
<b>301.11 Shower Stall.</b> A minimum shower stall is 36" x 36". Shower stalls must comply with Shower Stall Approaches <u>Table 301.10.</u>			
<b>301.12 Sink Cabinet.</b> A minimum of a 36" wide cabinet shall be permitted under the bathroom sink, provided the counter top is self supportive and the base cabinet under the sink is in-filled. A cabinet without a center stile is recommended.			
<b>301.13 Exposed Pipes.</b> Where knee space is provided under sinks, exposed pipes and surfaces are insulated or configured to protect against contact.			
NA Justification:			
<b>301 OPTIONS</b>			<b>PTS</b>
<b>301 Opt. 1 Accessible Half-Bath – Main Floor.</b> Is provided.			<b>3</b>
<b>301 Opt. 2 2nd Accessible Full-Size Bath – Main Floor.</b> Is provided.			<b>3</b>
<b>301 Opt. 3 Accessible Half-Bath/Full Bath – Second Floor.</b> Is provided.			<b>3</b>
<b>301 Opt. 4 No Doors Swing Into 5' Turning Space.</b>			<b>3</b>
<b>301 Opt. 5 Bathroom Doors Swing Out.</b>			<b>3</b>
<b>301 Opt. 6 Wall Reinforcement Extended.</b> Is extended beyond <u>Section 301.6</u> requirements and/or includes wood blocking for future child-height grab bars.			<b>3</b>
<b>301 Opt. 7 Wall Reinforcement Document Permanent Installation.</b> Is installed in the bathroom.			<b>3</b>
<b>301 Opt. 8 Grab Bars Installed.</b>			<b>3</b>
<b>301 Opt. 9 Comfort Height Toilet.</b> With a rim between 17" and 19" high, above the floor is installed.			<b>2</b>
<b>301 Opt. 10 Bidet or Toilet Seat with Bidet Functionality.</b> Is installed.			<b>2</b>
<b>301 Opt. 11 Mirror Mounting Height.</b> Mirrors above sinks are mounted with the bottom edge of the reflecting surface no higher than 40" above the finished floor.			<b>1</b>

<b>301 OPTIONS, continued</b>	<b>PTS</b>
<p><b>301 Opt. 12 Mirror Types.</b></p> <p>Full length mirrors, tilt mirrors, mirrors that turn, split-angle mirrors, or magnifying mirrors are installed.</p>	<b>1</b>
<p><b>301 Opt. 13 Shut-off Valves.</b></p> <p>Are easily reached from a seated position.</p>	<b>2</b>
<p><b>301 Opt. 14 Toe Clearance.</b></p> <p>A 9" high toe clearance on base cabinets is installed.</p>	<b>2</b>
<p><b>301 Opt. 15 Space Under Sink.</b></p> <p>In accessible bathrooms, wall-hung, pedestal, or exposed basin sinks (exposed sink front on a vanity) are installed with a minimum of a 27" space from above the finished floor to underneath the bowl of the sink. The drain is placed toward the back of the fixture rather than the middle.</p>	<b>3</b>
<p><b>301 Opt. 16 Sink Height Between 32"–34".</b></p>	<b>3</b>
<p><b>301 Opt. 17 Levers or Handle on Faucet Control.</b></p> <p>Dual or single levers or handle are installed.</p>	<b>3</b>
<p><b>301 Opt. 18 Sink Faucet Location.</b></p> <p>Is mounted on the side of the sink, rather than at the back.</p>	<b>2</b>
<p><b>301 Opt. 19 Motion Activated Faucets.</b></p> <p>Are installed.</p>	<b>3</b>
<p><b>301 Opt. 20 Scald Guard.</b></p> <p>Is installed.</p>	<b>3</b>
<p><b>301 Opt. 21 Bathtub 36" deep Clear Floor Space.</b></p> <p>Is provided along the entire length of the bathtub.</p>	<b>3</b>
<p><b>301 Opt. 22 Bathtub Height.</b></p> <p>Is 16" maximum above the floor.</p>	<b>3</b>
<p><b>301 Opt. 23 Accessible Bathtub.</b></p> <p>Is installed.</p>	<b>3</b>
<p><b>301 Opt. 24 Bathtub/Shower Faucet Control Location.</b></p> <p>Controls are repositioned closer to the bathtub or shower stall front rim/edge.</p>	<b>2</b>
<p><b>301 Opt. 25 Hand Held Shower.</b></p> <p>Is installed.</p>	<b>2</b>

<b>301 OPTIONS, continued</b>		<b>PTS</b>
<b>301 Opt. 26 Additional Shower Controls.</b> Are installed.		<b>3</b>
<b>301 Opt. 27 Acrylic Bathtub/Shower Wall Reinforcement.</b> Is installed with no dead air space between the unit and adjacent walls.		<b>3</b>
<b>301 Opt. 28 Non-Conventional Bathtubs.</b> Non-conventional bathtubs, whirlpools and saunas follow Sections 301.2, 301.3, 301.5, 301.6., 301.7, 301.8, and 301.9.		<b>3</b>
<b>301 Opt. 29 Walk-In Shower Stall.</b> A minimum of a 36" x 36" walk-in shower stall is installed.		<b>3</b>
<b>301 Opt. 30 Wet Room.</b> Is installed.		<b>3</b>
<b>301 Opt. 31 Shelving.</b> Is installed at front corner, closest to bathroom fixture controls, or on the side wall, where it doesn't interfere with fixture grab bars.		<b>2</b>
<b>301 Opt. 32 Telephone Jack.</b> A telephone jack is installed in the bathroom.		<b>3</b>
<b>301 Opt. 33 Counter/Cabinets and Outlets.</b> Are easy to reach near the end of the counter, or are placed at the front edge of base cabinets; and/or switches and outlets are no more than 21" from the front counter edge on a side wall.		<b>2</b>
<b>301 Opt. 34 Extending Flooring Under Removable Cabinets.</b> Extending a finished flooring material, such as wood, tile, or vinyl, under removable bathroom cabinets is provided.		<b>3</b>
<b>Total Points</b>		

<b>401 Bedrooms</b>	<b>NA</b>	<b>NO</b>	<b>YES</b>
<b>401.1 Location.</b> At least one bedroom is on an accessible route, on the main floor near an accessible bathroom.			
<b>401.2 Turning Space.</b> A clear 5' diameter turning space is provided.			
<b>401.3 Doors.</b> Comply with <u>Section 201</u> .			
NA Justification:			



<b>401 OPTIONS</b>		<b>PTS</b>
<b>401 Opt. 1 Additional Main Floor Accessible Bedroom.</b> Is provided.		<b>3</b>
<b>401 Opt. 2 Additional Alternate Floor Accessible Bedroom.</b> Is provided.		<b>3</b>
<b>401 Opt. 3 Emergency Escape Window Exceeds Michigan Building Code.</b> (5.7 square ft.)		<b>3</b>
<b>401 Opt. 4 Exterior Emergency Escape Door.</b> Is installed.		<b>3</b>
<b>401 Opt. 5 Additional Outlets On Bed Wall.</b> Consisting of at least two outlets (one receptacle box) on each side of the bed or more.		<b>2</b>
<b>401 Opt. 6 Bedside Switch Outlet.</b> Is installed.		<b>2</b>
<b>401 Opt. 7 Auxiliary Wiring.</b> (Telephone jacks, cable TV, Internet) is installed.		<b>2</b>
<b>Total Points</b>		

<b>501 Closets</b>	<b>NA</b>	<b>NO</b>	<b>YES</b>
<b>501.1 Location.</b> One accessible closet is in an accessible bedroom.			
<b>501.2 Clear Floor Space.</b> A 48" x 48" minimum clear floor space is in front of a wall closet.			
<b>501.3 Doors.</b> Comply with <u>Section 201</u> .			
<b>501.4 Lighting.</b> Is installed in accessible walk-in closets in accordance with Michigan Residential Code E3903.1			
NA Justification:			
<b>501 OPTIONS</b>			
<b>501 Opt. 1 Two or More Additional Accessible Closets.</b> Two or more additional accessible closets are provided on an accessible route.			<b>PTS</b>
			<b>2</b>

<b>501 OPTIONS, continued</b>		<b>PTS</b>
<b>501 Opt. 2 Overhead/Recessed Door Mounting Hardware.</b> Accessible closet door hardware is suspended from above or tracks are recessed into the floor for sliding doors.		<b>3</b>
<b>501 Opt. 3 Walk-In Closets With 5' Turning Space.</b> Walk-in closets have a 5' diameter turning space within the closet, or have a 42" minimum clear width aisle within or through the closet.		<b>3</b>
<b>501 Opt. 4 Adjustable Rods.</b> Are installed.		<b>3</b>
<b>501 Opt. 5 Shelves.</b> Between 15" and 48" high are installed.		<b>2</b>
<b>501 Opt. 6 Pull-Out Shelves or Pull Down Shelves.</b> Are installed.		<b>2</b>
<b>501 Opt. 7 Drawers.</b> Are installed.		<b>2</b>
<b>501 Opt. 8 Closet Carrousel.</b> Is installed.		<b>3</b>
<b>Total Points</b>		

<b>601 Kitchens</b>	<b>NA</b>	<b>NO</b>	<b>YES</b>
<b>601.1 Location.</b> There is at least one accessible kitchen on the main floor on an accessible route.			
<b>601.2 Doors.</b> Shall comply with <u>Section 201</u> .			
<b>601.3 Turning Space.</b> A 5' diameter turning space is provided.  <u>EXCEPTION:</u> A galley kitchen may have a minimum 48" clearance between all opposing base cabinets, countertops, appliances or walls, with a 5' diameter turning space at either end.  An island may have a minimum 48" clearance between all opposing base cabinets, countertops, appliances or walls measured beneath the counter, with a 5' diameter turning space located in the kitchen.			

<b>601 Kitchens, continued</b>	<b>NA</b>	<b>NO</b>	<b>YES</b>
<b>601.4 Clear Floor Space.</b> A 48" x 48" minimum clear floor space is provided at ranges, cooktops, ovens, wall-mount ovens, dishwashers, kitchen sinks, microwave ovens, pantry, refrigerators, and trash compactors.			
<b>601.4.1 Sink.</b> The centerline of the sink is aligned with the centerline of the approach.			
<b>601.5 Sink Cabinet.</b> A minimum 36" wide cabinet is permitted under a kitchen sink or cooktop, provided the cabinetry can be removed.			
<b>601.6 Counter Width.</b> A minimum 18" width counter space is located near all ovens and the refrigerator.			
<b>601.7 Sink Exposed Pipes and Surfaces.</b> Are reconfigured to protect against contact. There are no sharp or abrasive surfaces under sinks.			
<b>601.8 Underneath Range/Cooktop Exposed Hot Surfaces.</b> Where knee space is provided, the underside of the range or cooktop is protected.			
<b>601.9 Accessible Walk-In Pantries.</b> Lighting is installed.			
NA Justification:			
<b>601 OPTIONS</b>			<b>PTS</b>
<b>601 Opt. 1 Galley Kitchen With 60" Clearance.</b> Is provided between all opposing cabinets.			<b>3</b>
<b>601 Opt. 2 Pull-Down Shelves.</b> Are installed.			<b>3</b>
<b>601 Opt. 3 Glide-Out Shelves/Drawers &amp; Swing-Up Shelves.</b> Are installed.			<b>3</b>
<b>601 Opt. 4 Sink Cabinet With Retractable Doors AND No Center Stile.</b> Is installed.			<b>3</b>
<b>601 Opt. 5 Counter Space Greater Than 18" wide.</b> Is adjacent to all ovens and the refrigerator.			<b>2</b>

<b>601 OPTIONS, continued</b>	<b>PTS</b>
<b>601 Opt. 6 Pull-Out Work Surface.</b> Between 28" to 32" height above the finished floor is installed.	<b>3</b>
<b>601 Opt. 7 Lowered Counter.</b> A lowered counter dimension of 36" minimum width by 28" to 32" height above the finished floor is installed.	<b>3</b>
<b>601 Opt. 8 Side Mount or Sprayer Sink Faucet.</b> Is installed.	<b>2</b>
<b>601 Opt. 9 Sink Drain In Back.</b>	<b>2</b>
<b>601 Opt. 10 Cook Sink.</b> Is installed.	<b>3</b>
<b>601 Opt. 11 Adjustable-Height Sink.</b> Is installed.	<b>3</b>
<b>601 Opt. 12 Knee Space Under Sink.</b> A 27" height knee clearance is provided below the sink.	<b>3</b>
<b>601 Opt. 13 Dishwasher Location.</b> Adjacent at the left/right of the sink.	<b>3</b>
<b>601 Opt. 14 Dishwasher Drawer or Elevated Dishwasher.</b> Is installed.	<b>2</b>
<b>601 Opt. 15 Scald Guard.</b> Mixing valves are installed.	<b>3</b>
<b>601 Opt. 16 Wall Mount Oven With Side Opening Door.</b> Are installed.	<b>3</b>
<b>601 Opt. 17 Induction Stove.</b> Is installed.	<b>3</b>
<b>601 Opt. 18 Stove Controls On Front or Side.</b> Are provided.	<b>2</b>
<b>601 Opt. 19 Oven Controls On Front Or Side.</b> Are provided.	<b>2</b>
<b>601 Opt. 20 Roll-Under Range.</b> Is installed.	<b>3</b>
<b>601 Opt. 21 Microwave oven.</b> Is at countertop height or lower.	<b>3</b>

<b>601 OPTIONS, continued</b>	<b>PTS</b>
<b>601 Opt 22 Microwave oven Drawer.</b> Is installed.	<b>2</b>
<b>601 Opt. 23 Side By Side Refrigerator or Freezer On Bottom.</b> Is installed.	<b>2</b>
<b>601 Opt. 24 Rounded or Contrasting Counter Edges.</b> Are installed.	<b>2</b>
<b>601 Opt. 26 Built-In Task Lighting</b> Is installed according to <u>Section 1101 Opt. 2.</u>	<b>2</b>
<b>601 Opt. 26 Switches and Outlets over counter on back wall.</b> Are easy to reach near the end of the counter and/or are placed at the front edge of base cabinets.	<b>2</b>
<b>601 Opt. 27 Switches and Outlets Over Counters on side wall.</b> Are no more than 21" from the front edge on a side wall.	<b>2</b>
<b>601 Opt. 28 Island Switches and Outlets.</b> Are easy to reach.	<b>2</b>
<b>601 Opt. 29 Touch Latch Hardware.</b> Is installed.	<b>2</b>
<b>Total Points</b>	

<b>701 Laundry Room</b>	<b>NA</b>	<b>NO</b>	<b>YES</b>
<b>701.1 Location.</b> Is on an accessible route.			
<b>701.2 Clear Floor Space.</b> A 48" x 48" minimum clear floor space is provided at the washing machine, clothes dryer and laundry tub/sink.			
<b>701.3 Turning Space.</b> If the laundry appliances are located within a room a 5' Diameter Turning space is provided.			
<b>701.4 Doors.</b> Doors comply with <u>Section 201.</u>			
NA Justification:			

<b>701 OPTIONS</b>	<b>PTS</b>
<b>701 Opt. 1 Main Floor Location.</b> Is provided on an accessible route.	<b>3</b>
<b>701. Opt. 2 5' Diameter Turning Space.</b> Is provided.	<b>3</b>
<b>701 Opt. 3 Front Loading Washer &amp; Dryer.</b> Are provided.	<b>3</b>
<b>701 Opt. 4 Front Appliance Controls.</b> Are provided.	<b>2</b>
<b>701 Opt. 5 Raised Appliances.</b> Are installed.	<b>2</b>
<b>701 Opt. 6 Easy Reach Operable Parts.</b> Are provided.	<b>2</b>
<b>701 Opt. 7 Built-In Task lighting.</b> Is installed according to <u>Section 1101 Opt. 2.</u>	<b>2</b>
<b>Total Points</b>	

<b>801 Living Room</b>	<b>NA</b>	<b>NO</b>	<b>YES</b>
<b>801.1 Location.</b> There is at least one living room or family room on the main floor, on an accessible route.			
<b>801.2 Turning Space.</b> There is a 5' diameter turning space.			
<b>801.3 Changes in Level.</b> Comply with <u>Section 104.3.</u>			
<b>801.4 Doors.</b> Comply with <u>Section 201.</u>			
<b>801.5 Flooring.</b> Complies with <u>Section 901.</u>			
NA Justification:			
<b>901 Flooring</b>	<b>NA</b>	<b>NO</b>	<b>YES</b>
<b>901.1 Changes in Level.</b> Comply with <u>Section 104.3.</u>			

<b>901 Flooring, continued</b>	<b>NA</b>	<b>NO</b>	<b>YES</b>
<b>901.2 Floor Registers.</b> Comply with <u>Section 901.1</u> or are flush with the floor.			
NA Justification:			
<b>901 OPTIONS</b>			<b>PTS</b>
<b>901 Opt. 1 Hard Surface Flooring.</b> (Tile, wood or linoleum) and/or non-slip flooring (slip resistant or non-glazed ceramic tiles or linoleum products) are installed in some accessible areas of the home.			<b>2</b>
<b>901 Opt. 2 Low Pile Carpet.</b> Low-level loop or commercial grade carpet is installed with either no padding or with thin, firm padding.			<b>2</b>
<b>901 Opt. 3 Slip Prevention Paint or Traction Strips.</b> Are used to prevent slipping in areas that might get wet (e.g. bathtub, garage floor and/or steps).			<b>3</b>
<b>901 Opt. 4 Color Contrast.</b> A contrasting color border is installed.			<b>2</b>
<b>Total Points</b>			

<b>1001 Window OPTIONS</b>	<b>PTS</b>
<b>1001 Opt. 1 Operable Components.</b> Are within 20" to 44" above the finished floor.	<b>3</b>
<b>1001 Opt. 2 Window Hardware.</b> Does not require fine fingering.	<b>2</b>
<b>1001 Opt. 3 Automatic Window Openers.</b> Are installed.	<b>3</b>
<b>1001 Opt. 4 Automated Window Coverings.</b> Are installed.	<b>3</b>
<b>1001 Opt. 5 Extended Window Covering Controls.</b> Are installed.	<b>1</b>
<b>Total Points</b>	

<b>1101 Lighting</b>	<b>NA</b>	<b>NO</b>	<b>YES</b>
<b>1101.1 Exterior Lighting.</b> Is provided near all entrances so things such as the front door, porch, keyhole, keypad and house number are clearly visible.			
NA Justification:			
<b>1101 OPTIONS</b>			<b>PTS</b>
<b>1101 Opt. 1 Exterior Lighting.</b> Is installed along walks and pathways, decks, balconies, and auxiliary buildings.			<b>2</b>
<b>1101 Opt. 2 Built-In Task Lighting.</b> Is installed.			<b>2</b>
<b>1101 Opt. 3 Remote Controls.</b> For ceiling fans/lights are installed.			<b>3</b>
<b>1101 Opt. 4 Lighted Door Bells.</b> Are installed.			<b>2</b>
		<b>Total Points</b>	

<b>1201 Lighting Controls, Electrical Switches and Outlets</b>	<b>NA</b>	<b>NO</b>	<b>YES</b>
<b>1201.1 Electrical Panel Box.</b> The electrical panel box is on an accessible route.			
<b>1201.2 Electrical Panel Box Clear Floor Space.</b> A clear 32" x 48" floor space is provided at the electrical panel box.			
<b>1201.3 Door.</b> Any door or doorway directly opening into the electrical panel box location has a clear opening width of 34" in accordance with Section 201.2.			
<b>1201.4 Electrical Panel Box Upper Fuse Height.</b> The upper most fuse switch is a maximum of 54" above the finished floor.			
NA Justification:			



<b>1201 OPTIONS</b>		<b>PTS</b>
<b>1201 Opt. 1 Electrical Panel Box Location.</b> Is on the main floor or in the garage.		<b>3</b>
<b>1201 Opt. 2 Outlets 18"–24" High.</b> Are installed.		<b>3</b>
<b>1201 Opt. 3 48" Max. Switch Heights.</b> Are installed.		<b>3</b>
<b>1201 Opt. 4 Rocker Switches.</b> Are installed.		<b>3</b>
<b>1201 Opt. 5 Dimmer Switches</b> Are lighted or have large controls.		<b>2</b>
<b>1201 Opt. 6 Three or Four-Way Switches.</b> Are installed.		<b>3</b>
<b>1201 Opt. 7 Programmable Lighting.</b> Is installed.		<b>3</b>
<b>1201 Opt. 8 Motion Activated Lights or Motion Detectors.</b> Are installed.		<b>3</b>
<b>Total Points</b>		

<b>1301 Heating, Ventilation and Air Conditioning (HVAC)</b>	<b>NA</b>	<b>NO</b>	<b>YES</b>
<b>1301.1 Thermostat.</b> Is on an accessible route, according to <u>Section 101</u> .			
<b>1301.2 Thermostat Clear Floor Space.</b> A 32" x 48" minimum clear floor space is provided at the thermostat for either a parallel or perpendicular approach.			
NA Justification:			
<b>1301 OPTIONS</b>			
<b>1301 Opt. 1 Furnace On Main Floor.</b> Is installed.			<b>3</b>
<b>1301 Opt. 2 Furnace Clear Floor Space.</b> 32" x 48" minimum clear floor space is provided.			<b>3</b>

<b>1301 OPTIONS, continued</b>	<b>PTS</b>
<b>1301 Opt. 3 54" Max. Thermostat Height.</b> Is installed.	<b>3</b>
<b>1301 Opt. 4 Programmable Thermostat.</b> Is installed.	<b>3</b>
<b>1301 Opt. 5 Easy To Read Thermostat.</b> Is installed.	<b>2</b>
<b>1301 Opt. 6 Remote Controls.</b> Are installed.	<b>3</b>
<b>1301 Opt. 7 Furnace Filter.</b> Is easy to reach and change.	<b>2</b>
<b>1301 Opt. 8 Air Conditioning.</b> Air conditioning is installed.	<b>3</b>
<b>Total Points</b>	

<b>1401 Technology and Automation In The Home OPTIONS</b>	<b>PTS</b>
<b>1401 Opt. 1 Remote Control Smoke Detectors.</b> Are installed.	<b>3</b>
<b>1401 Opt. 2 Smoke Detectors Linked to a Security Systems Provider.</b> Are installed.	<b>3</b>
<b>1401 Opt. 3 Visible &amp; Audible Alarms.</b> Are installed.	<b>3</b>
<b>1401 Opt. 4 Gas Detector(s).</b> Are installed.	<b>3</b>
<b>1401 Opt. 5 Fire Extinguishers.</b> Are provided.	<b>3</b>
<b>1401 Opt. 6 Security/Surveillance System.</b> Is installed.	<b>3</b>
<b>1401 Opt. 7 Remote Deadbolt Locks.</b> Are installed.	<b>3</b>
<b>1401 Opt. 8 Intercom System.</b> Is installed between 42"-48" above the finished floor.	<b>3</b>

<b>1401 OPTIONS, continued</b>	<b>PTS</b>
<b>1401 Opt. 9 Voice Control System.</b> Is installed.	<b>3</b>
<b>1401 Opt. 10 T-Loop Transmitter System.</b> Is installed.	<b>3</b>
<b>1401 Opt. 11 Environmental Control Unit.</b> Is installed.	<b>3</b>
<b>1401 Opt. 12 Programmable HVAC System.</b> Is installed.	<b>3</b>
<b>1401 Opt. 13 Home Air Purifier.</b> Is installed.	<b>3</b>
<b>1401 Opt. 14 Central Vacuum.</b> Is installed.	<b>3</b>
<b>1401 Opt. 15 Wall-Mount Phones.</b> Are installed between 42"–48" high above the finished floor, measured at the top of the unit.	<b>3</b>
<b>1401 Opt. 16 Home Network System.</b> Is installed.	<b>3</b>
<b>1401 Opt. 17 Internet Connections.</b> Are installed.	<b>3</b>
<b>1401 Opt. 18 Wireless Internet.</b> Is installed.	<b>3</b>
<b>Total Points</b>	

# ZeroStep Guideline Notes



## Chapter 1. Exterior Accessible Routes and Spaces

### 101 Components of an Accessible Route and Accessible Home Design

A zero-step entrance is convenient for all ages and abilities. One can push a baby stroller, roll a wheelchair, or move in appliances and furniture easily over the threshold when there are no steps and the threshold is level or appropriately beveled. It is also safer in inclement weather, such as ice and snow, not to traverse steps.

A walking surface not steeper than 1:20 allows most people to easily and safely traverse up or down a slope. A gentle slope is preferable to a ramp.

A 60" turning space allows more than one person to function comfortably in a space when necessary. It also allows a person in a manual wheelchair to maneuver with ease. A motorized wheelchair requires a 72" turning space.

Thirty-four inch minimum clear door opening widths improves movement and reduces door jamb damage. They provide enough space for wheelchairs to pass through without difficulty.

Ramps and elevators have very specific construction requirements that are regulated by state or local codes.

Forty-two inch wide, or larger, hallways provide comfortable traffic and air flow. Two people can pass, and a wheelchair or other mobility device can be maneuvered with ease without scuffing walls and woodwork.

Stairs should be at least 36" wide or larger to provide comfortable traffic flow. Large bulky items, such as furniture and home entertainment systems, can be moved easily and safely through a 42" wide stairway. A stair guide or stair lift can be installed if needed in the future without modification.

A 48" x 48" clear floor space provides comfortable maneuvering space for more than one person, around bathroom and kitchen fixtures, as well as accommodates a wheelchair approach from the side and the front.

One of the most important features of a ZeroStep universally designed home is not only the accessible route but also the accessible spaces within the home. A main floor, full size, universally designed bathroom is like an insurance policy. It is designed for safety and ensures that people with a mobility aide can easily and quickly use the bathroom. You may say, “but we don’t have any mobility problems in our family.” That’s wonderful, but like any insurance policy, an unexpected temporary disability may occur, such as a sports injury or knee surgery, making it difficult to climb stairs. Also, by having a first floor bathroom, it is possible for people with a mobility aide to visit.

A main floor bedroom is another component of a well-designed ZeroStep home. The bedroom should be near a bathroom and have sufficient clear floor space (5’ foot turning space) for maneuvering around, even with the furnishings in place.

Obviously, an accessible closet makes sense with an accessible bedroom! It is easy to design a closet for easy access by thinking about variable height components for a variety of people’s reach ranges.

Kitchens are about being able to easily move through the space and reach the upper cabinets, electrical outlets and switches, and safely use the appliances and sink. Because everyone uses a kitchen, from the youngest member of the family to the oldest, the “one size fits all” approach does not work. Therefore, it makes sense to think about people’s sizes and abilities, its various uses and users, reach ranges, and the location of appliance controls.

Often the laundry room is given little attention and yet a lot of time is spent laundering clothes. It does not take much to design a very efficient and functional laundry room that reduces binding and stooping while reaching for clothes. Placement on the main floor is best, if possible.

The living room or family room is usually on the main floor yet insufficient consideration is given to circulation patterns, or to appropriate flooring, lighting, electrical switches and outlets, and ventilation. A ZeroStep universally designed home takes these components into consideration for a more enjoyable and livable space.

In order to approach, enter or leave a home, exterior lighting is necessary during dusk and night time hours. Falls can be avoided with well-lit walkways and driveways. Adequate lighting at the door makes it easy to see the lock or the house numbers.

The electrical panel box gets very little consideration, if any. It is one of those things that are typically put in the basement or some out of the way space. Yet, the electrical panel box becomes quite important when a circuit breaker trips and the power goes out. It should be located where it can be easily reached.

The thermostat is also another item that frequently is installed high on the wall and out of easy eye sight or user reach range. A thermostat should be easy to see, use, approach and access.

## 102 Driveways

### **102 Opt. 1 16' Minimum Width By 8' Minimum Length Loading/Unloading Zone.**

A 16' minimum width loading/unloading zone allows an 8' wide vehicle, 3' width on the driver's side and 5' width on the passenger side. The 5' width aisles on the passenger side is sufficient space for a wheelchair lift if the need should arise. Overall, improved circulation space makes for safe and easy mobility between the car and the home for every family member.

## 103 Garage

### **103.1 Minimum Measurements – One Stall.**

A one stall, accessible garage allows 8' width for an automobile, a 3' wide access aisle on one side of the vehicle and a 5' wide access aisle on the other side of the vehicle for a minimum total width of 16'. Additional width may be required for equipment storage.

The 24' garage depth allows a 3' minimum width access aisle in front of the vehicle, a 3' minimum width access aisle behind the vehicle, and 17' for the vehicle length. A minimum garage depth of 26' may be required for trucks and/or equipment storage.

### **103.2 Minimum Measurements – Two Stall.**

Typically, a two stall garage ranges between 20' x 20' and 22' x 22'. These sizes work until space is needed for a wheelchair user. Then, the typical two stall garage becomes a one stall garage because the second auto space is needed for wheelchair access.

An accessible, two stall garage is a minimum of 27' wide x 24' deep. The garage width allows 16' for two automobiles (8' per vehicle), two 3' wide access aisles and a 5' wide access aisle. In total, this allows sufficient space for a custom conversion van with loading device and a second automobile inside the garage. Additional width may be required for equipment storage.

The 24' garage depth allows a 3' minimum width access aisle in front of the vehicle, a 3' minimum width access aisle behind the vehicle, and 17' for the vehicle length. A minimum garage depth of 26' may be required for trucks and/or equipment storage.

### **103 Opt. 1 Slope Entire Garage Floor.**

Many people think there must be a step between the attached garage and the home entrance. This is not true. There must be a sloped garage floor that facilitates the movement of liquids to a drain or toward the main vehicle entry doorway. Steps and ledges are tripping hazards. By eliminating steps and gently sloping the garage floor up to the door threshold, it is safer and easier for young and old to transport things between the house, automobile and garage.

### **103 Opt. 3 9' Minimum Garage Door Height.**

Conversion vans or raised, high-top van roofs add height to the vehicle. A lowered floor full-size van can typically enter through an 8' high garage door. A raised roof and door, full-size van requires a 9' high garage door.

### **103 Opt. 4 Electric Garage Door Opener.**

“An automatic garage door opener can eliminate the daily struggle to get into and out of the garage. Special features like keyless entry systems provide secure access without keys or doorknobs and electronic sensors prevent people or items from being crushed under the door.”  
Baldrice, Nancy, Creating the Accessible Home: Updating Your Home for Changing Physical Needs, Creative Publishing International Inc.

### **103 Opt. 6 Door Swing.**

Often the door between the garage and an attached home has a screen door which opens out, into the garage space. When open, this door blocks an accessible route into the home and therefore it is best to avoid this situation.

## **104 Walks and Pathways**

### **104.1 Slope.**

If the slope around the house is too steep, it prevents usable living and play area space.

### **104.4 Clear Width.**

A wide walkway allows two people to walk side by side without stepping off and facilitates easy transportation of yard equipment, such as a wheel barrow and the lawn mower. Children like a wide walkway to play on, too.

### **104 Opt. 3 Firm, Stable, Non Slip Surface Materials.**

Walkways built with solid surface construction, such as concrete or asphalt, are better than landscaping blocks, flagstones or decorative rock. Most concrete surfaces should be finished with a surface texture, otherwise they can be slippery.

### **104 Opt. 5 Lighting.**

Exterior lighting along the walkway is simply a matter of safety.

## **105 Porches, Patios, Decks and Landings**

### **105.1 Location.**

Sliding doors to porches, patios and decks must provide a clear width opening of 34", which a typical 6' slider does not. Also, sliding door tracks are difficult for people using strollers, walkers and wheelchairs to traverse.

### **105.2 Turning Space.**

A 60" turning space allows a wheelchair to turn around on a porch, patio, deck and landing. It also allows more than one person to be on the porch at a time.

### **105 Opt. 1 Shelf.**

A shelf or bench is extremely convenient when one's hands are full and trying to unlock and open

the door.

## 106 Ramps (See local codes first.)

### General Information:

- Check your local ordinances for ramp criteria and required setback from property lines
- It is ideal to grade and landscape the lot so there is no need for a ramp.
- “Ramps can provide an architectural focal point and widely appreciated presence, enhancing a site rather than detracting from it. A ramp can be designed to complement the décor of the house. If the house is built with brick, for example, the ramp supports can be made of the same brick laid in a complementary pattern.” Wylde, Margaret A., Building for a Lifetime: The Design and Construction of Fully Accessible Homes, Tauton Press, Inc., p. 57.
- “Ramps can be built from concrete or asphalt. But if it needs to rise more than 1 ft. above the ground, it may have to be constructed from wood or metal and suspended on a frame to reduce costs.” Wylde, Margaret A., Building for a Lifetime: The Design and Construction of Fully Accessible Homes, Tauton Press, Inc. p. 57.

### 106.2 Slope.

“A residential ramp that is built to minimum ANSI or UFAS standards is not necessarily good enough. A ramp at a 1:12 slope can be very difficult for people to climb, either in a wheelchair or walking.” Wylde, Margaret A., Building for a Lifetime: The Design and Construction of Fully Accessible Homes, Tauton Press, Inc. (p. 57)

The maximum slope for a ramp shall be 1:12. Sometimes 1:12 can be too steep for the user. If possible, build a ramp closer to 1:20. It is important to be aware of the user’s physical abilities both now and in the future. You may want to consider a professional evaluation by an Occupational Therapist or a Physical Therapist.

### 106.4 Clear Width.

A ramp with a width of 42”–44” allows someone with a mobility device and another person to comfortably use the ramp side by side.

If a 36” wide ramp is considered, it is highly recommended that the client consult with an Occupational Therapist and have an evaluation on whether this is a viable solution. Usually, a 36” wide ramp is only suitable for children. It is not long before the ramp must be redesigned as the child grows and requires a larger wheelchair.

### 106.5 Rise.

A ramp slope of 1:12 and a maximum vertical rise of 30” requires a 30’ long ramp. Thirty feet is a long ramp run for many wheelchair users who have less strength and endurance. It is best to interrupt the 30’ ramp run with a landing for a resting spot.



### **106.7 Edge Protection**

Edge protection must prevent a 4 inch diameter ball or wheel from going over the edge of a ramp. This could be an edge that is built up from the ramp floor, such as a concrete ledge, or it can be a baluster that has a rail to allow drainage under it.

It is best to consider the climate. It may be preferable to have balusters for edge protection, rather than a curb, for easy snow removal.

Also, the terrain should gently slope way, not suddenly drop off at the edge of the ramp.

### **106.11 Ramp Surface.**

It is important to use non-slip or slightly textured surfaces, such as a broomed cement or waterproofing with grit.

## **Chapter 2. Interior Accessible Route and Spaces**

### **201 Doors and Doorways**

#### **201.1 Two or More Zero-Step Exterior Entrances.**

Two or more zero-step entrances exponentially increases accessibility. The primary means of entrance varies between habitants, and having two zero-step entrances ensures that there are options to choose the means of egress to a home. Having 2 means of egress out of a home increases the safety of the building. Make all entrances zero-step if possible. National associations such as the Veterans Administration and AARP will only fund a home if there are two zero step entrances.

#### **201.3 Minimum Maneuvering Clearances.**

Having a clear maneuvering space on the latch-side of a door allows people of any handedness and using varying methods of approach access to the operating parts.

#### **201 Opt. 1 Sidelites.**

Windows beside the doors, such as sidelites, permit a view of visitors, which is beneficial for everyone.

#### **201 Opt. 4 Lever Door Hardware.**

Lever handle hardware allows easy access to all users. A child can open a door with this type of handle. If one's hands are full of packages, a lever can be operated easily with an elbow. If one's hand strength or grip is limited, the door can be easily opened with a closed fist.

#### **201 Opt. 5 Automatic Door Opener.**

There are many types of automatic door openers. They are convenient and sometimes necessary for maximum independence by the user.

“If limited hand or arm strength is an issue, consider an automatic door opener to open and hold entry doors between the garage and the house. Look for models that offer adjustable timing and automatic locking mechanisms for added convenience. (Wylde, Margaret A., Building for a Lifetime: The Design and Construction of Fully Accessible Homes, Tauton Press, Inc., p. 98.

## 202 Hallways

### **202 Opt. 1 Width Greater than 42".**

Wider hallways allow for easy carrying of oversized or bulky items such as laundry baskets, suitcases and furniture without marring the walls and clear door jambs. They also increase air flow and circulation.

## 203 Stairways

### **203 Opt. 1 No Open Risers.**

Open risers are not recommended. One could trip on an open riser and small children can fall through them.

### **203 Opt. 3 Deeper Treads and Lower Risers.**

- Lower risers are easier to navigate, particularly if one has limited range in stepping. Deeper treads accommodate a quad cane or a larger foot size. This type of stairway design works well for children, too.
- Steps should not have nosings; (nosings are the part of the tread that extend beyond riser.) Nosing projections are dangerous to the elderly.
- Uniform treads are preferred over those that curve around the corner, creating “wedge” shaped treads where it is easy to slip on the narrow part.

### **203 Opt. 5 Two Handrails.**

Handrails are extremely important for safety reasons. It is important to have handrails that one can easily grasp, otherwise they are of little benefit. Think about the fit first and then the shape. They should not be more than 1 ½" in diameter, and round is best. When a person can completely get their fingers around the handrail, they have the best grasp and strength in case of a slip. Handrails should support the weight of an adult and need firm anchoring. A handrail should also extend 12" beyond the last step if possible.

### **203 Opt. 7 Handrail Terminations.**

Handrail terminations are important primarily so that people do not accidentally bump into the end of the rail and hurt themselves or get a piece of clothing caught, causing them to trip and fall.

### **203 Opt. 11 Stair-Lift or Incline Platform Lift.**

Electrical wiring involves simply installing the appropriate type of electrical outlet at one of the stair landings. A stair lift takes the typical electrical outlet, while an incline platform lift requires either a 220 or a 110 dedicated outlet, depending upon the model.

A straight stairway makes it easier and cheaper to install a stair-lift. A stair-lift allows a user who cannot navigate steps to access areas of the home that would otherwise be unattainable. The user sits on a chair or rolls onto a platform and rides to the destination. This is considered a type of elevator and must be installed by a professional with an elevator license. Be sure to check with your local codes before installing a stair-lift.

## 204 Elevators

### **204 Opt. 1 Stacked Walk-in Closets.**

On a two-story home, "stacking" large closets allows for the installation of an elevator, without major reconstruction of the home interior, should one be necessary in the future. Consider the elevator size that may be needed when determining the interior closet clearance dimensions.

## Chapter 3. Bathrooms

### 301 Bathrooms

#### **301.1 Location.**

By having an accessible bathroom near an accessible bedroom, bathing and toileting are more convenient for any user. It eliminates the need to navigate long distances to the other end of the house, for example.

#### **301.2 Turning Space.**

A 60" turning space in the bathroom allows for more than one user to comfortably function in the bathroom. It also allows for a wheelchair to turn around.

#### **301.3 Clear Floor Space.**

Clear floor space allows easy approach and maneuvering around bathroom fixtures. (Some motorized wheelchairs, for example can require more space than 48" x 66".)

#### **301.4 Toilet Clear Floor Space.**

The toilet requires the most clear floor space of all bathroom fixtures because of the diverse number of approaches needed if one uses a wheelchair. (Some motorized wheelchairs, for example can require more space than 48" x 66".)

#### **301.6 Wall Reinforcement.**

We do not recommend using  $\frac{3}{4}$ " plywood for reinforcing entire walls because it isn't as strong as blocking. Also, the bathroom would have to be 1- $\frac{1}{2}$ " larger if entire walls are reinforced. We suggest extending the wood blocking area for greater chance of hitting the reinforced area when installing grab bars and for greater personalization of grab bar locations.

#### **301.7 Wall Reinforcement Documentation.**

Without proper documentation accurately depicting or photographs showing the wall reinforcement locations, it is extremely difficult to (1) know if it has been provided and (2) where

it has been provided, especially for new residents in the home. Documentation is a vital piece of information that helps avoid unnecessary wall demolition when installing future grab bars.

### **301.8 Bathtub/Shower Stall Clear Floor Space.**

A clear floor space along the entire length of the bathtub allows for a future roll-in shower if ever needed. Larger clear floor spaces allow a person to easily wash a child or pet in the tub.

- A permanent built-in bathtub seat is not required or preferred. If the homeowner requests a built-in bathtub seat, be sure to consider how the user will:
  - Transfer
  - The seat size and location
  - Back support, if needed
  - Overall height adjustability
  - Location of the faucets in relation to the seat
  - Location of the grab bars in relation to the seat
- A manufacturer's built-in bathtub seat is also discouraged. The manufacturer's built-in seats are frequently too shallow, too slippery and too far away from standard faucet control locations. (The same holds true for a built-in shower seat.)
- A freestanding bathing chair is the best choice as it meets the above requirements.
- Bathtub door enclosures are not required or preferred because of safety and accessibility issues. Often, the enclosure handles are the first thing a person grabs when falling, yet the door does not support the downward force, nor do they remain stationary. Also, many enclosure models limit up to half the entrance to the bathtub, making it impossible to use a freestanding transfer bench if required, and challenging to bath a child.
- Beveled or sloped bathtub edges prevent using future grab bars that mount on the side of the tub. Some molded bathtub corners prevent using free standing tub chairs. Acrylic bathtub/showers often have undulating surfaces which must be reinforced by the manufacturer or on the job site. No hollow spaces are permitted where future grab bars could be installed.
- Claw foot bathtubs are not recommended unless they meet all bathtub and grab bar design criteria previously mentioned.
- A 30" x 60" bathtub can be converted into a roll-in shower if necessary.

### **301.9 Bathtub Height.**

Increasing the overall bathtub height, by placing it on a concrete slab with the pipe above the slab, creates an even taller tub wall to clear upon entering the bathtub. A tall tub wall makes it difficult to nearly impossible for a child or a user with limited stepping range to safely access the bathtub. Plumbing pipes should be located underneath the concrete slab in order to keep the tub at the standard height.

### **301.10 Toilet.**

A toilet closet is not recommended unless it contains a 5' turning diameter clear floor space.

- Toilets and toilet seats can be easily replaced if height becomes an issue. Custom adjustable height seats are available.
- Custom height is allowed to meet the needs of the individual, who may be seated, short or tall.

### **301.11 Shower Stall.**

If using a freestanding, shower seat, a 30" x 60" walk-in shower is very tight. A 4' x 6' space is preferred and two people can function within that space, such as an aide and the bather.

A manufacturer's built-in, molded shower seat is not recommended. These seats are not functional. They are slippery, not adjustable, do not provide real back support, are often not the right size for the user, and are difficult or impossible to transfer to. The molded seat takes up floor space in the shower, making it difficult or impossible to use a freestanding shower seat. If a custom built-in seat is used, consider the user's transfer method and physical ability, the seat location, size, seat height and the faucet location. A freestanding seat is usually the best choice.

### **301.12 Sink Cabinet.**

The 36" wide cabinet without a center stile allows someone to use the sink in a seated position.

### **301.13 Exposed Pipes.**

"On sinks that are open underneath, the drain and hot-water pipes should be covered or insulated to prevent a person from being burned. Many people cover the pipes with a foam insulation sleeve, which is effective, but not too attractive. A better choice might be to build a baffle..." Wylde, Margaret A., Building for a Lifetime: The Design and Construction of Fully Accessible Homes, Tauton Press, Inc., p. 181.

### **301 Opt. 2 2nd Accessible Full-Size Bath – Main Floor.**

"Having two bathrooms solves several problems. First, one may be public and the other private. A public bath should be placed so that it can be reached by guests without their having to walk through bedrooms or other private spaces within the house. ...Two bathrooms keep the peace in a family trying to prepare for work, school or play at the same time." Wylde, Margaret A., Building for a Lifetime: The Design and Construction of Fully Accessible Homes, Tauton Press, Inc., p. 165.

### **301 Opt. 4 No Doors Swing in 5' Turning Space.**

If a door swings out of the bathroom, rather than into the bathroom, it allows more space within the bathroom for the user. A pocket door is an excellent way to accomplish this. The only warning about a pocket door is that no grab bars may be installed where the pocket is located.

### **301 Opt. 5 Bathroom Doors Swing Out.**

If space is limited, swinging a door out increases the amount of maneuvering space within the bathroom. Another benefit of the door swinging out of the bathroom is if a person falls in front of the door, someone can assist them. Consider the user; in some cases an outward swing may be difficult to operate.

### **301 Opt. 6 Wall Reinforcement Extended.**

By expanding the wall reinforcement areas for future grab bars, it is possible to mount the grab bars in the best location for a particular user.

### **301 Opt. 7 Wall Reinforcement Documentation Permanent Installation.**

It is very important to document wall reinforcement locations for future grab bars. Without this document, new residence owners have no idea if installing grab bars shall be a major or a minor remodeling project.

By providing permanent documentation, both present and future homeowners know that reinforcement exists, and it prevents unnecessary modification. The documentation could be mounted inside a bathroom cabinet door.

### **301 Opt. 8 Grab Bars Installed.**

- Grab bars assist everyone.
- Diagonal grab bars should be used sparingly. Horizontal grab bars promote good body mechanics. Do not use anchor bolts without wall reinforcement.
- Pull down grab bars are mounted securely to the wall and can pull down or fold out when needed, or fold out of the way when not needed.
- Floor mount grab bars are ideal when there is no wall or stud in the wall to attach a grab bar. Depending on the user, the location of the bar and style will vary, and can make the difference between independent and dependent transfers. An occupational or physical therapist consultation is highly recommended.
- Lowered towel bars may be helpful to some clients, but they should not be used as grab bars. Grab bars, on the other hand, can be used as towel bars.

### **301 Opt. 9 Comfort Height Toilet.**

Comfort height toilets are 17"–19" from the floor to the seat. Consider the user when selecting a comfort height toilet. Comfort height makes sit-to-stand toilet transfers easier for average height users. Petite users may prefer lower height. Tall users may need an additional seat riser for maximum comfort.

### **301 Opt. 10 Bidet or Toilet Seat with Bidet Functionality.**

A bidet or toilet seat with bidet functionality is an alternative to toilet paper and improving cleanliness. "Hydro-cleansing" ensures a comfortable water temperature that is suitable for young and older adults.

### **301 Opt. 11 Mirror Mounting Height.**

When a mirror is mounted with the bottom edge no higher than 40" above the finished floor, a person is able to use it from a seated position. A child can also use it at this height.

### **301 Opt. 13 Shut-Off Valves.**

Typically, a homeowner does not consider where the shut-off valves are located for sinks and toilets; however this is an important consideration when facing a plumbing emergency. Mounting the shut-off valves higher on the wall can assist those who are not able to easily reach behind a toilet and near the floor.

### **301 Opt. 15 Space Under Sink.**

“The open knee space may be achieved by several means: by a removable vanity where brackets support the countertop and a removable protection panel covers the water pipes and drain, or a vanity with fold back or self-storing doors, or a pedestal sink (note: pedestal sink can hinder knee and toe space), or by installing a wall mount lavatory (which is actually the best). If there is an open space under the sink, pipes need to be offset and insulated (see Exposed Pipes and Surfaces) or have a panel to hide the pipes and protect a seated person’s knees.”  
Wylde, Margaret A., Building for a Lifetime: The Design and Construction of Fully Accessible Homes, Tauton Press, Inc.

Sinks mounted at 32" – 34" at rim above the finished floor permit a person to easily reach the faucets from a seated position. Consider the height of the user.

### **301 Opt. 17 Levers or Handle on Faucet Control.**

Lever hardware is easier for all users to operate. If the hand grasping function is limited or the hands are greasy, the user can operate lever faucets with a closed fist or an elbow.

Single lever handle faucets have a mix valve that regulates water pressure and water temperature built into the faucet. Two lever handle faucets do not have a mix valve; however it is available and can protect people from eliminating hot and cold water surges while bathing. A mix valve is about personal preference. Some people may need extremely hot water for therapeutic reasons.

### **301 Opt. 18 Sink Faucet Location.**

Locating the faucet control along the side of a sink makes it within easy reach for children and for those in a seated position.

### **301 Opt. 20 Scald Guard.**

A mix valve is a safety measure that prevents water scalding people and/or sudden pressure changes. However, some people need extremely hot water for therapeutic reasons.

### **301 Opt. 21 Bathtub 36" Deep Clear Floor Space.**

Thirty-six inches of clear floor space along the entire length of the tub allows for a large roll-in shower to be installed in the future, if the need should arise. Also, more space in front of the bathtub makes bathing a child or pet easier.

### **301 Opt. 22 Bathtub Height.**

Occasionally, with on slab construction, the bathtub plumbing is installed above the concrete slab, causing the overall bathtub height to exceed 16". By locating the plumbing under the concrete slab, the overall bathtub height remains easily accessible.

### **301 Opt. 23 Accessible Bathtub.**

A walk-in style bathtub with a door may be ideal for a particular user. They must be able to step over the low edge and be able to get up from a potentially low, seated position. Also, they must wait inside the tub while it is filling or draining.

### **301 Opt. 24 Bathtub/Shower Faucet Control Location.**

By installing the faucet closer to the bathtub or shower stall edge/rim, easy access and operation from outside the tub/shower is possible. For shower stalls, consider locating the plumbing in two places—on the side wall and an end wall.

### **301 Opt. 25 Hand Held Shower.**

A hand held shower head with a 6' hose on an adjustable slide bar is recommended with a shower/tub seat. Shorter hoses do not always reach the seat and dangle out of reach. A 6' hose can rest on the seat within easy reach, while the slide bar allows adjustability according to any user's height. It is also convenient for cleaning a tub/shower or the family pet.

### **301 Opt. 31 Shelving.**

Locate shelving such that it is easy to reach from a seated position and does not interfere with future grab bars. The front corner of the bathtub or shower is typically the best location.

### **301 Opt. 32 Telephone Jack.**

Having a telephone in the bathroom is ideal for emergencies.

## **Chapter 4. Bedrooms**

### **401 Bedrooms**

#### **401.1 Location.**

"There must be sufficient clear space for maneuvering around furniture and accessible closets for storing clothing, linen and bedding. Adequate wiring for lights, communication devices and medical equipment is essential. Because the bedroom may not always remain a bedroom, it should be able to be converted to other uses, such as a home office or an in-law apartment." Wylde, Margaret A., Building for a Lifetime: The Design and Construction of Fully Accessible Homes, Tauton Press, Inc., p. 192.

The 5' turning space in a bedroom can be easily lost due to furniture placement. The best way to plan the bedroom is to evaluate the room's circulation pattern and the most likely location for the bed. Typically, the 5' turning space is close to the bedroom entrance.

#### **401 Opt. 3 Emergency Escape Window Exceeds Michigan Building Code.**

- "All bedrooms should have a window or door that allows an emergency escape to the outside of the house. An escape window should be big enough to allow people to get through it and out. First the sill needs to be at a height that is accessible to all. The preferred height is 18" to 20", since the height of most wheelchair seats is 18" to 20", and sill heights at this level provide an easier transition from chair to window. Many home owners, however, do not want windows with low sills for reasons of privacy and because they are hazardous in children's play areas." Wylde, Margaret A., Building for a Lifetime: The Design and Construction of Fully Accessible Homes, Tauton Press, Inc., p. 194.



- “Upper-story bedrooms need an exterior escape route to the ground below. You need a balcony or platform, ladder, or exterior stairs built into the house or available so that everyone on the second floor may evacuate safely.” Wylde, Margaret A., Building for a Lifetime: The Design and Construction of Fully Accessible Homes, Tauton Press, Inc., p. 194.

#### **401 Opt. 4 Exterior Emergency Escape Door.**

“An exterior door from a bedroom creates the opportunity for multiple uses in the future. The door can serve as an entrance to an office for a home business. The door may also make it easier to convert the room to a rental or an apartment for a relative. ...A sliding glass door that opens onto a small patio or balcony off the bedroom is a perfect solution to emergency egress and a delightful feature as well.” Wylde, Margaret A., Building for a Lifetime: The Design and Construction of Fully Accessible Homes, Tauton Press, Inc., p. 194.

#### **401 Opt. 5 2 Additional Outlets On Bed Wall.**

“A switched outlet should be installed with a switch at the entrance and another at bedside. Some people appreciate having a switch in their bedroom that controls exterior floodlights. Telephone jacks and cable television cables should be wired into each bedroom. Adequate wiring for lights, communication devices.” Wylde, Margaret A., Building For A Lifetime: The design and construction of fully accessible homes, Tauton Press, Inc., p. 199.

- “Electricity and Communications: Bedrooms should be wired to accommodate a full array of medical equipment, should the need arise. ...They shouldn’t have to compete for outlets... Walls that are likely to have a bed along them should be wired for at least four outlets, and ideally four outlets on each side of the bed.” Wylde, Margaret A., Building for a Lifetime: The Design and Construction of Fully Accessible Homes, Tauton Press, Inc., p. 199.

#### **401 Opt. 6 Bedside Switch Outlet.**

Additional electrical outlets benefit all users. They allow a person to control lights without getting out of bed. They are convenient for alarm clocks, a fan, radio, phone charger, baby monitor and medical equipment. Be certain there are adequate circuits for future, additional electrical loads.

#### **401 Opt. 7 Auxiliary Wiring.**

By including phone jacks, cable TV, internet/computer wiring in a bedroom, the user will be adequately prepared for current and future technology. The future of care giving is moving toward the Internet and related technology

## Chapter 5. Closets

### 501 Closets

#### **501 Opt. 3 Walk-In Closets With 5' Turning Space.**

- Full access, walk-in closets are best for most people, provided that they have an accessible entrance.
- “Wall closets should be designed so that they don’t have blind, inaccessible corners. This can be accomplished by building all closets with a full-length opening. Either hinged or pocket doors may be used.” Wylde, Margaret A., Building for a Lifetime: The Design and Construction of Fully Accessible Homes, Tauton Press, Inc., p. 196.

#### **501 Opt. 4 Adjustable Rod(s).**

Adjustable rods are easy to find in most “big box” stores and closet specialty stores. They offer every member of a household a comfortable, easy reach, whether short or tall.

#### **501 Opt. 5 Shelves.**

Shelves that are between 15" and 48" in height from the finished floor are easy to access without having to bend over or without using a step stool.

#### **501 Opt. 6 Pull-Out or Pull Down Shelves.**

Things can easily fall through wire baskets and may be difficult to retrieve. Full-extension shelves are best.

#### **501 Opt. 7 Drawers.**

Drawers are better than shelves because you can easily reach all the way to the back, whereas shelves often require stooping to see what is towards the back. Use D-shaped or U-shaped hardware that is easy to grip.

## Chapter 6. Kitchens

### 601 Kitchens

#### **601.5 Sink Cabinet**

A 36" minimum width base cabinet with no shelves or center stile, installed under a sink or cooktop, allows a seated person an approach when the cabinet doors are open. This may not be needed at the time of installation, but is extremely beneficial if the need should arise. It saves a lot of headaches looking for matching cabinetry years down the road, not to mention financial savings.

#### **601.6 Counter Width.**

A minimum of 18" wide counter space next to ovens and refrigerators provide sufficient space to set items which may be too hot or heavy to transport without a “resting” spot first.

### **601.7 Sink Exposed Pipes and Surfaces.**

Exposed pipes and hot surfaces should be covered to prevent burns and scrapes, particularly under sinks and cook tops.

### **601 Opt. 2 Pull-Down Shelves.**

If the home owner lowers the wall cabinets, some things like a blender, bread maker and mixer will not fit within the vertical space between the counter and the upper cabinets. To accommodate this needed height, the bottom of the wall cabinet is installed 18" above the countertop and the upper shelves can be made reachable by installing a pull-down shelf mechanism.

### **601 Opt. 3 Glide-Out Shelves/Drawers & Swing-Up Shelves.**

Glide-out shelves, drawers and swing-up shelves maximize storage space as well as provide access to it.

### **601 Opt. 4 Sink Cabinet With Retractable Doors and No Center Stile.**

Automatic, adjustable height sinks are available with just the flip of a switch. They can be used by anyone in a wheelchair, seniors who have difficulty reaching and children.

### **601 Opt. 6 Pull-Out Work Surface.**

A pull-out work surface allows meal preparation from a seated position.

### **601 Opt. 7 Lowered Counter.**

Lower counter heights are ideal for children and others to work from comfortably. Caution: lower counter heights can prevent the installation of some dishwashers.

### **601 Opt. 8 Side Mount or Sprayer Sink Faucet.**

"To get the maximum benefit, choose a faucet that includes all three features - lever handle, pull-out sprayer, and scald-guard device." Baldrice, Nancy, [Creating the Accessible Home: Updating Your Home for Changing Physical Needs](#), Creative Publishing International, Inc., p. 55.

### **601 Opt. 9 Sink Drain In Back.**

By locating the sink drain towards the back of the sink, there is more space for a seated person's knees in front of the sink.

### **601 Opt. 10 Cook Sink.**

A cook sink has multiple functions. It has a heating element that can heat water up to approximate 250°F, and when the temperature control is in the "off" position, the cooking sink can be used as a regular sink. The benefit of a cook sink is that you do not have to carry a heavy pot of water to or from a stove. The sink provides the functions of a standard sink plus any water-based cooking such as, steaming, boiling, poaching, and blanching.

### **601 Opt. 13 Dishwasher Location.**

It is best to locate a dishwasher next to the kitchen sink. This allows easy access to the water and drain lines and is economically installed. It is also the most efficient location since it takes

fewer steps to load and unload. It is not a good idea to install an under the sink dishwasher model for space saving reasons. The space under the sink may need to be accessible someday.

#### **601 Opt. 14 Dishwasher Drawer or Elevated Dishwasher.**

A drawer type dishwasher offers a lot of excellent features. There are single drawer or double drawer units. Each drawer operates independently, so a small load of dishes can be washed as economically as a large load. The dishwasher drawer can be installed lower, making it within easy reach for a seated person. Look for a child lock option for safety reasons. Caution: be sure to note double drawer overall height dimensions.

#### **601 Opt. 15 Scald Guard.**

Scald-guard valves protect everyone against sudden changes in water temperature. Temperature limiting mixer valves also prevent scalds by restricting water temperature at one faucet.

#### **601 Opt. 17 Induction Stove.**

“With an induction stove you can have instant heat. Energy is transferred directly to the cooking vessel. The stovetop itself barely gets warm except directly under the cooking vessel. “No more burned fingers, no more baked-on spills, and no more danger with children around. And for kitchens that need to take into account special needs, such as wheelchair access, nothing, but nothing, can beat induction for both safety and convenience.” Induction units are very thin in the vertical, often requiring not over two inches of depth below the countertop surface. Thus, they allow wheelchair access.

<http://theinductionsite.com/proandcon.shtml>

#### **601 Opt. 19 Oven Controls On Front or Side.**

- “Control knobs on the range or oven should be front-mounted or side-mounted to eliminate the need to reach over hot burners. Appliance dials 1 ½" or greater in diameter are easier to turn. Controls should have readable settings and directions in large print.”  
[www.oznet.ksu.edu/library/HOUS2/MF2213.pdf](http://www.oznet.ksu.edu/library/HOUS2/MF2213.pdf)
- Drop in ranges or cooktops can be installed at the appropriate height for the user. For short or seated users, the most convenient height maybe 30" to 32".
- An angled mirror over the cooktop is helpful to a seated user.

#### **601 Opt. 21 Microwave Oven.**

“Microwave ovens with side-opening doors are safe and easy for most people to use.”

[www.oznet.ksu.edu/library/HOUS2/MF2213.pdf](http://www.oznet.ksu.edu/library/HOUS2/MF2213.pdf)

#### **601 Opt. 22 Microwave Oven Drawer.**

With a microwave drawer, the microwave can come off the counter and be installed at a convenient height for easy accessibility. It can be installed under a counter or in a kitchen island. Look for easy to read and reach controls.

#### **601 Opt. 23 Side By Side Refrigerator Or Freezer On Bottom.**

- There are pull-out and tilt-down bottom drawer freezers, and pull-out shelves for refrigerators.

- “Side by side refrigerator/freezers have accessible space in both the refrigerator and freezer sections for persons with limited reach. Self-defrosting units are easier for persons with limited strength to maintain.”  
[www.oznet.ksu.edu/library/HOUS2/MF2213.pdf](http://www.oznet.ksu.edu/library/HOUS2/MF2213.pdf)  
Note, the controls for side by side refrigerators/freezers are often at the top, making it difficult for someone in a wheelchair to reach them. A 48" high reach zone is recommended.
- A refrigerator with the water/ice maker on the front of the door make for easy access to water and ice without opening the door.

**601 Opt. 24 Rounded Or Contrasting Counter Edges.**

“Color contrasts at the front and back edges of the counter tops serve as visual clues to persons with impaired vision. Light colored counter tops reflect available light and are desirable for persons with limited vision.” [www.oznet.ksu.edu/library/HOUS2/MF2213.pdf](http://www.oznet.ksu.edu/library/HOUS2/MF2213.pdf)

**601 Opt. 25 Built-In Task Lighting.**

“Adequate task lighting is needed in the kitchen. Fluorescent lighting installed underneath wall hung cupboards provides light for working at the countertop.”  
[www.oznet.ksu.edu/library/HOUS2/MF2213.pdf](http://www.oznet.ksu.edu/library/HOUS2/MF2213.pdf)

**601 Opt. 26 Switches and Outlets Over Counters on Back Wall.**

It is possible to mount switches and outlets on the face of the counter or cabinet where they can be easily reached by a seated person. However, this may not be an ideal or safe location for a child.

**601 Opt. 29 Touch Latch Hardware.**

Touch latch hardware is easy to open yet keeps drawers and cabinet doors secure. It does not require fine motor skills and grasping. However, children may be able to get into spaces where they shouldn't.

## Chapter 7. Laundry Room

### 701 Laundry Room

**General Information:**

- A pull-down ironing board can be adjustable for a short or seated person and a standing person. The electrical outlet should be within easy reach.
- A table or counter located near the washer and dryer at a height usable by a short or seated person (28"–30") is useful for sorting and folding clothes.
- It's nice if the laundry room can be located near a bathroom or bedroom as well as be on the main floor.

### **701.1 Location.**

If possible, locate the laundry room on the main floor to avoid using the stairway to the basement.

### **701.2 Turning Space.**

If the laundry appliances are located within a room a 5' diameter turning space ensures sufficient space in which to maneuver in an enclosed area. Provide a larger laundry room so that all activities associated with the laundry, e.g. folding, storing clothes and ironing, can be executed in one space.

### **701 Opt. 2 5' Diameter Turning Space.**

If the laundry appliances are not located within a room, a 5' diameter turning space ensures sufficient space in which to maneuver. This is an option in this case as an accessible route allows for access from either the front or the side. Provide a larger laundry area so that all activities associated with the laundry, e.g. folding, storing clothes and ironing, can be executed in one space.

### **701 Opt. 3 Front Loading Washer And Dryer.**

Front loading appliances are user friendly. They can be easily reached from a seated position and a child can help with the laundry. Avoid stacked washers and dryers because they are not easy for short or seated persons to easily access.

### **701 Opt. 4 Front Appliance Controls.**

Front appliance controls are easy to read from a seated position.

### **701 Opt. 5 Raised Appliances.**

Consider raising appliances to promote most efficient accessibility and good body mechanics.

### **701 Opt. 6 Easy Reach Operable Parts.**

Switches, buttons and touch controls located on the front of the appliance are easy to reach from a seated position and often have locking mechanisms for child safety.

## **Chapter 8. Living Room**

### **801 Living Room**

#### **801.3 Changes in Level.**

Take special care to check transition areas where rooms meet and flooring height varies. Make sure transitions between rooms have vertical offsets that are no higher than ¼", or are beveled 1:2.

## Chapter 9. Flooring

### 901 Flooring

#### General Information:

- “16% of the accidents that occur at home are caused by floors and flooring material.” Buffalo Organization for Social and Technical Innovation, 1982, p. 93.
- A light color floor in a mat finish will reflect light, reduce glare and brighten the work area.
- “If limited vision is a problem, consider painting the floor a light color in a mat finish to reflect light, reduce glare, and brighten the work area.” Baldrice, Nancy, Creating the Accessible Home: Updating Your Home for Changing Physical Needs, Creative Publishing International, Inc., p. 100.

#### 901 Opt. 2 Low Pile Carpet.

- “Wheels and casters move better on low pile, tightly woven (dense) carpeting or hard surfaces. Some industrial grade carpeting is ideally suited for high-traffic rooms with exterior entrances and wheeled objects. It usually has a short pile, thin backing and padding and easy maintenance requirements.” Baldrice, Nancy, Creating the Accessible Home: Updating Your Home for Changing Physical Needs, Creative Publishing International, Inc., p. 93 & 94.
- “Many carpets are rated relative for antistatic capacity, an important consideration in rooms with personal computers (or other microprocessor-based products.) People who use walking aids, particularly those that may be skidded over the floor like a walker, also appreciate anti-static floors.” Baldrice, Nancy, Creating the Accessible Home: Updating Your Home for Changing Physical Needs, Creative Publishing International, Inc., p. 94.
- “Misjudgment of the floor surface occurs frequently with patterned carpeting or the shadowing or pooling that occurs in solid-color carpeting. People with visual problems may be unable to identify real level changes from the appearance of changes in the pattern of the flooring. Other carpet patterns create a sensation of movement.” Baldrice, Nancy, Creating the Accessible Home: Updating Your Home for Changing Physical Needs, Creative Publishing International, Inc., p. 94.
- “Area rugs should not be used, but if they are they should adhere firmly to the floor, with no loose edges. Area rugs should be a color that contrasts strongly with the color of the floor.” Baldrice, Nancy, Creating the Accessible Home: Updating Your Home for Changing Physical Needs, Creative Publishing International, Inc., p. 94.
- “Add a contrasting border around the room’s edge to help people with vision problems mark room boundaries.” Baldrice, Nancy, Creating the Accessible Home: Updating Your Home for Changing Physical Needs, Creative Publishing International, Inc., p. 80.
- “Requirements by the Americans with Disabilities Act (ADA) allow carpet having a pile height of half an inch or less (measured from the bottom of the tuft). Exposed edges should be fastened to floor surfaces with trim along that edge. Carpet with a pile height, or any other floor covering, over a half inch must have a transition ramp between the surfaces.”  
[www.carpet-rug.org/commercial-customers/specification-and-intallation/ada-compliance.cfm](http://www.carpet-rug.org/commercial-customers/specification-and-intallation/ada-compliance.cfm)

### 901 Opt. 3 Slip Prevention Paint Or Traction Strips.

- “Non slip flooring should be used in the bathroom. The coefficient of friction (COF) is the amount of grip or resistance to slipping of a surface; the higher the number, the less slippery the surface. The researchers at Penn State estimated that 88% of the population would be ‘protected’ by a coefficient of friction of .6 for flat surfaces and .8 (1:12 grade).” Wylde, Margaret A., Building for a Lifetime: The Design and Construction of Fully Accessible Homes, Tauton Press, Inc., 184.
- “Many new ceramic tiles, vinyl and rubber-base linoleum have significantly improved slip resistance. Some nonglazed ceramic tiles have coefficients of friction as high as .8 and .9.  
These tiles are designed for use in wet areas, thus they are likely to maintain fairly good grip even when wet.” Wylde, Margaret A., Building for a Lifetime: The Design and Construction of Fully Accessible Homes, Tauton Press, Inc., 185.
- “Linoleum products have a greater degree of resistance than tiles and may help prevent injury in the event of a slip or fall in the bathroom.” Wylde, Margaret A., Building for a Lifetime: The Design and Construction of Fully Accessible Homes, Tauton Press, Inc., 186.
- “Use traction paint or adhesive traction strips to prevent slipping in areas that might get wet (e.g. the garage).” Baldrice, Nancy, Creating the Accessible Home: Updating Your Home for Changing Physical Needs, Creative Publishing International, Inc., p. 100.
- “Many joints on a ceramic floor tile reduce slippage.” Koehler’s Universal Design brochure.

### 901 Opt. 4 Color Contrast.

Contrasting colored borders help those with visual problems to identify real level changes in the flooring, otherwise solid-color carpeting or patterned carpeting can give the sensation of movement or a level change.

## Chapter 10. Windows

### 1001 Windows

#### General Information:

Keeping clear floor space in front of the window allows easy access to window hardware and curtain or drapery hardware. It also allows sufficient space for an emergency exit.

#### 1001 Opt. 1 Operable Components.

- Lower windows allow a seated person to see outside.
- Consider automated window openers especially for hard to reach windows.
- Operable parts within 20" to 48" above the floor are the best location for easy reach and operation.
- “Tilt-in windows are easy for cleaning both sides, but be cautious about the operable parts location.” Baldrice, Nancy, Creating the Accessible Home: Updating Your Home for Changing Physical Needs, Creative Publishing International, Inc.



### **1001 Opt. 2 Window Hardware.**

- “Casement windows are easy to operate, and they provide excellent safety exits for bedrooms and basements. Look for models that feature single-lever locking systems that are located close to the sill. For added convenience, consider adding an automatic window opener.” Baldrice, Nancy, Creating the Accessible Home: Updating Your Home for Changing Physical Needs, Creative Publishing International, Inc., p. 17.

### **1001 Opt. 4 Automated Window Coverings.**

Many automated window covering styles are available. They are especially convenient for hard to reach windows and easy to use by anyone.

## Chapter 11. Lighting

### 1101 Lighting

#### **General Information:**

- “Adequate lighting becomes increasingly important as we become older, and houses should be designed to provide ample amounts of natural and artificial lighting for everyone.” Wylde, Margaret A., Building for a Lifetime: The Design and Construction of Fully Accessible Homes, Tauton Press, Inc., p. 85.
- “The use of natural lighting affects the aesthetics, work efficiency, health, safety and economics of the home.” Wylde, Margaret A., Building for a Lifetime: The Design and Construction of Fully Accessible Homes, Tauton Press, Inc., p. 85.
- “Recently, compact fluorescent bulbs have become developed that fit into the standard table lamp and offer a full-spectrum of lighting.” Wylde, Margaret A., Building for a Lifetime: The Design and Construction of Fully Accessible Homes, Tauton Press, Inc., p. 86.
- “Plan lighting so that it will be bright and evenly distributed throughout the room, without shadows. Lighting that appears too bright for the young eye may be just right for the older eye, and the level can be controlled with a dimmer switch. All light sources should be shaded or diffused so no one has to look directly into the light source.” Wylde, Margaret A., Building For A Lifetime: The design and construction of fully accessible homes, Tauton Press, Inc., p. 86.
- “General room lighting is best provided through centrally located ceiling fixtures. Wall-mounted fixtures may be used to illuminate an area of the room, to provide task lighting or for decoration, but they generally do not distribute light evenly enough to serve as the sole light source. Ceiling fixtures that direct the light downward through translucent glass as well as upward to reflect off the ceiling are the best light sources.” Wylde, Margaret A., Building for a Lifetime: The Design and Construction of Fully Accessible Homes, Tauton Press, Inc., p. 87.
- “Select light fixtures whose bulbs can be changed easily and effortlessly” Wylde, Margaret A., Building for a Lifetime: The Design and Construction of Fully Accessible Homes, Tauton Press, Inc., p. 87.

### **1101 Opt. 1 Exterior Lighting.**

- “Install floodlights to illuminate patio areas, and overhead lighting to eliminate glare, use spotlight to light up keyholes, and add landscape lighting near walkways, decks, and patios to prevent falls and help people with vision problems mark boundaries.” Baldrice, Nancy, Creating the Accessible Home: Updating Your Home for Changing Physical Needs, Creative Publishing International, Inc., p. 115.
- “Automatic sensor lighting provides convenience and security for people with limited memory, vision, or mobility. Fit fixtures with long-life light bulbs to reduce bulb replacement for people with mobility problems, and choose full-spectrum bulbs to enhance visibility for people with limited vision.” Baldrice, Nancy, Creating the Accessible Home: Updating Your Home for Changing Physical Needs, Creative Publishing International, Inc., p. 115.

### **1101 Opt. 2 Built-In Task Lighting.**

- “Task lighting should be provided by built-in fixtures or by tabletop or floor lamps.” Wylde, Margaret A., Building for a Lifetime: The Design and Construction of Fully Accessible Homes, Tauton Press, Inc., p. 87.
- “Built-in light fixtures should hold more than one light bulb, so that if one burns out there is still a light source. Fixtures should allow for bulbs to be changed easily.” Wylde, Margaret A., Building for a Lifetime: The Design and Construction of Fully Accessible Homes, Tauton Press, Inc., p. 87.

## **Chapter 12. Lighting controls, Electrical Switches, and Outlets**

### **1201 Lighting Controls, Electrical Switches, and Outlets**

#### **1201.1 Electrical Panel Box.**

Be sure to install enough circuit breakers for the accessible bedroom. Additional technology and equipment, such as computers and possible medical equipment, require more outlets.

#### **1201 Opt. 2 Outlets 18"–24" High.**

18"–24" height outlets allow both seated and standing persons to comfortably reach an outlet.

#### **1201 Opt. 3 48" Max. Switch Height.**

- 48" maximum height allows either a seated or standing person to comfortably reach the switch. Children can also independently operate switches at this height.
- Switches for security systems, underground sprinkling systems should be easy to reach and on an accessible route.
- Outdoor outlets that can be turned on and off from inside the home are convenient for holiday lighting.

#### **1201 Opt. 4 Rocker Switches.**

All people can easily operate this type of switch. Finger movement is not required.

### **1201 Opt. 8 Motion Activated Lights Or Motion Detectors.**

Sensor and motion detectors are ideal for safety, particularly in the bathroom and at an accessible exterior entrance.

## **Chapter 13. Heating, Ventilation and Air Conditioning**

### **1301 Heating, Ventilation and Air Conditioning (HVAC)**

#### **General Information:**

- “A zoned system allows for separate control over various portions of the house, which can significantly reduce energy needs.” Wylde, Margaret A., Building for a Lifetime: The Design and Construction of Fully Accessible Homes, Tauton Press, Inc., p. 87.
- “The thermostat should be placed where it will not be affected by direct sunlight, but where there is a natural or artificial light source providing ample illumination of the control. The thermostat should be selected with ease of use and convenience in mind. Many thermostats on the market are almost impossible to read for the healthy, normal eye.” Wylde, Margaret A., Building for a Lifetime: The Design and Construction of Fully Accessible Homes, Tauton Press, Inc., p. 88.
- The thermostat measures the temperature of the air at the location height of the thermostat. Placing the thermostat at a height of 48" may be more comfortable for homeowners at a seated height.
- “The best choice for a heating, ventilation and cooling system for the lifespan house is an efficient unit, installed in an accessible location, which requires a minimal amount of monitoring and maintenance.” Wylde, Margaret A., Building for a Lifetime: The Design and Construction of Fully Accessible Homes, Tauton Press, Inc., p. 88.

#### **1301 Opt. 1 Furnace on Main Floor.**

“Install the HVAC unit in an area away from the quiet areas of the home (bedroom, dining room) and acoustically treat the walls around it.” Wylde, Margaret A., Building for a Lifetime: The Design and Construction of Fully Accessible Homes, Tauton Press, Inc., p. 89.

#### **1301 Opt. 2 Furnace Clear Floor Space.**

“Gas shut-off valves should be accessible to someone who uses a wheelchair or who has difficulty walking. Valves or other controls should be easy to operate by someone who has difficulty grasping and should not require tools that may not be available when need the most.” Wylde, Margaret A., Building for a Lifetime: The Design and Construction of Fully Accessible Homes, Tauton Press, Inc., p. 89.

### **1301 Opt. 3 53" Maximum Thermostat Height.**

- “The thermostat should be located in the room that is used the most, unless that room has another source of heat, such as a fireplace. It should be placed at a height comparable to a seated height for an individual, within the optimal reach zone (20" to 44" off the floor).”  
...“A height of 44" would be accessible to all.” Wylde, Margaret A., Building for a Lifetime: The Design and Construction of Fully Accessible Homes, Tauton Press, Inc., p. 87.

### **1301 Opt. 4 Programmable Thermostat.**

A programmable thermostat is energy efficient. A home can be kept at a desired temperature without continuous manual operation. It is also ideal for someone who may be physically unable to access the controls.

### **1301 Opt. 6 Remote Controls.**

Remote controls allow easy access from a distance for any user.

## **Chapter 14. Technology and Automation In The Home**

### **1401 Technology and Automation In The Home**

#### **General Information:**

“For people with mobility or hearing problems, install a phone jack on the deck or patio—or keep a cordless or cell phone handy—so family members can answer calls easily. Wire the doorbell to right on outside patios and decks.” Baldrice, Nancy, Creating the Accessible Home: Updating Your Home for Changing Physical Needs, Creative Publishing International, Inc., p. 115.

“As a precaution, install a telephone and intercom in the garage or utility room so disabled family members can answer calls and communicate with other family members in case of emergency.” Baldrice, Nancy, Creating the Accessible Home: Updating Your Home for Changing Physical Needs, Creative Publishing International, Inc., p. 99.

#### **1401 Opt. 3 Visible & Audible Alarms.**

Visible and audible alarms are ideal for those with hearing or vision impairments. Vibrating smoke detector alerts can be placed in bed, under a pillow.

#### **1401 Opt. 6 Security/Surveillance System.**

“Keyless entry systems provide home security with a custom code or remote, rather than a key, which makes them a good choice for people with limited hand strength.” Baldrice, Nancy, Creating the Accessible Home: Updating Your Home for Changing Physical Needs, Creative Publishing International, Inc., p. 106.

It is possible to use temporary codes for housekeepers, repair services, pet sitters, and anyone else who might need to get in when you are not home. The temporary access code can be easily erased when no longer needed.

#### **1401 Opt. 8 Intercom System.**

“For maximum performance, consider a home network system that brings all the office electrical systems together in one location. A hub—or distribution center—is typically mounted in a basement or a utility closet to receive phone, internet, cable or satellite TV lines, as well as stereo and video connections from an entertainment center in the home. Be sure to check with your local building department about codes for home network wiring.” Baldrice, Nancy, Creating the Accessible Home: Updating Your Home for Changing Physical Needs, Creative Publishing International, Inc., p. 90.

#### **1401 Opt. 17 Internet Connections.**

- “If you are working at home temporarily, stay in touch with coworkers and friends with a simple Internet and e-mail connection. Computer systems devoted entirely to these functions are available from most computer manufacturers.” Baldrice, Nancy, Creating the Accessible Home: Updating Your Home for Changing Physical Needs, Creative Publishing International, Inc., p. 90.
- “When your home office space serves as a primary or secondary work space, install a video jack (F-connector) to provide connections for receiving and redistributing TV, VCR, DVD, and closed-circuit camera signals. A universal remote will make using all your equipment easier.” Baldrice, Nancy, Creating the Accessible Home: Updating Your Home for Changing Physical Needs, Creative Publishing International, Inc., p. 90.
- “Your home office wiring also should include at least one voice/data (RJ45) jack for phone and data lines, as well as multi-line computer data connections.” Baldrice, Nancy, Creating the Accessible Home: Updating Your Home for Changing Physical Needs, Creative Publishing International, Inc., p. 90.

# ZeroStep Code Comparisons



## Chapter 1. Exterior Accessible Routes and Spaces

### 101 Components of an Accessible Route and Accessible Home Design

**Accessible routes and entrances shall consist of the following components, if applicable, and shall comply with the appropriate sections of the ZeroStep Guidelines:**

- There shall be one accessible parking space on an accessible route to a zero-step entrance, in accordance with [Section 102](#).
- There is at least two zero-step exterior entrances on an accessible route to the home, in accordance with [Section 201](#); and there shall be no steps between an interior landing and the main level of the house, in accordance with [Section 201.4](#).
- Walking surfaces are not steeper than 1:20 (5%) in accordance with [Section 104](#).
- Turning spaces shall be a circular space with a 60" minimum diameter in accordance with [Sections 105, 301, 401, 501, 601, 701, and 801](#). (ANSI increasing to 67")
- Doors and doorways shall be 36" wide in accordance with [Section 201](#).
- Ramps have a slope not steeper than 1:12 (8%) in accordance with [Section 106](#).
- Elevators comply with the most recent ANSI A117.1 standard.
- Hallways are a minimum of 42" wide in accordance with [Section 202](#).
- Stairways are a minimum of 36" wide in accordance with [Section 203](#).
- Clear floor space shall be 48" x 48" at fixtures in accordance with [Sections 301, 501, 601, 701, 1201 and 1301](#).
- An accessible route shall connect the main floor bathroom, bedroom, kitchen, and living/family room.

**These requirements are derived from the most recent edition of The ANSI Building Codes, The Fair Housing Guidelines, The Michigan Building Codes and The Michigan Residential Codes. As these codes are updated, so too will the ZeroStep™ Guidelines.**

**The next edition of the ANSI Reference Codes is planned to increase the clear turning space from 60-inches to 67-inches. The clear floor spaces are also planned to be increased from 48-inches by 48-Inches to 52-inches by 52-inches.**

**When the new editions are released, the ZeroStep™ Guidelines will be revised. Disability Advocates of Kent County recommends that these changes be considered in current construction design.**

**Accessible home design shall consist of all of the following components and shall comply with the applicable sections of the ZeroStep Guidelines:**

- There is at least one accessible *full* size bathroom on the main floor, in accordance with [Section 301](#).
- There is at least one accessible bedroom on the main floor, near an accessible bathroom, in accordance with [Section 401](#).
- There is at least one accessible closet in accordance with [Section 501](#).
- There is at least one accessible kitchen on the main floor in accordance with [Section 601](#).
- There is an accessible laundry area in accordance with [Section 701](#).
- There is at least one accessible living/family room on the main floor in accordance with [Section 801](#).
- Exterior lighting is provided in accordance with [Section 1101](#).
- The electrical panel box is accessible in accordance with [Section 1201](#).
- The thermostat is accessible in accordance with [Section 1301](#).

## 102 Parking and Driveways

**The contents of this section define what a ZeroStep™ parking space and driveway is. Following each ZeroStep™ guidelines section are provided references to the most recent edition of The ANSI Reference Codes, The Fair Housing Guidelines, The Michigan Building Codes, and The Michigan Residential Codes, from which the measures and dimensions requirements were derived and expanded upon.**

**102.1 Parking and Driveways.** There shall be one accessible parking space on an accessible route to a zero-step entrance. That portion of the driveway that may serve as the accessible parking area shall have a maximum slope of 1:48 (2%) in all directions. That portion of the driveway that is part of any accessible route on the site shall have a maximum cross slope of 1:48 (2%) and a maximum running slope of 1:20 (5%)

**ANSI A117.1 – 2009**  
**502 Parking Spaces**

**502.2 Vehicle Space Size.** Car parking spaces shall be 96 inches (2440 mm) minimum in width. Van parking spaces shall be 132 inches (3350 mm) minimum in width.

**EXCEPTION:** Van parking spaces shall be permitted to be 96 inches (2440 mm) minimum in width where the adjacent access aisle is 96 inches (2440 mm) minimum in width.

**502.5 Floor surfaces.** Parking spaces and access aisles shall comply with Section 302 (see [302.1](#) and [302.3](#)) and have surface slopes not steeper than 1:48. Access aisles shall be at the same level as the parking spaces they serve.

**502.8 Relationship to Accessible Routes.** Parking spaces and access aisles shall be designed so that cars and vans, when parked, cannot obstruct the required clear width of adjacent accessible routes.

**ANSI A117.1 – 2009**

**1002 Accessible Units** *(Nothing on Parking and Driveways)*

**ANSI A117.1 – 2009**

**1003 Type A Units** *(Nothing on Parking and Driveways)*

**ANSI A117.1 – 2009**

**1004 Type B Units** *(Nothing on Parking and Driveways)*

#### **Fair Housing Accessibility Guidelines**

**Section 100.205(a).** Covered multifamily dwellings for first occupancy after March 13, 1991 shall be designed and constructed to have at least one building entrance on an accessible route unless it is impractical to do so because of the terrain or unusual characteristics of the site.

**Section 100.205(a)(5) Accessible route.** An accessible route that complies with ANSI 4.3 would meet section 100.205 (a). If the slope of the finished grade between covered multifamily dwellings and a public or common use facility (including parking) exceeds 8.33%, or where other physical barriers (natural or manmade) or legal restrictions, all of which are outside the control of the owner, prevent the installation of an accessible pedestrian route, an acceptable alternative is to provide access via a vehicular route, so long as necessary site provisions such as parking spaces and curb ramps are provided at the public or common use facility.

**2012 MI Building Code**

**1106 Parking and Passenger Loading Facilities**

**1106.6 Location.** Accessible parking spaces shall be located on the shortest accessible route of travel from adjacent parking to an accessible building entrance.

**2015 MI Residential Code** *(Nothing on Parking and Driveways).*

**These requirements are derived from the most recent edition of The ANSI Reference Codes, The Fair Housing Guidelines, The Michigan Building Codes and The Michigan Residential Codes. As these codes are updated, so too will the ZeroStep™ Guidelines.**

## 103 Garage

**The contents of this section define what a ZeroStep™ garage is. Following each ZeroStep™ guidelines section are provided references to the most recent edition of The ANSI Reference Codes, The Fair Housing Guidelines, The Michigan Building Codes, and The Michigan Residential Codes, from which the measures and dimensions requirements were derived and expanded upon.**

**103.1 Garage Minimum Measurements - One Stall.** A one stall garage has a minimum of 16' clear width, 24' minimum depth. There is a minimum of 5' width access aisle located on an

8/8/2016 10:04:11 AM

[www.zerostep.org](http://www.zerostep.org)



accessible route into the home. There is a minimum of a 3' width access aisle on the opposite side of the vehicle.

**103.3 Garage Minimum Measurements - Two Stall.** A two stall garage has a minimum of 27' clear width, 24' minimum depth. There is a minimum of a 5' width access aisle located on an accessible route into the home. There is a minimum if a 3' width access aisle on the opposite side of the vehicle.

**ANSI A117.1 – 2009**

**1002 Accessible Units** (*Nothing on Garage*)

**ANSI A117.1 – 2009**

**1003 Type A Units** (*Nothing on Garage*)

**ANSI A117.1 – 2003**

**1004 Type B Units** (*Nothing on Garage*)

**Fair Housing Accessibility Guidelines - 1994 Supplemental Notice**

**Section 2 Accessibility Guidelines**

#### **14. Parking Spaces and Garages**

**14c. Q.** If a project having covered multifamily dwellings provides parking garages where there are several individual garages grouped together either in a separate area of the building (such as at one end of the building, or in a detached building), for assignment or rental to residents, are there any requirements for the inside dimensions of these individual parking garages?

**A.** Yes. These garages would be public and common use space, even though the individual garages may be assigned to a particular dwelling unit. Therefore, at least two-percent of the garages should be at least 14' 2" wide and the vehicular door should be at least 10'-0" wide.

**2012 MI Building Code** (*Nothing on Garage*)

**2015 MI Residential Code**

Section R309 - Garages and Carport

**R309.1 Floor Surface.** Garage floor surfaces shall be of *approved* noncombustible material.

The area of floor used for parking of automobiles or other vehicles shall be sloped to facilitate the movement of liquids to a drain or toward the main vehicle entry doorway.

**R309.2 Carports.** Carports shall be open on not less than two sides. Carport floor surfaces shall be of *approved* noncombustible material. Carports not open on two or more sides shall be considered a garage and shall comply with the provisions of this section for garages.

**EXCEPTION:** Asphalt surfaces shall be permitted at ground level in carports. The area of floor used for parking of automobiles or other vehicles shall be sloped to facilitate the movement of liquids to a drain or toward the main vehicle entry doorway.

**R309.3 Flood hazard areas.** For buildings located in flood hazard areas as established by Table R301.2 (1), garage floors

shall be:

1. Elevated to or above the design flood elevation as determined in Section R322; or
2. Located below the design flood elevation provided that the floors are at or above grade on not less than one side sides, are used solely for parking, building access, or storage, meet the requirements of Section R322, and are otherwise constructed in accordance with this code.

**R309.4 Automatic garage door openers.** Automatic garage door openers, if provided, shall be listed and labeled in accordance with UL 325.

**These requirements are derived from the most recent edition of The ANSI Reference Codes, The Fair Housing Guidelines, The Michigan Building Codes and The Michigan Residential Codes. As these codes are updated, so too will the ZeroStep™ Guidelines.**

## 104 Walks and Pathways

The contents of this section define what a ZeroStep™ walkway or pathway is. Following each ZeroStep™ guidelines section are provided references to the most recent edition of The ANSI Reference Codes, The Fair Housing Guidelines, The Michigan Building Codes, and The Michigan Residential Codes, from which the measures and dimensions requirements were derived and expanded upon.

**104.1 Slope.** A primary walk or pathway to a zero-step entrance shall not be steeper than 1:20 (5%). If the primary walk or pathway is greater than 1:20, see [Section 106 Ramps](#).

### ANSI A117.1 – 2009

#### 401 General

**401.1 Scope.** Accessible routes required by the scoping provisions adopted by the administrative authority shall comply with the applicable provisions of Chapter 4.

#### 402 Accessible Routes

**402.1 General.** Accessible routes shall comply with Section 402.

**402.2 Components.** Accessible routes shall consist of one or more of the following components: Walking surfaces with a slope not steeper than 1:20, doors, doorways, ramps, curb ramps excluding the flared sides, elevators and platform lifts. All components of an accessible route shall comply with the applicable portions of this standard.

#### 403 Walking Surfaces

**403.1 General.** Walking surfaces that are a part of an accessible route shall comply with Section 403.

**403.2 Floor surfaces.** Floor surfaces shall comply with Section 302. (See [302.1](#) and [302.3](#).)

**403.3 Slope.** The running slope of walking surfaces shall not be steeper than 1:20. The cross slope of a walking surface shall not be steeper than 1:48.

### ANSI A117.1 – 2009

8/8/2016 10:04:11 AM

[www.zerostep.org](http://www.zerostep.org)

## 1002 Accessible Units

**1002.4 Walking Surfaces.** Walking surfaces that are part of an accessible route shall comply with Section 403. (See [403.3](#).)

### ANSI A117.1 – 2009

#### 1003 Type A Units

**1003.4 Walking Surfaces.** Walking surfaces that are part of an accessible route shall comply with Section 403. (See [403.3](#).)

### ANSI A117.1 – 2009

#### 1004 Type B Units

**1004.3 Accessible Route.** Accessible routes within Type B units shall comply with Section 1004.3.

**1004.3.2 Components.** Accessible routes shall consist of one or more of the following elements: walking surfaces with a slope not steeper than 1:20, doors and doorways, ramps, elevators, and platform lifts.

## Fair Housing Accessibility Guidelines

See [Section 100.205\(a\)](#)

**Section 100.205(a)(1) Building Entrance.** Each building on a site shall have at least one building entrance on an accessible route unless prohibited by the terrain, as provided in paragraphs (2)(a)(i) or (2)(a)(ii), or unusual characteristics of the site, as provided in paragraph (2)(b). This guideline applies both to a single building on a site and to multiple buildings on a site.

**Section 100.205(a)(2)(a)(i).** Site impracticality due to terrain. There are two alternative tests for determining site impracticality due to terrain: the individual building test provided in paragraph (i), or the site analysis test provided in paragraph (ii). These tests may be used as follows.

**(i) Individual building test.** It is impractical to provide an accessible entrance served by an accessible route when the terrain of the site is such that:

**(A)** the slopes of the undisturbed site measured between the planned entrance and all vehicular or pedestrian arrival points within 50 feet of the planned entrance exceed 10 percent; and

**(B)** The sloped of the planned finished grade measured between the entrance and all vehicular or pedestrian arrival points within 50 feet of the planned entrance also exceed 10 percent.

If there are no vehicular or pedestrian arrival points within 50 feet of the planned entrance, the slope for the purposes of this paragraph (i) will be measured to the closest vehicular or pedestrian arrival point.

**(ii) Site analysis test.** Alternatively, for a site having multiple buildings, or a site with a single building with multiple entrances, impracticality of providing an accessible entrance served by an accessible route can be established by the following steps:

**(A)** The percentage of the total buildable area of the undisturbed site with a natural grade less than 10% slope shall

be calculated. The analysis of the existing slope (before grading) shall be done on a topographic survey with two foot (2') contour intervals with slope determination made between each successive interval. The accuracy of the slope analysis shall be certified by a professional licensed engineer, landscape architect or surveyor.

(B) To determine the practicality of providing accessibility to planned multi-family dwellings based on the topography of the existing natural terrain, the minimum percentage of ground floor units to be made accessible should equal the percentage of the total buildable area (not including floodplains, wetlands, or other restricted use areas) of the undisturbed site that has an existing natural grade of less than 10% slope.

(C) In addition to the percentage established in paragraph (B), all ground floor units in a building, or ground floor units served by a particular entrance, shall be made accessible if the entrance to the units to the units is on an accessible route, defined as a walkway with a slope between the planned entrance and a pedestrian or vehicular arrival point that is not greater than 8.33%.

See Section [100.205\(a\)\(5\)](#).

**2012 MI Building Code** (*Nothing on Walks and Pathways – Slope.*)

**2015 MI Residential Code**

**Section R311 Means of Egress**

**311.3.1 Floor elevations at the required egress doors.** Landings or floors at the required egress door shall not be more than 1 1/2 inches (38 mm) lower than the top of the threshold.

**EXCEPTION:** The exterior landing or floor shall not be more than 7 3/4 inches (196 mm) below the top of the threshold provided the door does not swing over the landing or floor.

Where exterior landings or floors serving the required egress door are not at grade, they shall be provided with access to grade by means of a ramp in accordance with Section R311.8 or a stairway in accordance with Section R311.7.

**Section 1010 Ramps**

**1010.3 Slope.** Ramps used as a part of a *means of egress* shall have a running slope not steeper than one unit vertical in 12 units horizontal (8-percent slope).

**1010.4 Cross Slope.** The slope measured perpendicular to the direction of travel of a ramp shall not be steeper than one unit vertical in 48 units horizontal (2-percent slope).

**104.2 Cross Slope.** The cross slope shall be a maximum of 1:48 (2%).

**ANSI A117.1 – 2009**

**1002 Accessible Units**

**1002.4 Walking Surfaces.** Walking surfaces that are part of an accessible route shall comply with Section 403. (See [403.3](#).)

**ANSI A117.1 – 2009**

**1003 Type A Units**

8/8/2016 10:04:11 AM

[www.zerostep.org](http://www.zerostep.org)

Appendix B: Code Comparisons 97

**1003.4 Walking Surfaces.** Walking surfaces that are part of an accessible route shall comply with Section 403. (See [403.3](#).)

**ANSI A117.1 – 2009**  
**1004 Type B Units**

**1004.4 Walking Surfaces.** *(Nothing on Walks and Pathways – Cross Slope.)*

**Fair Housing Accessibility Guidelines** *(Nothing on Walks and Pathways – Cross Slope.)*

**2012 MI Building Code** *(Nothing on Walks and Pathways – Cross Slope. See ANSI A117.1 Section 403 Accessible Routes.)*

**2015 MI Residential Code** *(Nothing on Walks and Pathways - Cross Slope)*

**104.3 Changes in Level.** Any change in level shall follow the following guidelines:

**104.3.1** Changes in level greater than ½" shall be beveled. (See Fig. 104.3 (a))

**104.3.2** Changes in level between ¼" high and ½" high maximum shall be beveled with a slope not steeper than 1:2 (50%). (See Fig. 104.3 (b))

**104.3.3** Changes in level of ¼" high shall be permitted to be vertical. (See Fig. 104.3 (c))

**ANSI A117.1 – 2009**  
**403 Walking Surfaces**

**403.4 Changes in Level.** Changes in level shall comply with Section 303. (See [303.1](#), [303.2](#) and [303.3](#).)

**303 Changes in Level**

**303.1 General.** Changes in level in floor surfaces shall comply with Section 303.

**303.2 Vertical.** Changes in level of ¼" (6.4mm) maximum in height shall be permitted to be vertical.

**303.3 Beveled.** Changes in level greater than ¼ inch (6.4 mm) in height and not more than ½ inch (13 mm) maximum in height shall be beveled with a slope not steeper than 1:2.

**303.4 Ramps.** Changes in level greater than ½ inch (13 mm) in height shall be ramped and shall comply with Section 405 or 406. (See [405.2](#) and [405.6](#).)

**ANSI A117.1 – 2009**  
**1002 Accessible Units**

**1002.4 Walking Surfaces.** Walking surfaces that are part of an accessible route shall comply with Section 403. (See [303.1](#), [303.2](#), and [303.3](#).)

**ANSI A117.1 – 2009**  
**1003 Type A Units**

**1003.4 Walking Surfaces.** Walking surfaces that are part of an accessible route shall comply with Section 403.

(See [303.1](#), [303.2](#), and [303.3](#).)

**ANSI A117.1 – 2009**

**1004 Type B Units**

**1004.4 Walking Surfaces.** Walking surfaces that are part of an accessible route shall comply with Section 1004.4.

(See [1004.4.2](#))

**Fair Housing Accessibility Guidelines**

**Section 100.205(a)(5).** Accessible route. An accessible route that complies with ANSI 4.3 (1986) would meet section 100.205(a). If the slope of the finished grade between covered multifamily dwellings and a public or common use facility (including parking) exceeds 8.33%, or where other physical barriers (natural or manmade) or legal restrictions, all of which are outside the control of the owner, prevent the installation of an accessible pedestrian route, and acceptable alternative is to provide access via a vehicular route, so long as necessary site provisions such as parking spaces and curb ramps are provided at the public or common use facility.

**2012 MI Building Code** (*Nothing on Walks and Pathways – Change in Level.*)

**2015 MI Residential Code** (Nothing on Walks and Pathways - Changes in Level.)

**104.4 Clear Width.** A walk and pathway on an accessible route shall have a clear minimum width of 36" maintained throughout.

**ANSI A117.1 – 2009**

**403 Walking Surfaces.**

**403.5 Clear Width.** The clear width of an accessible route shall be 36 inches (915 mm) minimum.

**EXCEPTION:** The clear width shall be permitted to be reduced to 32 inches (815 mm) minimum for a length of 24 inches (610 mm) maximum provided the reduced width segments are separated by segments that are 48 inches (1220 mm) minimum in length and 36 inches (915 mm) minimum in width.

**403.5.1 Clear Width at Turn.** Where an accessible route makes a 180 degree turn around an object that is less than 48 inches (1220 mm) in width, clear widths shall be 42 inches (1065 mm) minimum approaching the turn, 48 inches (1220 mm) minimum during the turn, and 42 inches (1065 mm) minimum leaving the turn.

**EXCEPTION:** Section 403.5.1 shall not apply where the clear width at the turn is 60 inches (1525 mm) minimum.

**ANSI A117.1 – 2009**

**1002 Accessible Units**

**1002.4 Walking Surfaces.** Walking surfaces that are part of an accessible route shall comply with Section 403. (See [403.5](#).)

**ANSI A117.1 – 2009**

**1003 Type A Units**

**1003.4 Walking Surfaces.** Walking surfaces that are part of an accessible route shall comply with Section 403. (See

403.5.)

**ANSI A117.1 – 2009**  
**1004 Type B Units**

**1004.4 Walking Surfaces.** Walking surfaces that are part of an accessible route shall comply with Section 1004.4.  
(See 1004.4.1.)

**Fair Housing Accessibility Guidelines**

See Section 100.205(a)(5).

**2012 MI Building Code** (*Nothing on Walks and Pathways – Clear Width.*)

**3104 Pedestrian Walkways and Tunnels**

**3104.8 Width.** The unobstructed width of pedestrian walkways shall not be less than 36 inches (914 mm). The total width shall not exceed 30 feet (9144mm).

**2015 MI Residential Code** (*Nothing on Walks and Pathways - Clear Width.*)

**These requirements are derived from the most recent edition of The ANSI Reference Codes, The Fair Housing Guidelines, The Michigan Building Codes and The Michigan Residential Codes. As these codes are updated, so too will the ZeroStep™ Guidelines.**

**The next edition of the ANSI Reference Codes is planned to increase the clear minimum wide of accessible routes from 36-inches to 48-inches. The Clear turning spaces are also planned to be increased from 60-inches in diameter to 67-inches in diameter. When the new editions are released, the ZeroStep™ Guidelines will be revised. Disability Advocates of Kent County recommends that these changes be considered in current construction design.**

## 105 Porches, Patios, Decks and Landings

The contents of this section define what a ZeroStep™ walkway or pathway is. Following each ZeroStep™ guidelines section are provided references to the most recent edition of The ANSI Reference Codes, The Fair Housing Guidelines, The Michigan Building Codes, and The Michigan Residential Codes, from which the measures and dimensions requirements were derived and expanded upon.

**105.1 Location.** Porches, patios, decks and exterior landings that are on the primary accessible entrance to the home shall comply with Section 201.2, 201.3 and 1101.1.

### ANSI A117.1 – 2009

#### 302 Floor Surfaces

**302.1 General.** Floor surface shall be stable, firm and slip resistant and shall comply with Section 302. Changes in level in floor surfaces shall comply with Section 303.

**302.2 Carpet.** Carpet or carpet tile shall be securely attached and shall have a firm cushion, pad, or backing or no cushion or pad. Carpet or carpet tile shall have a level loop, textured loop, level cut pile, or level cut/uncut pile texture. The pile shall be ½ inch (13 mm) maximum in height. Exposed edges of carpet shall be fastened to the floor and shall have trim along the entire length of the exposed edge. Carpet edge trim shall comply with Section 303. (See 303.1, 303.2, 303.3.)

**302.3 Openings.** Openings in floor surfaces shall be of a size that does not permit the passage of a ½ inch (13 mm) diameter sphere, except as allowed in Sections 407.4.3, 408.4.3, 409.4.3, 410.4, and 805.10. Elongated openings shall be placed so that the long dimension is perpendicular to the dominant direction of travel.

#### 304 Turning Space

**304.1 General.** A turning space shall comply with Section 304.

**304.2 Floor Surface.** Floor surfaces of a turning space shall comply with Section 302. Changes in level are not permitted within the turning space. (See 302.1, 302.2, and 302.3.)

**EXCEPTION:** Slopes not steeper than 1:48 shall be permitted.

**304.3 Size.** Turning spaces shall comply with Section 304.3.1 or 304.3.2.

**304.3.1 Circular Space.** The turning space shall be a circular space with a 60–inch (1525 mm) minimum diameter. The turning space shall be permitted to be knee and toe clearance complying with Section 306.

**304.3.2 T-Shaped Space.** The turning space shall be a T-shaped space within a 60–inch (1525 mm) minimum square, with arms and base 36 inches (915 mm) minimum in width. Each arm of the T shall be clear of obstructions 12 inches (305 mm) minimum in each direction, and the base shall be clear of obstructions 24 inches (610 mm) minimum. The turning space shall be permitted to be knee and toe clearance complying with Section 306. Only at the end of either the base or one arm.

**304.4 Door Swing.** Unless otherwise specified, doors shall be permitted to swing into turning spaces.

### ANSI A117.1 – 2009

8/8/2016 10:04:11 AM

[www.zerostep.org](http://www.zerostep.org)

Appendix B: Code Comparisons 101



## 1002 Accessible Units

**1002.3 Accessible Route.** Accessible routes within Accessible units shall comply with Section 1002.3.

**1002.3.1 Location.** At least one accessible route shall connect all spaces and elements that are a part of the unit. Accessible routes shall coincide with or be located in the same general circulation.

**EXCEPTION:** An accessible route is not required to unfinished attics and unfinished basements that are part of the unit.

**1002.3.2 Turning Space.** All rooms served by an accessible route shall provide a turning space complying with Section 304.

**EXCEPTION:**

1. A turning space shall not be required in toilet rooms and bathrooms that are not required to comply with Section 1002.11.2.
2. A turning space is not required within closets or pantries that are 48 Inches (1220 mm) maximum in depth.

**1002.3.3 Components.** Accessible routes shall consist of one or more of the following elements: walking surfaces with a slope not steeper than 1:20, doors and doorways, ramps, elevators, and platform lifts.

## ANSI A117.1 – 2009

### 1003 Type A Units

**1003.3 Accessible Route.** Accessible routes within Type A units shall comply with Section 1003.3.

**1003.3.1 Location.** At least one accessible route shall connect all spaces and elements that are a part of the unit. Accessible routes shall coincide with or be located in the same area as a general circulation path.

**EXCEPTION:** An accessible route is not required to unfinished attics and unfinished basements that are part of the unit.

**1003.3.2 Turning Space.** All rooms served by an accessible route shall provide a turning space complying with Section 304.

**EXCEPTIONS:**

1. A turning space is not required in toilet rooms and bathrooms that are not required to comply with Section 1003.11.2.
2. A turning space is not required within closets or pantries that are 48 inches (1220 mm) maximum in depth.

**1003.3.3 Components.** Accessible routes shall consist of one or more of the following elements: walking surfaces with a slope not steeper than 1:20, doors and doorways, ramps, elevators, and platform lifts.

## ANSI A117.1 – 2009

### 1004 Type B Units

**1004.3 Accessible Route.** Accessible routes within Type B units shall comply with Section 1004.3.

**1004.3.1 Location.** At least one accessible route shall connect all spaces and elements that are a part of the unit. Accessible routes shall coincide with or be located in the same area as a general circulation path.

**EXCEPTIONS:**

1. An accessible route is not required to unfinished attics and unfinished basements that are part of the unit.
2. One of the following is not required to be on an accessible route:
  - 2.1 A raised floor area in a portion of a living, dining, or sleeping room; or
  - 2.2 A sunken floor area in a portion of a living, dining, or sleeping room; or
  - 2.3 A mezzanine that does not have plumbing fixtures or an enclosed habitable space.

**1004.3.2 Components.** Accessible routes shall consist of one or more of the following elements: walking surfaces with a slope not steeper than 1:20, doors and doorways, ramps, elevators, and platform lifts.

**1004.4 Walking Surfaces.** Walking surfaces that are part of an accessible route shall comply with Section 1004.4.

**1004.4.1 Clear Width.** Clear width of an accessible route shall comply with Section [403.5](#).

**1004.4.2 Changes In Level.** Changes in level shall comply with Section 303. (See [303.1](#), [303.2](#), [303.3](#).)

**EXCEPTION:** Where exterior deck, patio or balcony surface materials are impervious, the finished exterior impervious surface shall be 4 inches (100 mm) maximum below the floor level of the adjacent interior spaces of the unit.

**Fair Housing Accessibility Guidelines**

**Section 100.205(3)(i).** Provides that all covered multifamily dwellings with a building entrance on an accessible route shall be designed and constructed in such a manner that all premises within covered multifamily dwelling units contain an accessible route into and through the covered dwelling unit.

**Section 100.205(3)(i)(1).** A minimum clear width of 36 inches is provided.

**Section 100.205(3)(i)(2).** In single-story dwelling units, changes in level within the dwelling unit with heights between ¼ inch and ½ inch are beveled with a slope no greater than 1:2. Except for design features, such as a loft or an area on a different level within a room (e.g. a sunken living room), changes in level greater than ½ inch are ramped or have other means of access. Where a single story dwelling unit has special design features, all portions of the single-story unit, except the loft or the sunken or raised area, are on an accessible route; and

(a) In single-story dwelling units with lofts, all spaces other than the loft are on an accessible route.

(b) Design features such as sunken or raised functional areas do not interrupt the accessible route through the remainder of the dwelling unit.

**Section 100.205(3)(i)(3).** In multi-story dwelling units in buildings with elevators, the story of the unit that is served by the building elevator (a) is the primary entry to the unit, (b) complies with Requirements 2 through 7 with respect to the rooms located on the entry/accessible floor; and (c) contains a bathroom or powder room. It complies with Requirement 7. (Note: multistory dwelling units in non-elevator buildings are not covered dwelling units. In such cases, there is no ground floor unit.)

**Section 100.205(3)(i)(4).** Except as provided in paragraphs (5) and (6) below, thresholds at exterior doors, including sliding door tracks, are no higher than ¾ inch. Thresholds and changes in level at these locations are beveled with a slope no greater than 1:2.

**Section 100.205(3)(i)(5).** Exterior deck, patio, or balcony surfaces are no more than ½ inch below the floor level of the interior of the dwelling unit, unless they are constructed of impervious material such as concrete, brick or flagstone. In

such case, the surface is no more than 4 inches below the floor level of the interior of the dwelling unit, or lower if required by local building code.

**Section 1002.205(3)(i)(6).** At the primary entry door to the dwelling units with direct exterior access, outside landing surfaces constructed of impervious materials such as concrete, brick or flagstone, are no more than ½ inch below the floor level of the interior of the dwelling unit. The finished surface of this area that is located immediately outside the entry may be sloped, up to 1/8 inch per foot (12 inches), for drainage.

#### 2012 MI Building Code

##### 1107 Dwelling Units and Sleeping Units

**1107.4 Accessible route.** At least one accessible route shall connect accessible building or facility entrances with the primary entrance of each Accessible unit, Type A unit and Type B unit within the building or facility and with those exterior and interior spaces and facilities that serve the units.

**EXCEPTION:**

1. If due to circumstances outside the control of the owner, either the slope of the finished ground level between accessible facilities and buildings exceeds one unit vertical in 12 units horizontal (1:12), or where physical barriers or legal restrictions prevent the installation of an accessible route, a vehicular route with parking that complies with Section 1106 at each public or common use facility or building is permitted in place of the accessible route.
2. Exterior decks, patios or balconies that are part of Type B units and have impervious surfaces, and that are not more than 4 inches (102 mm) below the finished floor level of the adjacent interior space of the unit.

#### 2015 MI Residential Code

##### Section R311 Means of Egress

**R311.3 Floors and landings at exterior doors.** There shall be a landing or floor on each side of each exterior door. The width of each landing shall not be less than the door served. Every landing shall have a minimum dimension of 36 inches (914 mm) measured in the direction of travel. Exterior landings shall be permitted to have a slope not to exceed 1/4 unit vertical in 12 units horizontal (2-percent).

**EXCEPTION:** Exterior balconies less than 60 square feet (5.6 mm) and only accessible from a door are permitted to have a landing less than 36 inches (914 mm) measured in the direction of travel.

**R311.3.1 Floor elevations at the required egress doors.** Landings or floors at the required egress door shall not be more than 1 1/2 inches (38 mm) lower than the top of the threshold.

**EXCEPTION:** The exterior landing or floor shall not be more than 7 3/4 inches (196 mm) below the top of the threshold provided the door does not swing over the landing or floor.

When exterior landings or floors serving the required egress door are not at grade, they shall be provided with access to grade by means of a ramp in accordance with Section R311.8 or a stairway in accordance with Section R311.7.

**105.2 Turning Space.** The porch shall have at least a 5' diameter turning space in front of the primary door opening.

**ANSI A117.1 – 2009  
1002 Accessible Units**

8/8/2016 10:04:11 AM

[www.zerostep.org](http://www.zerostep.org)

**1002.3 Accessible Route.** Accessible routes within Accessible units shall comply with Section 1002.3.

**1002.3.2 Turning Space.** All rooms served by an accessible route shall provide a turning space complying with Section 304.

**EXCEPTION:**

1. A turning space shall not be required in toilet rooms and bathrooms that are not required to comply with Section 1002.11.2.
2. A turning space is not required within closets or pantries that are 48 Inches (1220 mm) maximum in depth.

**ANSI A117.1 – 2009**

**1003 Type A Units**

**1003.3 Accessible Route.** Accessible routes within Type A units shall comply with Section 1003.3.

**1003.3.2 Turning Space.** All rooms served by an accessible route shall provide a turning space complying with Section 304.

**EXCEPTIONS:**

1. A turning space is not required in toilet rooms and bathrooms that are not required to comply with Section 1003.11.2.
2. A turning space is not required within closets or pantries that are 48 inches (1220 mm) maximum in depth.

**ANSI A117.1 – 2009**

**1004 Type B Units** (*Nothing on Porches, Patios, Decks and Landings – Turning Space.*)

**Fair Housing Accessibility Guidelines** (*Nothing on Porches, Patios, Decks and Landings – Turning Space.*)

**2012 MI Building Code**

**1008.1.6 Landings at doors.** Landings shall have a width not less than the width of the stairway or the door, whichever is greater. Doors in the fully open position shall not reduce a required dimension by more than 7 inches (178 mm). When a landing serves an occupant load of 50 or more, doors in any position shall not reduce the landing to less than one-half its required width. Landings shall have a length measured in the direction of travel of not less than 44 inches (1118 mm).

**EXCEPTION:** Landing length in the direction of travel in Group R-3 and U and within individual units of Group R-2 need not exceed 36 inches (914 mm).

**2009 MI Residential Code**

**R311.3 Floors and landings at exterior doors.** See ZS Section 105.1 Location, 2009 MI Residential Code. R311.3.

**2015 MI Residential Code**

**R311.3 Floors and landings at exterior doors.** There shall be a landing or floor on each side of each exterior door. The width of each landing shall not be less than the door served. Every landing shall have a minimum dimension of 36 inches (914 mm) measured in the direction of travel. Exterior landings shall be permitted to have a slope not to exceed 1/4 unit vertical in 12 units horizontal (2-percent).

**EXCEPTION:** Exterior balconies less than 60 square feet (5.6 m<sup>2</sup>) and only accessible from a door are

permitted to have a landing less than 36 inches (914 mm) measured in the direction of travel.

**R311.3.1 Floor elevations at the required egress doors.** Landings or floors at the required egress door shall not be more than 1 1/2 inches (38 mm) lower than the top of the threshold.

**EXCEPTION:** The exterior landing or floor shall not be more than 7 3/4 inches (196 mm) below the top of the threshold provided the door does not swing over the landing or floor.

When exterior landings or floors serving the required egress door are not at grade, they shall be provided with access to grade by means of a ramp in accordance with Section R311.8 or a stairway in accordance with Section R311.7.

**105.3 Changes in Level.** Porches, patios, decks and landings that are on an accessible route shall comply with Section 104 Walks and Pathways, 104.3.1 –104.3.3.

**ANSI A117.1 – 2009**

**403 Walking Surfaces**

**403.1 General.** Walking surfaces that are a part of an accessible route shall comply with Section 403.

**403.4 Changes in Level.** Changes in level shall comply with Section 303. (See 303.1, 303.2, 303.3.)

**ANSI A117.1 – 2009**

**1002 Accessible Units**

**1002.4 Walking Surfaces.** Walking surfaces that are part of an accessible route shall comply with Section 403. (See 403.4.)

**ANSI A117.1 – 2009**

**1003 Type A Units**

**1003.4 Walking Surfaces.** Walking surfaces that are part of an accessible route shall comply with Section 403. (See 403.4.)

**1004 Type B Units**

**1004.4 Walking Surfaces.** Walking surfaces that are part of an accessible route shall comply with Section 1004.4.

**1004.4.2 Changes in Level.** Changes in level shall comply with Section 303 (See 303.2 & 303.3.)

**EXCEPTION:** Where exterior deck, patio or balcony surface materials are impervious, the finished exterior impervious surface shall be 4 inches (100 mm) maximum below the floor level of the adjacent interior spaces of the unit.

**Fair Housing Accessibility Guidelines**

See Section 1002.205(c)(3)(i), Section 1002.205(c)(3)(ii)(2), Section 1002.205(c)(3)(ii)(4), Section 1002.205(c)(3)(ii)(5), and Section 1002.205(c)(3)(ii)(6).

## 2012 MI Building Code

### 1107 Dwelling Units and Sleeping Units

**1107.4 Accessible route.** At least one accessible route shall connect accessible building or facility entrances with the primary entrance of each Accessible unit, Type A unit and Type B unit within the building or facility and with those exterior and interior spaces and facilities that serve the units.

**EXCEPTION:**

1. If due to circumstances outside the control of the owner, either the slope of the finished ground level between accessible facilities and buildings exceeds one unit vertical in 12 units horizontal (1:12), or where physical barriers or legal restrictions prevent the installation of an accessible route, a vehicular route with parking that complies with Section 1106 at each public or common use facility or building is permitted in place of the accessible route.
2. Exterior decks, patios or balconies that are part of Type B units and have impervious surfaces, and that are not more than 4 inches (102 mm) below the finished floor level of the adjacent interior space of the unit.

## 2015 MI Residential Code

### Section R311 Means of Egress

**R311.3 Floors and landings at exterior doors.** Floors and landings at exterior doors. There shall be a landing or floor on each side of each exterior door. The width of each landing shall not be less than the door served. Every landing shall have a minimum dimension of 36 inches (914 mm) measured in the direction of travel. Exterior landings shall be permitted to have a slope not to exceed 1/4 unit vertical in 12 units horizontal (2-percent).

**EXCEPTION:** Exterior balconies less than 60 square feet (5.6 m<sup>2</sup>) and only accessible from a door are permitted to have a landing less than 36 inches (914 mm) measured in the direction of travel.

**R311.3.1 Floor elevations at the required egress doors.** Landings or floors at the required egress door shall not be more than 1 1/2 inches (38 mm) lower than the top of the threshold.

**EXCEPTION:** The exterior landing or floor shall not be more than 7 3/4 inches (196 mm) below the top of the threshold provided the door does not swing over the landing or floor.

When exterior landings or floors serving the required egress door are not at grade, they shall be provided with access to grade by means of a ramp in accordance with Section R311.8 or a stairway in accordance with Section R311.7.

**105.4 Openings.** Deck boards shall be spaced no more than ¼" apart.

## ANSI A117.1 – 2009

### 403 Walking Surfaces

**403.1 General.** Walking surfaces that are a part of an accessible route shall comply with Section 403.

**403.2 Floor Surface.** Floor surfaces shall comply with Section 302. (See [302.3](#).)

## ANSI A117.1 – 2009

### 1002 Accessible Units

8/8/2016 10:04:11 AM

[www.zerostep.org](http://www.zerostep.org)

Appendix B: Code Comparisons 107

**1002.4 Walking Surfaces.** Walking surfaces that are part of an accessible route shall comply with Section 403. (See [403.2.](#))

**ANSI A117.1 – 2009**

**1003 Type A Units**

**1003.4 Walking Surfaces.** Walking surfaces that are part of an accessible route shall comply with Section 403. (See [403.2.](#))

**ANSI A117.1- 2003**

**1004 Type B Units** *(Nothing on Porches, Patios, Decks and Landings – Openings.)*

**Fair Housing Accessibility Guidelines** *(Nothing on Porches, Patios, Decks and Landings – Openings.)*

**2012 MI Building Code** *(Nothing on Porches, Patios, Decks and Landings – Openings.)*

**2015 MI Residential Code** *(Nothing on Porches Patios, Decks and Landings – Openings.)*

**These requirements are derived from the most recent edition of The ANSI Reference Codes, The Fair Housing Guidelines, The Michigan Building Codes and The Michigan Residential Codes. As these codes are updated, so too will the ZeroStep™ Guidelines.**

**The next edition of the ANSI Reference Codes is planned to increase the clear minimum wide of accessible routes from 36-inches to 48-inches. The clear floor spaces are also planned to be increased from 48-inches by 48-inches to 52-inches by 52-inches. The clear turning spaces are also planned to be increased from 60-inches in diameter to 67-inches in diameter. When the new editions are released, the ZeroStep™ Guidelines will be revised. Disability Advocates of Kent County recommends that these changes be considered in current construction design.**

## 106 Ramps (See local codes first.)

The contents of this section define what a ZeroStep™ ramp is. Following each ZeroStep™ guidelines section are provided references to the most recent edition of The ANSI Reference Codes, The Fair Housing Guidelines, The Michigan Building Codes, and The Michigan Residential Codes, from which the measures and dimensions requirements were derived and expanded upon.

**106.1 When to Install a Ramp.** A ramp is installed when the walking slope is greater than 1:20 (5%).

**106.2 Slope.** The ramp slope shall not be steeper than 1:12 (8%).

### ANSI A117.1 – 2009

#### 405 Ramps

**405.1 General.** Ramps along accessible routes shall comply with Section 405 Ramps.

**405.2 Slope.** Ramp runs shall have a running slope greater than 1:20 and not steeper than 1:12.

**EXCEPTION:** In existing buildings or facilities, ramps shall be permitted to have slopes steeper than 1:12 complying with Table 405.2 where such slopes are necessary due to space limitations.

### ANSI A117.1 – 2009

#### 1002 Accessible Units

**1002.6 Ramps.** Shall comply with Section 405. (See [405.2](#).)

### ANSI A117.1 – 2009

#### 1003 Type A Units

**1003.6 Ramps.** Shall comply with Section 405. (See [405.2](#).)

### ANSI A117.1- 2003

#### 1004 Type B Units

**1004.6 Ramps.** Shall comply with Section 405. (See [405.2](#).)

### Fair Housing Accessibility Guidelines

(Refer to ANSI A117.1 – 1986, section 4.8 – Ramps: Accessible routes with slopes greater than 1:20.)

### 2009 MI Building Code

#### Section 1010 Ramps

**Section 1010.2 Slope.** Ramps used as part of a means of egress shall have a running slope not steeper than one unit vertical in 12 units horizontal (8 – percent slope). The slope of other pedestrian ramps shall not be steeper than one unit vertical in eight units horizontal (12.5-percent slope).



**EXCEPTION:** Aisle ramp slope in occupancies of Group A or assembly occupancies accessory to Group E occupancies shall comply with Section 1028.11.

**Section 1028.11 Assembly aisle walking surfaces.** Aisles with a slope not exceeding one unit vertical in eight units horizontal (12.5-percent slope) shall consist of a ramp having a slip-resistant walking surface. Aisles with slope exceeding one unit vertical in eight units horizontal (12.5-percent slope) shall consist of a series of risers and treads that extends across the full width of aisles and complies with Sections 1028.11.1 through 1028.11.3.

#### 2012 MI Building Code

##### Section 1010 Ramps

**Section 1010.3 Slope.** Ramps used as part of a means of egress shall have a running slope not steeper than one unit vertical in 12 units horizontal (8 – percent slope). The slope of other pedestrian ramps shall not be steeper than one unit vertical in eight units horizontal (12.5-percent slope).

**EXCEPTION:** Aisle ramp slope in occupancies of Group A or assembly occupancies accessory to Group E occupancies shall comply with Section 1028.11.

**Section 1028.11 Assembly aisle walking surfaces.** Aisles with a slope not exceeding one unit vertical in eight units horizontal (12.5-percent slope) shall consist of a ramp having a slip-resistant walking surface. Aisles with slope exceeding one unit vertical in eight units horizontal (12.5-percent slope) shall consist of a series of risers and treads that extends across the full width of aisles and complies with Sections 1028.11.1 through 1028.11.3.

#### 2015 MI Residential Code

##### R311.8 Ramps.

**R311.8.1 Maximum slope.** Ramps shall have a maximum slope of one unit vertical in 12 units horizontal (8.3 – percent slope). All other ramps shall have a maximum slope of 1 unit vertical in 8 units horizontal (12.5%).

**EXCEPTION:** Where it is technically infeasible to comply because of site constraints, ramps may have a maximum slope of one unit vertical in eight horizontal (12.5 percent slope).

**106.3 Cross Slope.** The cross slope shall be a maximum of 1:48 (2%) or less.

##### ANSI A117.1 – 2009 405 Ramps

**405.3 Cross Slope.** Cross slope of ramp runs shall not be steeper than 1:48.

##### ANSI A117.1 – 2009 1002 Accessible Units

**1002.6 Ramps.** Shall comply with Section 405. (See [405.3](#).)

##### ANSI A117.1 – 2009 1003 Type A Units

8/8/2016 10:04:11 AM

[www.zerostep.org](http://www.zerostep.org)

**1003.6 Ramps.** Shall comply with Section 405. (See [405.3](#))

**ANSI A117.1- 2003**

**1004 Type B Units**

**1004.6 Ramps.** Shall comply with Section 405. (See [405.3](#))

**Fair Housing Accessibility Guidelines**

(Refer to ANSI A117.1 – 1986, section 4.8 – Ramps.)

**2012 MI Building Code**

**Section 1010 Ramps**

**1010.4 Cross Slope.** The slope measured perpendicular to the direction of travel of a ramp shall not be steeper than one unit vertical in 48 units horizontal (2-percent slope).

**2015 MI Residential Code** (Nothing on Ramps - Cross Slope.)

**106.4 Clear Width.** The clear width of a ramp run shall be a minimum of 42" to a maximum of 48". Code allows a clear ramp width of 36" but this should be used in rare circumstance.

**ANSI A117.1 – 2009**

**405 Ramps**

**405.5 Clear Width.** The clear width of a ramp run shall be 36 inches (915 mm) minimum. Handrails and handrail supports that are provided on the ramp run shall not project into the required clear width of the ramp run.

**ANSI A117.1 – 2009**

**1002 Accessible Units**

**1002.6 Ramps.** Shall comply with Section 405. (See [405.5](#).)

**ANSI A117.1 – 2009**

**1003 Type A Units**

**1003.6 Ramps.** Shall comply with Section 405. (See [405.5](#).)

**ANSI A117.1- 2003**

**1004 Type B Units**

**1004.6 Ramps.** Shall comply with Section 405. (See [405.5](#).)

**Fair Housing Accessibility Guidelines**

(Refer to ANSI A117.1 – 1986, section 4.8 – Ramps.)

**2012 MI Building Code**

**Section 1010 Ramps**

**1010.6 Minimum dimensions.**

**1010.6.1 Width.** The minimum width of a means of egress ramp shall not be less than that required for corridors by Section 1018.2. The clear width of a ramp and the clear width between handrails, if provided, or other permissible projections shall be 36 inches (914 mm) minimum.

**2015 Residential Code** (*Nothing on Ramps and Clear Width*)

**106.5 Rise.** The rise shall be 30" maximum between landings, and preferably less.

**ANSI A117.1 – 2009**

**405 Ramps**

**405.6 Rise.** The rise for any ramp run shall be 30 inches (760 mm) maximum.

**ANSI A117.1 – 2009**

**1002 Accessible Units**

**1002.6 Ramps.** Shall comply with Section 405. (See [405.6](#).)

**ANSI A117.1 – 2009**

**1003 Type A Units**

**1003.6 Ramps.** Shall comply with Section 405. (See [405.6](#).)

**ANSI A117.1- 2003**

**1004 Type B Units**

**1004.6 Ramps.** Shall comply with Section 405. (See [405.6](#).)

**Fair Housing Accessibility Guidelines**

(Refer to ANSI A117.1 – 1986, section 4.8 – Ramps.)

**2012 MI Building Code**

**Section 1010 Ramp**

**1010.5 Vertical rise.** The rise for any ramp run shall be 30 inches (762 mm) maximum.

**2015 MI Residential Code** (*Nothing on Ramps - Rise*).

**106.6 Landings.** Ramps shall have landings at the bottom and top of each ramp run. The

8/8/2016 10:04:11 AM

[www.zerostep.org](http://www.zerostep.org)

landing at the bottom need not be the same material as the ramp run, however it must be a hard surface, e.g. concrete. A ramp run shall not exceed 30' maximum, preferably 24', in length between landings.

**ANSI A117.1 – 2009**

**405 Ramps**

**405.4 Floor Surfaces.** Floor surfaces of ramp runs shall comply with Section 302. (See [302.1](#), [302.2](#), and [302.3](#).)

**405.7 Landings.** Ramps shall have landings at bottom and top of each ramp run. Landings shall comply with Section 405.7.

**ANSI A117.1 – 2009**

**1002 Accessible Units**

**1002.6 Ramps.** Shall comply with Section **405 Ramps**. (See [405.7](#).)

**ANSI A117.1 – 2009**

**1003 Type A Units**

**1003.6 Ramps.** Shall comply with Section **405 Ramps**. (See [405.7](#).)

**ANSI A117.1- 2003**

**1004 Type B Units**

**1004.6 Ramps.** Shall comply with Section **405 Ramps**. (See [405.7](#).)

**Fair Housing Accessibility Guidelines**

(Refer to ANSI A117.1 – 1986, section 4.8 – Ramps.)

**2012 MI Building Code**

**Section 1010 Ramp**

**1010.7 Landings.** Ramps shall have landings at the bottom and top of each ramp, points of turning, entrance, exits and at doors. Landings shall comply with Sections 1010.7.1 through 1010.7.5.

**2015 MI Residential Code**

**R311.8 Ramps.**

**R311.8.2 Landings required.** There shall be a floor or landing at the top and bottom of each ramp, where doors open onto ramps, and where ramps change directions. The width of the landing perpendicular to the ramp slope shall be not less than 36 inches (914 mm).

**106.6.1 Landing Slope.** Landings shall slope 1:48 (2%) or less. Changes in level are not permitted.

**ANSI A117.1 – 2009**

8/8/2016 10:04:11 AM

[www.zerostep.org](http://www.zerostep.org)

## 405 Ramps

**405.7.1 Slope.** Landings shall have a slope not steeper than 1:48 and shall comply with Section 302.

### ANSI A117.1 – 2009

#### 1002 Accessible Units

**1002.6 Ramps.** Shall comply with Section 405. (See [405.7.1](#).)

### ANSI A117.1 – 2009

#### 1003 Type A Units

**1003.6 Ramps.** Shall comply with Section 405. (See [405.7.1](#).)

### ANSI A117.1- 2003

#### 1004 Type B Units

**1004.6 Ramps.** Shall comply with Section 405. (See [405.7.1](#).)

## Fair Housing Accessibility Guidelines

(Refer to ANSI A117.1 – 1986, section 4.8 – Ramps.)

## 2012 MI Building Code

### Section 1010 Ramp

**1010.7 Landings.** Ramps shall have landings at the bottom and top of each ramp, points of turning, entrance, exits and at doors. Landings shall comply with Sections 1010.7.1 through 1010.7.5.

1010.7.1 Slope. Landings shall have a slope not steeper than one unit vertical in 48 units horizontal (2-percent slope) in any direction. Changes in level are not permitted.

## 2015 Michigan Residential Code

### Section r311 Means of Egress

#### R311.8 Ramps.

**R311.8.1 Maximum slope.** Ramps shall have a maximum slope of one unit vertical in 12 units horizontal (8.3 – percent slope). All other ramps shall have a maximum slope of 1 unit vertical in 8 units horizontal (12.5%).

**EXCEPTION:** Where it is technically infeasible to comply because of site constraints, ramps may have a maximum slope of one unit vertical in eight horizontal (12.5 percent slope).

**106.6.2 Landing Clear Width.** Clear width of landings shall be at least as wide as the widest ramp run leading to the landing.

### ANSI A117.1 – 2009

8/8/2016 10:04:11 AM

[www.zerostep.org](http://www.zerostep.org)

#### 405 Ramps

**405.7.2 Width.** Clear width of landings shall be at least as wide as the widest ramp run leading to the landing.

#### ANSI A117.1 – 2009

##### 1002 Accessible Units

**1002.6 Ramps.** Shall comply with Section 405. (See [405.7.2](#).)

#### ANSI A117.1 – 2009

##### 1003 Type A Units

**1003.6 Ramps.** Shall comply with Section 405. (See [405.7.2](#).)

#### ANSI A117.1- 2003

##### 1004 Type B Units

**1004.6 Ramps.** Shall comply with Section 405. (See [405.7.2](#).)

#### Fair Housing Accessibility Guidelines

(Refer to ANSI A117.1 – 1986, section 4.8 – Ramps.)

#### 2012 MI Building Code

##### Section 1010 Ramp

**1010.7.2 Width.** The landing shall be at least as wide as the widest ramp run adjoining the landing.

#### 2015 MI Residential Code

##### R311.8 Ramps.

**R311.8.2 Landings required.** There shall be a floor or landing at the top and bottom of each ramp, where doors open onto ramps, and where ramps change directions. The width of the landing perpendicular to the ramp slope shall be not less than 36 inches (914 mm).

**106.6.3 Landing Length.** The landing length shall be 60" minimum.

#### ANSI A117.1 – 2009

##### 405 Ramps

**405.7.3 Length.** Landings shall have a clear length of 60 inches (1525 mm) minimum.

#### ANSI A117.1 – 2009

##### 1002 Accessible Units

**1002.6 Ramps.** Shall comply with Section 405. (See [405.7.3](#).)

#### ANSI A117.1 – 2009

8/8/2016 10:04:11 AM

[www.zerostep.org](http://www.zerostep.org)

### 1003 Type A Units

**1003.6 Ramps.** Shall comply with Section 405. (See [405.7.3](#).)

### ANSI A117.1- 2003

#### 1004 Type B Units

**1004.6 Ramps.** Shall comply with Section 405. (See [405.7.3](#).)

### Fair Housing Accessibility Guidelines

(Refer to ANSI A117.1 – 1986, section 4.8 – Ramp.)

### 2012 MI Building Code

#### Section 1010 Ramp

**1010.7.3 Length.** The landing length shall be 60 inches (1525 mm) minimum.

**EXCEPTION:**

1. In Group R-2 and R-3 individual dwelling and sleeping units that are not required to be Accessible units, Type A units or Type B units in accordance with Section 1107, landings are permitted to be 36 inches (914 mm) minimum.
2. Where the ramp is not part of an accessible route, the length of the landing shall not be required to be more than 48 inches (1220 mm) in the direction of travel.

### 2015 MI Residential Code

#### R311.8 Ramps.

**R311.8.2 Landings required.** There shall be a floor or landing at the top and bottom of each ramp, where doors open onto ramps, and where ramps change directions. The width of the landing perpendicular to the ramp slope shall be not less than 36 inches (914 mm).

**106.6.4 Landing Change in Direction - 90° Turn.** A ramp that makes a 90° turn shall have a minimum 5' x 5' landing.

### ANSI A117.1 – 2009

#### 405 Ramps

**405.7.4 Change in Direction.** Ramps that change direction at ramp landings shall be sized to provide a turning space complying with Section 304 (See [304.3](#), [304.3.1](#) & [304.3.2](#)).

### ANSI A117.1 – 2009

#### 1002 Accessible Units

**1002.6 Ramps.** Shall comply with Section 405. (See [405.7.4](#).)

### ANSI A117.1 – 2009

#### 1003 Type A Units

8/8/2016 10:04:11 AM

[www.zerostep.org](http://www.zerostep.org)

**1003.6 Ramps.** Shall comply with Section 405. (See [405.7.4](#).)

**ANSI A117.1- 2003**

**1004 Type B Units**

**1004.6 Ramps.** Shall comply with Section 405. (See [405.7.4](#).)

**Fair Housing Accessibility Guidelines**

(Refer to ANSI A117.1 – 1986, section 4.8 – Ramps.)

**2012 MI Building Code**

**Section 1010 Ramps**

**1010.7 Landings.**

**1010.6.4 Change in direction.** Where changes in direction of travel occur at landings provided between ramp runs, the landing shall be 60 inches by 60 inches (1524 mm by 1524 mm) minimum.

***EXCEPTION:*** In Group R-2 and R-3 individual dwelling or sleeping units that are not required to be Accessible units, Type A units or Type B units in accordance with Section 1107, landings are permitted to be 36 inches by 36 inches (914 mm by 914 mm) minimum.

**Section 101 General**

**101.2 Scope.** The provisions of this code shall apply to the construction, alteration, movement enlargement, replacement, repair, equipment, use and occupancy, location, maintenance, removal and demolition of every building or structure or any appurtenances connected or attached to such buildings or structures.

***EXCEPTION:***

1. Detached one-and two-family dwellings and multiple single-family dwellings (town houses) not more than three stories above grade plane in height with a separate means of egress and their accessory structures shall comply with the International Residential Code.
2. Existing buildings undergoing repair, alterations or additions and change of occupancy shall be permitted to comply with the International Existing Building Code.

**2015 MI Residential Code**

**R311.8 Ramps.**

**R311.8.2 Landings required.** There shall be a floor or landing at the top and bottom of each ramp, where doors open onto ramps, and where ramps change directions. The width of the landing perpendicular to the ramp slope shall be not less than 36 inches (914 mm).

**106.6.5 Landing Change in Direction - 180° Turn.** A ramp that makes a 180° turn shall have a minimum 7' length which is equal to the sum of the ramp widths plus space between ramps, if any, by 5' landing width.

**ANSI A117.1 – 2009**

8/8/2016 10:04:11 AM

[www.zerostep.org](http://www.zerostep.org)



**304 Turning Space** (See [304.1](#), [304.3](#), [304.3.1](#), and [304.3.2](#).)

**ANSI A117.1 – 2009**

**1002 Accessible Units**

**1002.6 Ramps.** Ramps shall comply with Section 405. (See [405.7.4](#).)

**ANSI A117.1 – 2009**

**1003 Type A Units**

**1003.6 Ramps.** Ramps shall comply with Section 405. (See [405.7.4](#).)

**ANSI A117.1 – 2009**

**1004 Type B Units**

**1004.6 Ramps.** Ramps shall comply with Section 405. (See [405.7.4](#).)

**Fair Housing Accessibility Guidelines**

(Refer to ANSI A117.1 – 1986, section 4.8 – Ramps.)

**2012 MI Building Code**

(See Section [1010.7 Landings](#), and [1010.7.4 Change in direction](#).)

**2015 MI Residential Code**

**R311.8 Ramps.**

**R311.8.2 Landings required.** There shall be a floor or landing at the top and bottom of each ramp, where doors open onto ramps, and where ramps change directions. The width of the landing perpendicular to the ramp slope shall be not less than 36 inches (914 mm).

**106.6.6 Landings for a Child.** Due to personal needs for a child, a home owner may customize the landing.

**ANSI A117.1 – 2009**

**1002 Accessible Units** (*Nothing on Ramps – Landings for a Child.*)

**ANSI A117.1 – 2009**

**1003 Type A Units** (*Nothing on Ramps – Landings for a Child.*)

**ANSI A117.1 – 2009**

**1004 Type B Units** (*Nothing on Ramps – Landings for a Child.*)

**Fair Housing Accessibility Guidelines** (*Nothing on Ramps – Landings for a Child.*)

**2009 MI Building Code** (*Nothing on Ramps – Landings for a Child.*)

**2009 MI Residential Code** (*Nothing on Ramps – Landings for a Child.*)

8/8/2016 10:04:11 AM

[www.zerostep.org](http://www.zerostep.org)

Appendix B: Code Comparisons 118

**106.7 Edge Protection.** Edge protection shall comply with Section 1010.10.1 or 1010.10.2 of the Michigan Building Code.

**ANSI A117.1 – 2009**

**405 Ramps**

**405.9 Edge Protection.** Edge protection complying with Section 405.9.1 or 405.9.2 shall be provided on each side of ramp runs and at each side of ramp landings.

**EXCEPTIONS:**

1. Edge protection shall not be required on ramps not required to have handrails and that have flared sides complying with Section 406.3.
2. Edge protection shall not be required on the sides of ramp landings serving an adjoining ramp run or stairway.
3. Edge protection shall not be required on the sides of ramp landings having a vertical drop-off of  $\frac{1}{2}$  inch (13 mm) maximum within 10 inches (255 mm) horizontally of the minimum landing area specified in Section 405.7.
4. Edge protection shall not be required on the sides of ramped aisles where the ramps provide access to the adjacent seats and aisle access ways.

**405.9.1 Extended Floor Surface.** The floor surface of the ramp run or ramp landing shall extend 12 inches (305 mm) minimum beyond the inside face of a railing complying with Section 505. (See [505.10.](#))

**405.9.2 Curb or Barrier.** A curb complying with Section 405.9.2.1 or a barrier complying with Section 405.9.2.2 shall be provided.

**405.9.2.1 Curb.** A curb shall be a minimum of 4 inches (100 mm) in height.

**405.9.2.2 Barrier.** Barriers shall be constructed so that the barrier prevents the passage of a 4-inch (100 mm) diameter sphere where any portion of the sphere is within 4 inches (100 mm) of the floor.

**ANSI A117.1 – 2009**

**1002 Accessible Units**

**1002.6 Ramps.** Shall comply with Section 405. (See [405.9.](#))

**ANSI A117.1 – 2009**

**1003 Type A Units**

**1003.6 Ramps.** Shall comply with Section 405. (See [405.9.](#))

**ANSI A117.1- 2003**

**1004 Type B Units**

**1004.6 Ramps.** Shall comply with Section 405. (See [405.9.](#))

**Fair Housing Accessibility Guidelines**

(Refer to ANSI A117.1 – 1986, section 4.8 – Ramps.)

## 2012 MI Building Code

### Section 1010 Ramp

**1010.6 Landings.** Ramps shall have landings at the bottom and top of each ramp, points of turning, entrance, exits and at doors. Landings shall comply with Section 1010.7.1 through 1010.7.5.

**1010.10 Edge protection.** Edge protection complying with Section 1010.10.1 or 1010.10.2 shall be provided on each side of ramp runs and at each side of ramp landings.

#### ***EXCEPTIONS:***

1. Edge protection is not required on ramps that are not required to have handrails, provided they have flared sides that comply with the ICC A117.1 curb ramp provisions.
2. Edge protection is not required on the sides of ramp landings serving an adjoining ramp run or stairway.
3. Edge protection is not required on the sides of ramp landings having a vertical drop-off of not more than 1/2 inch (12.7mm) within 10 inches (254 mm) horizontally of the required landing area.
4. In assembly spaces with fixed seating, edge protection is not required on the sides of ramps where the ramps provide access to the adjacent seating and aisle access ways.

**1010.10.1 Curb, rail, wall or barrier.** A curb, rail, wall or barrier shall be provided to serve as edge protection. A curb shall be a minimum of 4 inches (102 mm) in height. Barriers shall be constructed so that the barrier prevents the passage of a 4-inch-diameter (102 mm) sphere, where any portion of the sphere is within 4 inches (102 mm) of the floor or ground surface.

**2015 MI Residential Code** (*Nothing on Ramps - Edge Protection.*)

**106.8 Handrails.** Ramps with a rise greater than 6" shall have graspable handrails. Handrail height, measured above the finished surface of the ramp slope, shall be not less than 34" and not more than 36".

#### **ANSI A117.1 – 2009**

##### **1002 Accessible Units**

**1002.6 Ramps.** Shall comply with Section 405 Ramps. (See [405.8](#), [505.1](#) and [505.4](#).)

#### **ANSI A117.1 – 2009**

##### **1003 Type A Units**

**1003.6 Ramps.** Shall comply with Section 405 Ramps. (See [405.8](#), [505.1](#) and [505.4](#).)"

#### **ANSI A117.1- 2003**

##### **1004 Type B Units**

**1004.6 Ramps.** Shall comply with Section 405 Ramps. (See [405.8](#), [505.1](#) and [505.4](#).)

#### **Fair Housing Accessibility Guidelines**

(Refer to ANSI A117.1 – 1986, section 4.8 – Ramps.)

8/8/2016 10:04:11 AM

[www.zerostep.org](http://www.zerostep.org)

## 2012 MI Building Code

### Section 1013 Guards

**1013.4 Opening limitations.** Required guards shall not have openings, which allow passage of a sphere 4 inches (102 mm) in diameter from the walking surface to the required guard height.

#### **EXCEPTIONS:**

1. From a height of 36 inches (914 mm) to 42 inches (1067 mm), guards shall not have openings which allow passage of a sphere 4 3/8 inches (111 mm) in diameter.
2. The triangular openings at the open sides of a stair, formed by the riser, tread and bottom rail shall not allow passage of a sphere 6 inches (152 mm) in diameter.
3. At elevated walking surfaces for access to and use of electrical, mechanical or plumbing systems or equipment, guards shall have balusters or be of solid materials such that a sphere 21 inches (533 mm) in diameter.
3. In areas which are not open to the public within occupancies in Group I – 3, F, H or S and for alternating tread devices and ship ladders, guards shall not have openings which allow passage of a sphere 21 Inches (533 mm) In diameter.
4. In assembly seating areas, guards at the end of aisles where they terminate at a fascia of boxes, balconies and galleries shall have balusters or ornamental patterns such that a 4 – inch – diameter (102 mm) sphere cannot pass through any opening up to a height of 26 inches (660 mm). From a height of 26 inches (660 mm) to 42 inches (1067 mm) above the adjacent walking surfaces, a sphere 8 inches (203 mm) in diameter shall not pass.
5. Within individual dwelling units and sleeping units in Group R-2 and R-3 occupancies, openings for required guards on the sides of stair treads shall not allow a sphere of 4 3/8 inches (111 mm) to pass through.

## 2015 MI Residential Code

### Section 311 Means of Egress

**R311.8.3 Handrails Required.** Handrails shall be provided on not less than one side of ramps exceeding a slope of one unit vertical in 12 units horizontal (8.33-percent).

### Section R312 Guards

**R312.1 Where Required.** Guards shall be located along open-sided walking surfaces including stairs, ramps and landings that are located more than 30 inches (762 mm) measured vertically to the floor or grade below at any point within 36 inches (914 mm) horizontally to the edge of the open side. Insect screening shall not be considered as a guard.

**R312.2 Height.** Required guards at open-sided walking surfaces including stairs, porches, balconies or landings, shall be not less than 36 inches (914 mm) in height as measured vertically above the adjacent walking surface or the line connecting the leading edges of the treads.

#### Exceptions:

1. Guards on the open sides of stairs shall have a height of not less than 34 inches (864 mm) measured vertically from a line connecting the leading edges of the treads.
2. Where the top of the guard also serves as a handrail on the open sides of stairs, the top of the guard shall not be not less than 34 Inches (864 mm) and not more than 38 inches (965 mm) measured vertically from a line

connecting the leading edges of the treads

**R312.3 Opening Limitations.** Required guards shall not have openings from the walking surface to the required guard height, which allow passage of a sphere 4 inches (102 mm) in diameter.

Exceptions:

1. The triangular openings at the open side of a stair, formed by the riser, tread and bottom rail of a guard shall not allow passage of a sphere 6 inches (153 mm) in diameter.
2. Guards on the open sides of stairs shall not have openings, which allow passage of a sphere 4 3/8 inches (111 mm) in diameter.

**106.8.1 Handrail Location.** Handrails shall be provided on both sides of ramp.

**EXCEPTION:** Ramps that are parallel and attached to the home or garage may have one continuous handrail on the side opposite the home or garage.

**ANSI A117.1 – 2009**

**405 Ramps**

**405.8 Handrails.** Ramp runs with a rise greater than 6 inches (150 mm) shall have handrails complying with Section 505. (See [505.2](#).)

**505 Handrails**

**505.1 General.** Handrails required by Section 405.8 for ramps, or Section 504.6 for stairs, shall comply with Section 505 Handrails.

**505.2 Location.** Handrails shall be provided on both sides of stairs and ramps.

**EXCEPTION:** Aisle stairs and aisle ramps provided with a handrail either at the side or within the aisle width.

**ANSI A117.1 – 2009**

**1002 Accessible Units**

**1002.6 Ramps.** Shall comply with Section 405. (See [405.8](#) and [505.2](#).)

**ANSI A117.1 – 2009**

**1003 Type A Units**

**1003.6 Ramps.** Shall comply with Section 405. (See [405.8](#) and [505.2](#).)

**ANSI A117.1- 2003**

**1004 Type B Units**

**1004.6 Ramps.** Shall comply with Section 405. (See [405.8](#) and [505.2](#).)

**Fair Housing Accessibility Guidelines**

(Refer to ANSI A117.1 – 1986, section 4.8 – Ramps.)

8/8/2016 10:04:11 AM

[www.zerostep.org](http://www.zerostep.org)

Appendix B: Code Comparisons 122

## 2012 MI Building Code

### Section 1010 Ramps

**1010.8 Handrails.** Ramps with a rise greater than 6 inches (152 mm) shall have handrails on both sides. Handrails shall comply with Section 1012.

### Section 1012 Handrails.

**1012.1 Where required.** Handrails for stairways and ramps shall be adequate in strength and attachment in accordance with Section 1607.7. Handrails required for stairways by Sections 1009.15 shall comply with Sections 1012.2 through 1012.9. Handrails required for ramps by Section 1010.9 shall comply with Sections 1012.2 through 1012.8

### Section 1028 Assembly

**1028.13 Handrails.** Ramped aisles having a slope exceeding one unit vertical in 15 units horizontal (6.7-percent slope) and aisle stairs shall be provided with handrails in compliance with Section 1012 located either at one or both sides of the aisle or within the aisle width.

#### **EXCEPTIONS:**

1. Handrails are not required for ramped aisles having a gradient no greater than one unit vertical in eight units horizontal (12.5-percent slope) and seating on both sides.
2. Handrails are not required if, at the side of the aisle, there is a guard that complies with the grasp-ability requirements of handrails.
3. Handrail extensions are not required at the top and bottom of aisle stairs and aisle ramp runs to permit crossovers within the aisles.

## 2015 MI Residential Code

**R311.8.3 Handrails required.** Handrails shall be provided on not less than one side of ramps exceeding a slope of one unit vertical in 12 units horizontal (8.33-percent slope).

**R311.8.3.1 Height.** Handrail height, measured above the finished surface of the ramp slope, shall be not less than 34 inches (864 mm) and not more than 38 inches (965 mm).

## 106.8.2 Handrail Continuity. Handrails shall be continuous.

### ANSI A117.1 – 2009

#### 505 Handrails

**505.3 Continuity.** Handrails shall be continuous within the full length of each stair flight or ramp run. Inside handrails on switchback or dogleg stairs or ramps shall be continuous between flights or runs. Other handrails shall comply with Sections 505.10 and 307.

### ANSI A117.1 – 2009

#### 1002 Accessible Units

**1002.6 Ramps.** Ramps shall comply with Section 405.7 and Section 505. (See 505.3.)

8/8/2016 10:04:11 AM

[www.zerostep.org](http://www.zerostep.org)

Appendix B: Code Comparisons 123

**ANSI A117.1 – 2009**

**1003 Type A Units**

**1003.6 Ramps.** Ramps shall comply with Section 405.7 and Section 505. (See [505.3](#).)

**ANSI A117.1 – 2009**

**1004 Type B Units**

**1004.6 Ramps.** Ramps shall comply with Section 405.8 and Section 505. (See [505.3](#).)

**Fair Housing Accessibility Guidelines**

(Refer to ANSI A117.1 – 1986, section 4.8 – Ramps.)

**2012 MI Building Code**

**Section 1012 Handrails.**

**1012.4 Continuity.** Handrail gripping surfaces shall be continuous without interruption by newel posts or other obstructions.

**EXCEPTIONS:**

1. Handrails within dwelling units are permitted to be interrupted by a newel post at a turn or a landing.
2. Within a dwelling unit, the use of a volute, turnout, starting easing or starting newels allowed over the lowest tread.
3. Handrail brackets or balusters attached to the bottom surface of the handrail that do not project horizontally beyond the sides of the handrail within 1 1/2 inches (38 mm) of the bottom of the handrail shall not be considered obstructions. For each 1/2 inch (12.7 mm) of additional handrail perimeter dimension above 4 inches (102 mm), the vertical clearance dimension of 1 1/2 inches (38 mm) shall be permitted to be reduced by 1/8 inch (3 mm).
4. Where handrails are provided along walking surfaces with slopes not steeper than 1:20, the bottoms of the handrail gripping surfaces shall be permitted to be obstructed along their entire length where they are integral to crash rails or bumper guards.

**2015 MI Residential code**

**R311.8.3 Handrails required.** Handrails shall be provided on not less than one side of ramps exceeding a slope of one unit vertical in 12 units horizontal (8.33-percent slope).

**R311.8.3.3 Continuity.** Handrails where required on ramps shall be continuous for the full length of the ramp. Handrail ends shall be returned or shall terminate in newel posts or safety terminals. Handrails adjacent to a wall shall have a space of not less than 1 1/2 inches (38 mm) between the wall and the handrails.

**106.8.3 Balusters.** The space between balusters shall not exceed 4".

**ANSI A117.1 – 2009**

**1002 Accessible Units** (*Nothing on Ramps – balusters.*)

**ANSI A117.1 – 2009**

8/8/2016 10:04:11 AM

[www.zerostep.org](http://www.zerostep.org)

**1003 Type A Units** *(Nothing on Ramps – balusters.)*

**ANSI A117.1 – 2009**

**1004 Type B Units** *(Nothing on Ramps – balusters.)*

**Fair Housing Accessibility Guidelines** *(Nothing on balusters.)*

**2015 MI Building Code**

**Section 1013 Guards**

**1013.4 Opening limitations.** Required guards shall not have openings, which allow passage of a sphere 4 inches (102 mm) in diameter from the walking surface to the required guard height.

**EXCEPTIONS:**

1. From a height of 36 inches (914 mm) to 42 inches (1067 mm), guards shall not have openings which allow passage of a sphere 4 3/8 inches (111 mm) in diameter.
2. The triangular openings at the open sides of a stair, formed by the riser, tread and bottom rail shall not allow passage of a sphere 6 inches (152 mm) in diameter.

**2015 MI Residential Code**

**Section R312 Guards.** See Michigan Residential Building Code R312.3 Guards, Opening limitations.

**106.9 Handrail Clearance and Graspability.** The handrail clearance shall be 1 ½" minimum from an adjacent surface. Handrails with a circular cross section shall have a perimeter dimension of 4" minimum and 6 ¼" maximum, and a cross-section dimension of 2 ¼" maximum.

**ANSI A117.1 – 2009**

**405 Ramps**

**405.8 Handrails.** Ramp runs with a rise greater than 6 inches (150 mm) shall have handrails complying with Section 505. (See [505.5](#), [505.6](#), [505.7](#), [505.7.1](#), and [505.7.2](#).)

**505 Handrails**

**505.7 Cross Section.** Handrails shall have a cross section complying with Section 505.7.1 or 505.7.2.

**505.7.1 Circular Cross Section.** Handrails with a circular cross section shall have an outside diameter of 1 ¼ inches (32 mm) minimum and 2 inches (51 mm) maximum.

**505.7.2 Noncircular Cross Sections.** Handrails with a noncircular cross section shall have a perimeter dimension of 4 inches (100 mm) minimum and 6 ¼ inches (160 mm) maximum, and a cross-section dimension of 2 ¼ inches (57 mm) maximum.

**ANSI A117.1 – 2009**

**1002 Accessible Units**

**1002.6 Ramps.** Shall comply with Section 405. (See [405.8](#), [505.7](#), [505.7.1](#), and [505.7.2](#).)

8/8/2016 10:04:11 AM

[www.zerostep.org](http://www.zerostep.org)



**ANSI A117.1 – 2009**

**1003 Type A Units**

**1003.6 Ramps.** Shall comply with Section 405. (See [405.8](#), [505.7](#), [505.7.1](#), and [505.7.2](#).)

**ANSI A117.1 – 2009**

**1004 Type B Units**

**1004.6 Ramps.** Ramps shall comply with Section 405. (See [405.8](#), [505.7](#), [505.7.1](#), and [505.7.2](#).)

**Fair Housing Accessibility Guidelines**

(Refer to ANSI A117.1 – 1986, section 4.9 – Stairs.)

**2012 MI Building Code**

**Section 1012 Handrails**

**1012.3 Handrail grasp-ability.** All required handrails shall comply with Section 1012.3.1 or shall provide equivalent grasp-ability.

**EXCEPTIONS:**

1. In Group R-3 occupancies; within dwelling units in Group R-2 occupancies; and in Group U occupancies that are accessory to a Group R-3 occupancy or accessory to individual dwelling units in Group R-2 occupancies; handrails shall be Type I in accordance with Section 1012.3.1, Type II in accordance with Section 1012.3.2 or shall provide equivalent grasp-ability

**1012.3.1 Type I.** Handrails with a circular cross section shall have an outside diameter of at least 1 1/4 inches (32 mm) and not greater than 2 inches (51 mm). If the handrail is not circular, it shall have a perimeter dimension of at least 4 inches (102 mm) and not greater than 6 1/4 inches (160 mm) with a maximum cross-section dimension of 2 1/4 inches (57 mm). Edges shall have a minimum radius of 0.01 inch (0.25 mm).

**1012.3.2 Type II.** Handrails with a perimeter greater than 6 1/4 inches (160 mm) shall provide a graspable finger recess area on both sides of the profile. The finger recess shall begin within a distance of 3/4 inch (19 mm) measured vertically from the tallest portion of the profile and achieve a depth of at least 5/16 inch (8 mm) with 7/8 inch (22 mm) below the widest portion of the profile. This required depth shall continue for at least 3/8 inch (10 mm) to a level that is not less than 1 3/4 inches (45 mm) below the tallest portion of the profile. The minimum width of the handrail above the recess shall be 1 1/4 Inches (32 mm) to a maximum of 2 3/4 inches (70 mm). Edges shall have a minimum radius of 0.01 inch (0.25 mm).

**1012.7 Clearance.** Clear space between a handrail and a wall or other surface shall be a minimum of 1 1/2 inches (38 mm). A handrail and a wall or other surface adjacent to the handrail shall be free of any sharp or abrasive elements.

**2015 MI Residential Codes**

**Section R311 Means of Egress**

**R311.8 Ramps.**

**R311.8.3 Handrails required.**

8/8/2016 10:04:11 AM

[www.zerostep.org](http://www.zerostep.org)

**R311.8.3.2 Grip size.** Handrails on ramps shall comply with Section R311.7.8.3.

**R311.7.8.3 Grip-size.** All required handrails shall be of one of the following types or provide equivalent graspability.

1. Type I. Handrails with a circular cross section shall have an outside diameter of not less than 1 ¼ inches (32 mm) and not greater than 2 inches (51 mm). If the handrail is not circular it shall have a perimeter dimension of not less than 4 inches (102 mm) and not greater than 6 ¼ inches (160 mm) with a cross section of dimension of not more than 2 ¼ inches (57 mm). Edges shall have a radius of not less than 0.01 inch (0.25 mm).
2. Type II. Handrails with a perimeter greater than 6 ¼ inches (160 mm) shall provide a graspable finger recess area on both sides of the profile. The finger recess shall begin within a distance of ¾ inch (19 mm) measured vertically from the tallest portion of the profile and achieve a depth of at least 5/16 inch (8 mm) within 7/8 inch (22 mm) below the widest portion of the profile. This required depth shall continue for not less than 3/8 inch (10 mm) to a level that is not less than 1 ¼ inches (45 mm) below the tallest portion of the profile. The width of the handrail above the recess shall be not less than 1 ¼ inches (32 mm) and not more than 2 ¼ inches (70 mm). Edges shall have a radius of not less than 0.01 inches (0.25mm).

**106.10 Outdoor Conditions.** Outdoor ramps and outdoor approaches to ramps shall be designed so that water will not accumulate on walking surfaces.

**ANSI A117.1 – 2009**

**405 Ramps**

**405.10 Wet Conditions.** Landings subject to wet conditions shall be designed to prevent the accumulation of water.

**ANSI A117.1 – 2009**

**1002 Accessible Units**

**1002.6 Ramps.** Shall comply with Section 405. (See [405.10](#).)

**ANSI A117.1 – 2009**

**1003 Type A Units**

**1003.6 Ramps.** Shall comply with Section 405. (See [405.10](#).)

**ANSI A117.1 – 2009**

**1004 Type B Units**

**1004.6 Ramps.** Ramps shall comply with Section 405. (See [405.10](#).)

**Fair Housing Accessibility Guidelines**

(Refer to ANSI A117.1 – 1986, section 4.5 – Ground and floor surface treatments: Accessible routes, rooms and spaces, including floors, walks, ramps, stairs, and curb ramps.)

**2012 MI Building Code**

**Section 1010 Ramp.**

8/8/2016 10:04:11 AM

[www.zerostep.org](http://www.zerostep.org)

Appendix B: Code Comparisons 127

**1010.8.2 Outdoor conditions.** Outdoor ramps and outdoor approaches to ramps shall be designed so that water will not accumulate on walking surfaces.

**2015 MI Residential Code** *(Nothing on Ramps - Outdoor Conditions.)*

**106.11 Ramp Surface.** The ramp surface shall be of slip-resistant materials that are securely attached, or a brushed concrete surface. Decking shall be installed perpendicular to the path of travel with at least 1/8" gaps between boards to allow for drainage.

**ANSI A117.1 – 2009**  
**405 Ramps**

**405.4 Floor Surfaces.** Floor surfaces of ramp runs shall comply with Section 302. (See [302.1](#), [302.2](#), and [302.3](#).)

**ANSI A117.1 – 2009**  
**1002 Accessible Units**

**1002.6 Ramps.** Ramps shall comply with Section 405. (See [405.4](#).)

**ANSI A117.1 – 2009**  
**1003 Type A Units**

**1003.6 Ramps.** Ramps shall comply with Section 405. (See [405.4](#).)

**ANSI A117.1 – 2009**  
**1004 Type B Units**

**1004.6 Ramps.** Ramps shall comply with Section 405. (See [405.4](#).)

**405.4 Floor Surfaces.** Floor surfaces of ramp runs shall comply with Section 302. (See [302.1](#), [302.2](#), and [302.3](#).)

#### **Fair Housing Accessibility Guidelines**

(Refer to ANSI A117.1 – 1986, section 4.5 – Ground and Floor Surfaces.)

**2012 MI Building Code**  
**Section 1010 Ramps.**

**1010.8 Ramp construction.** All ramps shall be built of materials consistent with the types permitted for the type of construction of the building, except that wood handrails shall be permitted for all types of construction.

**1010.8.1 Ramp surface.** The surface of ramps shall be of slip-resistant materials that are securely attached.

**1010.8.2 Outdoor conditions.** Outdoor ramps and outdoor approaches to ramps shall be designed so that water will not accumulate on walking surfaces.

**2015 MI Residential Code** *(Nothing on Ramps - Ramp Surfaces.)*

8/8/2016 10:04:11 AM

[www.zerostep.org](http://www.zerostep.org)

**These requirements are derived from the most recent edition of The ANSI Reference Codes, The Fair Housing Guidelines, The Michigan Building Codes and The Michigan Residential Codes. As these codes are updated, so too will the ZeroStep™ Guidelines.**



## Chapter 2. Interior Accessible Routes and Spaces

The contents of this section define what a ZeroStep™ interior accessible route is. Following each ZeroStep™ guidelines section are provided references to the most recent edition of The ANSI REference Codes, The Fair Housing Guidelines, The Michigan Building Codes, and The Michigan Residential Codes, from which the measures and dimensions requirements were derived and expanded upon.

**Interior Accessible Route begins at the exterior entrance to the home.**

### 201 Doors and Doorways

**201.1 Zero-Step Exterior Entrance.** There shall be at least two zero-step exterior entrances on an accessible route to the home, with one being the homeowner's preferred primary entrance. This shall comply with Sections 104.3 and 101.1 (see Fig. 104.3).

ANSI A117.1 – 2009

#### 404 Doors and Doorways

**404.1 General.** Doors and doorways that are part of an accessible route shall comply with Section 404.

**404.2 Manual Doors.** Manual doors and doorways, and manual gates, including ticket gates, shall comply with the requirements of Section 404.2.

**EXCEPTION:** Doors, doorways, and gates designed to be operated only by security personnel shall not be required to comply with Sections 404.2.6, 404.2.7, and 404.2.8.

**404.2.1 Double-Leaf Doors and Gates.** At least one of the active leaves of doorways with two leaves shall comply with Sections 404.2.2 and 404.2.3.

**404.2.2 Clear Width.** Doorways shall have a clear opening width of 32 inches (815 mm) minimum. Clear opening width of doorways with swinging doors shall be measured between the face of door and stop, with the door open 90 degrees. Openings more than 24 inches (610 mm) in depth at doors and doorways without doors shall provide a clear opening width of 36 inches (915 mm) minimum. There shall be no projections into the clear opening width lower than 34 inches (865 mm) above the floor. Projections into the clear opening width between 34 inches (865 mm) and 80 inches (2030 mm) above the floor shall not exceed 4 inches (100 mm).

#### **EXCEPTIONS:**

1. Door closers and door stops shall be permitted to be 78 inches (1980 mm) minimum above the floor.
2. In alterations, a projection of 5/8 inch (16 mm) maximum into the required clear opening width shall be

8/8/2016 10:04:11 AM

[www.zerostep.org](http://www.zerostep.org)

Appendix B: Code Comparisons 130

permitted for the latch side stop.

**404.2.3.1 Floor Surface.** Floor surface within the maneuvering clearances shall have a slope not steeper than 1:48 and shall comply with Section 302. (See [302.1](#), [302.2](#), and [302.3](#).)

**404.2.3.2 Swinging Doors.** Swinging doors shall have maneuvering clearances complying with Table 404.2.3.2.

**404.2.3.3 Sliding and Folding Doors.** Sliding doors and folding doors shall have maneuvering clearances complying with Table 404.2.3.3.

**404.2.3.4 Doorways without Doors.** Doorways without doors that are less than 36 inches (915 mm) in width shall have maneuvering clearances complying with Table 404.2.3.4.

**404.2.3.5 Recessed Doors.** Where any obstruction within 18 inches (455 mm) of the latch side of a doorway projects more than 8 inches (205 mm) beyond the face of the door, measured perpendicular to the face of the door, maneuvering clearances for a forward approach shall be provided.

**404.2.4 Thresholds at Doorways.** If provided, thresholds at doorways shall be ½ inch (13 mm) maximum in height. Raised thresholds and changes in level at doorways shall comply with Sections 302 and 303. (See [302.1](#), [302.2](#), [302.3](#), [303.1](#), [303.2](#), and [303.3](#).)

**EXCEPTION:** Section 404.2.4 shall not apply to existing thresholds or altered thresholds ¾ inch (19 mm) maximum in height that have a beveled edge on each side with a maximum slope of 1:2 for the height exceeding ¾ inch (6.4 mm).

**404.3.3 Thresholds.** Thresholds and changes in level at doorways shall comply with Section [404.2.4](#).

## ANSI A117.1 – 2009

### 1002 Accessible Units

**1002.2 Primary Entrance.** The accessible primary entrance shall be on an accessible route from public and common areas. The primary entrance shall not be to a bedroom unless it is the only entrance.

**1002.5 Doors and Doorways.** The primary entrance door to the dwelling unit, and all other doorways intended for user passage, shall comply with Section 404. (See [404.1](#), [404.2](#), [404.2.1](#), [404.2.2](#), [404.2.3.1](#), [404.2.3.2](#), [404.2.3.3](#), [404.2.3.4](#), [404.2.3.5](#), [404.2.4](#), and [404.3.3](#).)

#### **EXCEPTION:**

1. Existing doors to hospital patient sleeping rooms shall be exempt from the requirement for space at the latch side provided the door is 44 inches (1120 mm) minimum in width.
2. In toilet rooms and bathrooms not required to comply with Section 1002.11.2, maneuvering clearances required by [Section 404.2.3](#) are not required on the toilet room or bathroom side of the door.
3. A turning space between doors in a series as required by [Section 404.2.5](#) is not required.
4. Storm and screen doors are not required to comply with [Section 404.2.5](#).
5. Communicating doors between individual sleeping units are not required to comply with [Section 404.2.5](#).
6. At other than the primary entrance door, where exterior space dimensions of balconies are less than the required maneuvering clearance, door maneuvering clearance is not required on the exterior side of the door.

**ANSI A117.1 – 2009**

**1003 Type A Units**

**1003.2 Primary Entrance.** The accessible primary entrance shall be on an accessible route from public and common areas. The primary entrance shall not be to a bedroom unless it is the only entrance.

**1003.5 Doors and Doorways.** The primary entrance door to the dwelling, and all other doorways intended for user passage, shall comply with Section 404. (See [404.1](#), [404.2](#), [404.2.1](#), [404.2.2](#), [404.2.3.1](#), [404.2.3.2](#), [404.2.3.3](#), [404.2.3.4](#), [404.2.3.5](#), [404.2.4](#), and [404.3.3](#).)

**EXCEPTIONS:**

1. Existing doors to hospital patient sleeping rooms shall be exempt from the requirement for space at the latch side provided the door is 44 inches (1120 mm) minimum in width.
2. In toilet rooms and bathrooms not required to comply with Section 1002.11.2, maneuvering clearances required by [Section 404.2.3](#) are not required on the toilet room or bathroom side of the door.
3. A turning space between doors in a series as required by [Section 404.2.5](#) is not required.
4. Storm and screen doors are not required to comply with [Section 404.2.5](#).
5. Communicating doors between individual sleeping units are not required to comply with [Section 404.2.5](#).
6. At other than the primary entrance door, where exterior space dimensions of balconies are less than the required maneuvering clearance, door maneuvering clearance is not required on the exterior side of the door.

**ANSI A117.1 – 2009**

**1004 Type B Units**

**1004.1 General.** Type B units shall comply with Section 1004.

**1004.2 Primary Entrance.** The accessible primary entrance shall be on an accessible route from public and common areas. The primary entrance shall not be to a bedroom unless it is the only entrance.

**1004.5 Doors and Doorways.** Doors and doorways shall comply with Section 1004.5.

**1004.5.1 Primary Entrance Door.** The primary entrance door to the unit shall comply with Section 404.

**EXCEPTION:** Storm and screen doors serving individual dwelling or sleeping units are not required to comply with Section 404.2.5.

**1004.5.2 User Passage Doorways.** Doorways intended for user passage shall comply with Section 1004.5.2.

**1004.5.2.1 Clear Width.** Doorways shall have a clear opening of 31 ¾ inches (805 mm) minimum. Clear opening of swinging doors shall be measured between the face of the door and stop, with the door open 90 degrees.

**1004.5.2.1.1 Double Leaf Doorways.** Where the operable parts on an inactive leaf of a double leaf doorway are located more than 48 inches (1220 mm) or less than 15 inches (380 mm) above the floor, the active leaf shall provide the clearance required by Section 1004.5.2.1.

**1004.5.2.2 Thresholds.** Thresholds shall comply with Section 303. (See [303.1](#), [303.2](#), and [303.3](#).)

**EXCEPTION:** Thresholds at exterior sliding doors shall be permitted to be ¾ inch (19 mm) maximum in height, provided they are beveled with a slope not steeper than 1:2.

**1004.5.2.3 Automatic Doors.** Automatic doors shall comply with Section 404.3.

#### Fair Housing Accessibility Guidelines

**Section 100.205(c)(2)** would apply to doors that are a part of an accessible route in the public and common use areas of multifamily dwellings and to doors into and within individual dwelling units.

**Section 100.205(c)(2)(1).** On accessible routes in public and common use areas, and for primary entry doors to covered units, doors that comply with A117.1 – 1986 would meet this requirement.

**Section 100.205(c)(2)(2).** Within individual dwelling units, doors intended for user passage through the unit which have a clear opening of at least 32" nominal width when the door is open 90 degrees, measured between the face of the door and the stop, would meet this requirement. Openings more than 24 inches in depth are not considered doorways. (See Fig. 1 (d).)

See Section 100.205(c)(3)(i)(4), Section 100.205(c)(3)(i)(5), and Section 100.205(c)(3)(i)(6).

#### 2012 MI Building Code

##### Section 1008 Doors, Gates and Turnstiles

**1008.1 Doors.** Means of egress doors shall meet the requirements of this section. Doors serving a means of egress system shall meet the requirements of this section and Section 1020.2. Doors provided for egress purposes in numbers greater than required by this code shall meet the requirements of this section.

Means of egress doors shall be readily distinguishable from the adjacent construction and finishes such that the doors are easily recognizable as doors. Mirrors or similar reflecting materials shall not be used on means of egress doors. Means of egress doors shall not be concealed by curtains, drapes, decorations, or similar materials.

**1008.1.1 Size of doors.** The minimum width of each door opening shall be sufficient for the occupant load thereof and shall provide a clear width of not less than 32 inches (813 mm). Clear openings of doorways with swing doors shall be measured between the face of the door and the stop, with the door open 90 degrees (1.57 rad). Where this section requires a minimum clear width of 32 inches (813 mm) and a door opening includes two door leaves without a mullion, one leaf shall provide a clear opening width of 32 inches (813 mm). The maximum width of a swinging door leaf shall be 48 inches (1219 mm) nominal. Means of egress doors in a Group I-2 occupancy used for the movement of beds shall provide a clear width not less than 41.5 inches (1054 mm). The height of doors shall not be less than 80 inches (2032 mm).

#### **EXCEPTIONS:**

1. The minimum and maximum width shall not apply to door openings that are not part of the required means of egress in Group R-2 and R-3 occupancies.
2. Door openings to resident sleeping units in Group I-3 occupancies shall have a clear width of not less than 28 inches (711 mm).
3. Door openings to storage closets less than 10 square feet (0.03m<sup>2</sup>) in area shall not be limited by the minimum width.
4. Width of door leaves in revolving doors that comply with Section 1008.1.3.1 shall not be limited.
5. Door openings within a dwelling unit or sleeping unit shall not be less than 78 inches (1981 mm) in height.
6. Exterior door openings in dwelling units and sleeping units, other than the required exit door, shall not be less than 76 inches (1930 mm) in height.
7. In other than Group R-1 occupancies, the minimum widths shall not apply to interior egress doors within a



- dwelling unit or sleeping unit that is not required to be an Accessible unit, Type A unit or Type B unit.
8. Door openings required to be accessible within Type B units shall have a minimum clear width of 31.75 inches (806 mm).

#### Section 1105 Accessible Entrances

**1105.1.6 Tenant spaces, dwelling units and sleeping units.** At least one accessible entrance shall be provided to each tenant, dwelling unit and sleeping unit in a facility.

##### **EXCEPTIONS:**

1. An accessible entrance is not required to tenants that are not required to be accessible.
2. An accessible entrance is not required to dwelling units and sleeping units that are not required to be Accessible units, Type A units or Type B units.

#### 2015 MI Residential Code

##### Section R311 Means of Egress.

**R311.1 Means of Egress.** Dwellings shall be provided with a means of egress In accordance with this section. The means of egress shall provide a continuous and unobstructed path of vertical and horizontal egress travel from all portions of the dwelling to the required egress door without requiring travel through a garage. The required egress door shall open directly into a public way or to a yard or court that opens to a public way.

**R311.2 Door Type and Size.** The required door shall be a side-hinged door not less than 3 feet in width and 6 feet, 8 inches (2032 mm) in height. Other exterior hinged or sliding doors shall not be less than 24 inches (609 mm) In width and 6 feet, 6 Inches (1980 mm) in height.

**R311.2.1 Interior Doors.** Interior door shall not be less than 24 Inches (609 mm) in width and 6 feet, 6 inches (1980 mm) in height.

**Exception:** Doors to areas less than 10 square feet of floor area.

**201.2 Clear Width.** Doors and doorways that are on an accessible route shall have a clear opening width of 34" minimum, which is typically accomplished by a 36" wide door.

#### ANSI A117.1 – 2009

##### 1002 Accessible Units

**1002.5 Doors and Doorways.** The primary entrance door to the unit, and all other doorways intended for user passage, shall comply with [Section 404](#). (See [404.2.2](#) and [404.2.3](#))

##### **EXCEPTIONS:**

1. Existing doors to hospital patient sleeping rooms shall be exempt from the requirement for space at the latch side provided the door is 44 inches (1120 mm) minimum in width.
2. In toilet rooms and bathrooms not required to comply with Section 1002.11.2, maneuvering clearances required by [Section 404.2.3](#) are not required on the toilet room or bathroom side of the door.
3. A turning space between doors in a series as required by [Section 404.2.5](#) is not required.
4. Storm and screen doors are not required to comply with [Section 404.2.5](#).
5. Communicating doors between individual sleeping units are not required to comply with [Section 404.2.5](#).
6. At other than the primary entrance door, where exterior space dimensions of balconies are less than the required maneuvering clearance, door maneuvering clearance is not required on the exterior side of the door.

## ANSI A117.1 – 2009

### 1003 Type A Units

**1003.5 Doors and Doorways.** The primary entrance door to the unit, and all other doorways intended for user passage, shall comply with [Section 404](#). (See [404.2.2](#) and [404.2.3](#))

#### **EXCEPTIONS:**

1. Thresholds at exterior sliding doors shall be permitted to be  $\frac{3}{4}$  inch (19 mm) maximum in height, provided they are beveled with a slope not greater than 1:2.
2. In toilet rooms and bathrooms not required to comply with Section 1003.11.2, maneuvering clearances required by [Section 404.2.3](#) are not required on the toilet room or bathroom side of the door.
3. A turning space between doors in a series as required by [Section 404.2.5](#) is not required.
4. Storm and screen doors are not required to comply with [Section 404.2.5](#).
5. Communicating doors between individual sleeping units are not required to comply with [Section 404.2.5](#).
6. At other than the primary entrance door, where exterior space dimensions of balconies are less than the required maneuvering clearance, door maneuvering clearance is not required on the exterior side of the door.

## ANSI A117.1 – 2009

### 1004 Type B Units

**1004.2 Primary Entrance.** The accessible primary entrance shall be on an accessible route from public and common areas. The primary entrance shall not be to a bedroom unless it is the only entrance.

**1004.5 Doors and Doorways.** Doors and doorways shall comply with Section 1004.5. (See [1004.5.1](#) and [1004.5.2](#).)

**1004.5.1 Primary Entrance Door.** The primary entrance door to the unit shall comply with Section 404.

**EXCEPTION:** Storm and screen doors serving individual dwelling or sleeping units are not required to comply with Section 404.2.5.

### Fair Housing Accessibility Guidelines

See Section [100.205 \(c\)\(2\)\(2\)](#).

## 2012 MI Building Code

### Section 1008 Doors, Gates and Turnstiles

See [1008.1.1](#).

**1008.1 Doors.** Means of egress doors shall meet the requirements of this section. Doors serving a means of egress system shall meet the requirements of this section and Section 1020.2. Doors provided for egress purposes in numbers greater than required by this code shall meet the requirements of this section.

Means of egress doors shall be readily distinguishable from the adjacent construction and finishes such that the doors are easily recognizable as doors. Mirrors or similar reflecting materials shall not be used on means of egress doors. Means of egress doors shall not be concealed by curtains, drapes, decorations, or similar materials.

**1008.1.1.1 Projections into clear width.** There shall not be projections into the required clear width lower than 34 inches (864 mm) above the floor or ground. Projections into the clear opening width between 34 inches (864 mm) and 80 inches (2032 mm) above the floor or ground shall not exceed 4 inches (102 mm).

**EXCEPTION:** Door closers and door stops shall be permitted to be 78 inches (1980 mm) minimum above the

floor.

#### Section 1105 Accessible Entrances

**1105.1.6 Tenant spaces, dwelling units and sleeping units.** At least one accessible entrance shall be provided to each tenant, dwelling unit and sleeping unit in a facility.

##### **EXCEPTIONS:**

1. An accessible entrance is not required to tenants that are not required to be accessible.
2. An accessible entrance is not required to dwelling units and sleeping units that are not required to be Accessible units, Type A units or Type B units.

#### 2015 MI Residential Code

##### Section R311 Means of Egress.

**R311.1 Means of Egress.** Dwellings shall be provided with a means of egress In accordance with this section. The means of egress shall provide a continuous and unobstructed path of vertical and horizontal egress travel from all portions of the dwelling to the required egress door without requiring travel through a garage. The required egress door shall open directly into a public way or to a yard or court that opens to a public way.

**R311.2 Door Type and Size.** The required door shall be a side-hinged door not less than 3 feet in width and 6 feet, 8 inches (2032 mm) in height. Other exterior hinged or sliding doors shall not be less than 24 inches (609 mm) in width and 6 feet, 6 Inches (1980 mm) in height.

**R311.2.1 Interior Doors.** Interior door shall not be less than 24 Inches (609 mm) in width and 6 feet, 6 inches (1980 mm) in height.

**EXCEPTION:** Doors to areas less than 10 square feet of floor area.

**201.3 18" Minimum Maneuvering Clearances.** Are on the push pull, latch side of the door.

#### ANSI A117.1-2009

##### 404 Doors and Doorways

**404.1 General.** Doors and doorways that are part of an accessible route shall comply with Section 404.

**404.2.3 Maneuvering Clearances.** Minimum maneuvering clearances at doors shall comply with Section 404.2.3 and shall include the full clear opening width of the doorway. Required door maneuvering clearances shall not include knee and toe clearance. (see TABLE 404.2.3.2-Maneuvering Clearances at manual swing doors).

**201.4 Swinging Doors, Sliding and Folding Doors, Doorways Without Doors and Pocket Doors.** Swinging doors, sliding and folding doors, doorways without doors and pocket doors that are on an accessible route shall have a clear opening width of 34" minimum.

**EXCEPTION:** Pantries and closets other than accessible closets addressed in Section 201 may have less than a clear opening width of 34".

#### ANSI A117.1 – 2009

##### 1002 Accessible Units

8/8/2016 10:04:11 AM

[www.zerostep.org](http://www.zerostep.org)

**1002.5 Doors and Doorways.** The primary entrance door to the unit, and all other doorways intended for user passage, shall comply with [Section 404](#). (See [404.2.2](#) and [404.2.3](#).)

**EXCEPTIONS:**

1. Existing doors to hospital patient sleeping rooms shall be exempt from the requirement for space at the latch side provided the door is 44 inches (1120 mm) minimum in width.
2. In toilet rooms and bathrooms not required to comply with Section 1002.11.2, maneuvering clearances required by [Section 404.2.3](#) are not required on the toilet room or bathroom side of the door.
3. A turning space between doors in a series as required by [Section 404.2.5](#) is not required.
4. Storm and screen doors are not required to comply with [Section 404.2.5](#).
5. Communicating doors between individual sleeping units are not required to comply with [Section 404.2.5](#).
6. At other than the primary entrance door, where exterior space dimensions of balconies are less than the required maneuvering clearance, door maneuvering clearance is not required on the exterior side of the door.

**ANSI A117.1 – 2009**

**1003 Type A Units**

**1003.5 Doors and Doorways.** The primary entrance door to the unit, and all other doorways intended for user passage, shall comply with [Section 404](#). (See [404.2.2](#) and [404.2.3](#).)

**EXCEPTIONS:**

1. Thresholds at exterior sliding doors shall be permitted to be  $\frac{3}{4}$  inch (19 mm) maximum in height, provided they are beveled with a slope not greater than 1:2.
2. In toilet rooms and bathrooms not required to comply with Section 1003.11.2, maneuvering clearances required by [Section 404.2.3](#) are not required on the toilet room or bathroom side of the door.
3. A turning space between doors in a series as required by [Section 404.2.5](#) is not required.
4. Storm and screen doors are not required to comply with [Section 404.2.5](#).
5. Communicating doors between individual sleeping units are not required to comply with [Section 404.2.5](#).
6. At other than the primary entrance door, where exterior space dimensions of balconies are less than the required maneuvering clearance, door maneuvering clearance is not required on the exterior side of the door.

**ANSI A117.1 – 2009**

**1004 Type B Units**

**1004.2 Primary Entrance.** The accessible primary entrance shall be on an accessible route from public and common areas. The primary entrance shall not be to a bedroom.

**1004.5 Doors and Doorways.** Doors and doorways shall comply with Section 1004.5. (See [1004.5.1](#), [1004.5.2](#), [1004.5.2.1](#), [1004.5.2.2](#), [1004.5.2.3](#), and [1004.5.2.4](#).)

**Fair Housing Accessibility Guidelines**

(See Section [100.205\(c\)\(2\)\(2\)](#).)

**2009 MI Building Code**

**Section 1008 Doors, Gates and Turnstiles**

**1008.1.2 Door swing.** Egress doors shall be of the pivoted or side-hinged swinging type.

**EXCEPTIONS:**

4. Doors within or serving a single dwelling unit in Groups R-2 and R-3.
8. Doors serving a bathroom within an individual sleeping unit in Group R-1.
9. In other than Group H occupancies, manually operated horizontal sliding doors are permitted as a means of egress from spaces with an occupant load of 10 or less.

**2012 MI Building Code**

**Section 1008 Doors, Gates and Turnstiles**

**1008.1.2 Door swing.** Egress doors shall be of the pivoted or side-hinged swinging type.

**EXCEPTIONS:**

4. Doors within or serving a single dwelling unit in Groups R-2 and R-3.
8. Doors serving a bathroom within an individual sleeping unit in Group R-1.
9. In other than Group H occupancies, manually operated horizontal sliding doors are permitted as a means of egress from spaces with an occupant load of 10 or less.

**2015 MI Residential Code**

**Section R311 Means of Egress.**

**R311.1 Means of Egress.** Dwellings shall be provided with a means of egress in accordance with this section. The means of egress shall provide a continuous and unobstructed path of vertical and horizontal egress travel from all portions of the dwelling to the required egress door without requiring travel through a garage. The required egress door shall open directly into a public way or to a yard or court that opens to a public way.

**R311.2 Door Type and Size.** The required door shall be a side-hinged door not less than 3 feet in width and 6 feet, 8 inches (2032 mm) in height. Other exterior hinged or sliding doors shall not be less than 24 inches (609 mm) in width and 6 feet, 6 inches (1980 mm) in height.

**R311.2.1 Interior Doors.** Interior door shall not be less than 24 inches (609 mm) in width and 6 feet, 6 inches (1980 mm) in height.

**EXCEPTION:** Doors to areas less than 10 square feet of floor area.

**201.5 Changes in Level.** Doors and doorways that are on an accessible route comply with Section 104.3.1 – 104.3.3 Walks and Pathways.

**ANSI A117.1 – 2009**

**1002 Accessible Units**

**1002.5 Doors and Doorways.** The primary entrance door to the unit, and all other doorways intended for user passage, shall comply with [Section 404](#). (See [404.2.2](#) and [404.2.3](#).)

**EXCEPTIONS:**

1. Existing doors to hospital patient sleeping rooms shall be exempt from the requirement for space at the latch side provided the door is 44 inches (1120 mm) minimum in width.
2. In toilet rooms and bathrooms not required to comply with Section 1002.11.2, maneuvering clearances required by [Section 404.2.3](#) are not required on the toilet room or bathroom side of the door.
3. A turning space between doors in a series as required by [Section 404.2.5](#) is not required.

4. Storm and screen doors are not required to comply with [Section 404.2.5](#).
5. Communicating doors between individual sleeping units are not required to comply with [Section 404.2.5](#).
6. At other than the primary entrance door, where exterior space dimensions of balconies are less than the required maneuvering clearance, door maneuvering clearance is not required on the exterior side of the door.

#### ANSI A117.1 – 2009

##### 1003 Type A Units

**1003.5 Doors and Doorways.** The primary entrance door to the unit, and all other doorways intended for user passage, shall comply with [Section 404](#). (See [404.2.2](#) and [404.2.3](#))

##### EXCEPTIONS:

1. Thresholds at exterior sliding doors shall be permitted to be  $\frac{3}{4}$  inch (19 mm) maximum in height, provided they are beveled with a slope not greater than 1:2.
2. In toilet rooms and bathrooms not required to comply with Section 1003.11.2, maneuvering clearances required by [Section 404.2.3](#) are not required on the toilet room or bathroom side of the door.
3. A turning space between doors in a series as required by [Section 404.2.5](#) is not required.
4. Storm and screen doors are not required to comply with [Section 404.2.5](#).
5. Communicating doors between individual sleeping units are not required to comply with [Section 404.2.5](#).
6. At other than the primary entrance door, where exterior space dimensions of balconies are less than the required maneuvering clearance, door maneuvering clearance is not required on the exterior side of the door.

#### ANSI A117.1 – 2009

##### 1004 Type B Units

**1004.5 Doors and Doorways.** Doors and doorways shall comply with Section 1004.5. (See [1004.5.2.2](#).)

**1004.5.1 Primary Entrance Door.** The primary entrance door to the unit shall comply with Section 404.

**EXCEPTION:** Storm and screen doors serving individual dwelling or sleeping units are not required to comply with Section 404.2.5.

##### Fair Housing Accessibility Guidelines

See Section [100.205\(c\)\(3\)\(i\)\(4\)](#), [100.205\(c\)\(3\)\(i\)\(5\)](#), and [100.205\(c\)\(3\)\(i\)\(6\)](#).

#### 2012 MI Building Code

##### Section 1008 Doors, Gates and Turnstiles

**1008.1.5 Floor Elevation.** There shall be a floor or landing on each side of a door. Such Floor or landing shall be at the same elevation on each side of the door. Landings shall be level except for exterior landings, which are permitted to have a slope not to exceed 0.25 unit vertical in 12 units horizontal (2-percent slope).

##### EXCEPTIONS:

1. Doors serving individual dwelling units in Groups R-2 and R-3 as applicable in Section 101.2 where the following apply:
  - 1.1. A door is permitted to open at the top step of an interior flight of stairs, provided the door does not swing over the top step.
  - 1.2. Screen doors and storm doors are permitted to swing over stairs or landings.
2. Exterior doors as provided for in Section 1003.5, Exception 1, and Section 1017.2, which are not on an

accessible route.

3. In Group R-3 occupancies, the landing at an exterior doorways shall not be more than 7 ¾ inches (197 mm) below the top of the threshold, provided the door, other than an exterior storm or screen door, does not swing over the landing.
4. Variations in elevation due to differences in finish materials, but not more than 1/2 inch (12.7 mm).
5. Exterior decks, patios or balconies that are part of Type B dwelling units and have impervious surfaces, and that are not more than 4 inches (102 mm) below the finished floor level of the adjacent interior space of the dwelling unit.

**1008.1.7 Thresholds.** Thresholds at doorways shall not exceed 3/4 inch (19.1 mm) in height for sliding doors serving dwelling units or 1/2 inch (12.7 mm) for other doors. Raised thresholds and floor level changes greater than 1/4 inch (6.4 mm) at doorways shall be beveled with a slope not greater than one unit vertical in two units horizontal (50-percent slope).

**EXCEPTION:** The threshold height shall be limited to 7 ¾ inches (197 mm) where the occupancy is Group R-2 or R-3 as applicable in Section 101.2, the door is an exterior door that is not a component of the required means of egress; the door, other than an exterior storm or screen door, does not swing over the landing or step; and the doorway is not on an accessible route as required by Chapter 11 and is not part of an accessible unit, Type A unit or Type B unit.

#### 2015 MI Residential Code Section R311 Means of Egress

**R311.3 Floors and landings at exterior doors.** There shall be a landing or floor on each side of each exterior door. The width of each landing shall not be less than the door served. Every landing shall have a minimum dimension of 36 inches (914 mm) measured in the direction of travel. Exterior landings shall be permitted to have a slope not to exceed 1/4 unit vertical in 12 units horizontal (2-percent).

**EXCEPTION:** Exterior balconies less than 60 square feet (5.6 mm) and only accessible from a door are permitted to have a landing less than 36 inches (914 mm) measured in the direction of travel.

**R311.3.1 Floor elevations at the required egress doors.** Landings or floors at the required egress door shall not be more than 1 1/2 inches (38 mm) lower than the top of the threshold.

**EXCEPTION:** The exterior landing or floor shall not be more than 7 3/4 inches (196 mm) below the top of the threshold provided the door does not swing over the landing or floor.

When exterior landings or floors serving the required egress door are not at grade, they shall be provided with access to grade by means of a ramp in accordance with Section R311.8 or a stairway in accordance with Section R311.7.

**R311.3.2 Floor Elevations at the required for other exterior doors.** Doors other than the required egress door shall be provided with the landing or floors not more than 7 3/4 inches (196 mm) below the top of the threshold.

**Exception:** A top landing is not required where a stairway of not more than two risers is located on the exterior side of the door, provided that the door does not swing over the stairway.

**201.6 Split Level Landing.** No split level landings are permitted at a zero-step entrance into the home. For example, a "back landing" where the exterior door swings over a landing and there

8/8/2016 10:04:11 AM

[www.zerostep.org](http://www.zerostep.org)

are additional steps to climb before reaching a kitchen.

**ANSI A117.1 – 2009**

**1002 Accessible Units** *(Nothing on Split Level Landing.)*

**ANSI A117.1 – 2009**

**1003 Type A Units** *(Nothing on Split Level Landing.)*

**ANSI A117.1 – 2009**

**1004 Type B Units** *(Nothing on Split Level Landing.)*

**Fair Housing Accessibility Guidelines** *(Nothing on Split Level Landing.)*

**2012 MI Building Code** *(Nothing on Split Level Landing.)*

**2015 MI Residential Code** *(Nothing on split Level Landing.)*

**201.7 Two Doors in Series.** Minimum maneuvering clearances shall be at double doors on an accessible route. Door swings shall not infringe on the 5' turning space.

**ANSI A117.1 – 2009**

**1002 Accessible Units**

**1002.5 Doors and Doorways.** The primary entrance door to the unit, and all other doorways intended for user passage, shall comply with [Section 404](#). (See [404.2.5](#).)

**EXCEPTIONS:**

1. Existing doors to hospital patient sleeping rooms shall be exempt from the requirement for space at the latch side provided the door is 44 inches (1120 mm) minimum in width.
2. In toilet rooms and bathrooms not required to comply with Section 1002.11.2, maneuvering clearances required by [Section 404.2.3](#) are not required on the toilet room or bathroom side of the door.
3. A turning space between doors in a series as required by [Section 404.2.5](#) is not required.
4. Storm and screen doors are not required to comply with [Section 404.2.5](#).
5. Communicating doors between individual sleeping units are not required to comply with [Section 404.2.5](#).
6. At other than the primary entrance door, where exterior space dimensions of balconies are less than the required maneuvering clearance, door maneuvering clearance is not required on the exterior side of the door.

**ANSI A117.1 – 2009**

**1003 Type A Units**

**1003.5 Doors and Doorways.** The primary entrance door to the unit, and all other doorways intended for user passage, shall comply with [Section 404](#). (See [404.2.5](#).)

**EXCEPTIONS:**

1. Thresholds at exterior sliding doors shall be permitted to be  $\frac{3}{4}$  inch (19 mm) maximum in height, provided they are beveled with a slope not greater than 1:2.
2. In toilet rooms and bathrooms not required to comply with Section 1003.11.2, maneuvering clearances required by [Section 404.2.3](#) are not required on the toilet room or bathroom side of the door.
3. A turning space between doors in a series as required by [Section 404.2.5](#) is not required.



4. Storm and screen doors are not required to comply with [Section 404.2.5](#).
5. Communicating doors between individual sleeping units are not required to comply with [Section 404.2.5](#).
6. At other than the primary entrance door, where exterior space dimensions of balconies are less than the Required maneuvering clearance, door maneuvering clearance is not required on the exterior side of the door.

#### ANSI A117.1 – 2009

##### 1004 Type B Units

**1004.5 Doors and Doorways.** Doors and doorways shall comply with Section 1004.5. (Nothing on Two Doors in Series)

**1004.5.1 Primary Entrance Door.** The primary entrance door to the unit shall comply with Section 404.

**EXCEPTION:** Storm and screen doors serving individual dwelling or sleeping units are not required to comply with Section 404.2.5.

##### Fair Housing Accessibility Guidelines

**Section 100.205(c)(2)** provides that covered multifamily dwellings with a building entrance on an accessible route shall be designed in such a manner that all the doors designed to allow passage into and within all premises are sufficiently wide to allow passage by handicapped persons in wheelchairs.

(1) On accessible routes in public and common use areas, and for primary entry doors to covered units, doors that comply with ANSI 4.13 would meet this requirement. ("Doors in a series are not typically part of an individual dwelling unit but are used at entrances to buildings. As such they are part of public and common use spaces and subject to the design specifications found in ANSI 4.13 Doors. However, where doors in a series are provided as part of a dwelling unit (to form an air lock when extremes of climate exist or to create a privacy vestibule), the requirements of an accessible route into and through the dwelling unit would apply.") Pg.3.13.

#### 2012 MI Building Code

##### Section 1008 Doors, Gates and Turnstiles

**1008.1.8 Door arrangement.** Space between two doors in series shall be 48 inches (1219 mm) minimum plus the width of a door swinging into the space. Doors in series shall swing either in the same direction or away from the space between doors.

**EXCEPTIONS:**

1. The minimum distance between horizontal sliding power-operated doors in a series shall be 48 inches (1219 mm).
2. Storm and screen doors servicing individual dwelling units in Groups R-2 and R-3 as applicable in Section 101.2 need not be spaced 48 inches (1219 mm) from the other door.
3. Doors within individual dwelling units in Groups R-2 and R-3 other than within Type A dwelling units.

**2015 MI Residential code** (*Nothing on Two Doors in a Series.*)

## 202 Hallways

**202.1 Width.** A 42" minimum width hallway is required on an accessible route.

8/8/2016 10:04:11 AM

[www.zerostep.org](http://www.zerostep.org)

**ANSI A117.1 – 2009**  
**1002 Accessible Units**

**1002.1 General.** Accessible units shall comply with Section 1002. (See [1002.3](#), [1002.3.1](#), [1002.3.2](#), and [1002.3.3](#).)

**ANSI A117.1 – 2009**  
**1003 Type A Units**

**1003.1 General.** Type A units shall comply with Section 1003. (See [1003.3](#), [1003.3.1](#), [1003.3.2](#), [1003.3.3](#) and [403](#).) (See [403.5](#).)

**ANSI A117.1 – 2009**  
**1004 Type B Units**

**1004.1 General.** Type B units shall comply with Section 1004. (See [1004.3](#), [1004.3.1](#), [1004.3.2](#), [1004.4](#), and [1004.4.1](#).)

**Fair Housing Accessibility Guidelines**

**Section 100.205(c)(3)(I)** provides that all covered multifamily dwellings with a building entrance on an accessible route shall be designed and constructed in such a manner that all premises within covered multifamily dwelling units contain an accessible route into and through the covered dwelling unit.

(1) A minimum clear width of 36 inches is provided.

**2012 MI Building Code**

**Section 1018 Corridors**

**1018.2 Width.** The minimum width of corridors specified in Table 1018.2 shall be as determined in Section 1005.1.

**Table 1018.2 Minimum corridor width.**

Occupancy	Width (Minimum)
Any facilities not listed below	44 inches
Access to and utilization of mechanical, plumbing, or electrical systems or equipment	24 inches
With required occupancy capacity less than 50	36 inches
Within a dwelling unit	36 inches
In Group E with a corridor having a required capacity of 100 or more	72 inches
In corridors and areas serving gurney traffic in occupancies where patients receive out-patient medical care, which causes the patient to be incapable of self-preservation	72 inches
Group I-2 in areas where required for bed movement	96 inches

**2015 MI Residential Code**

**R311.6 Hallways.** The width of a hallway shall be not less than 3 feet (914 mm).

## 202.2 Changes in Level. Shall comply with Section 104.3.1 – Section 104.3.3.

### ANSI A117.1 – 2009

#### 1002 Accessible Units

**1002.1 General.** Accessible units shall comply with Section 1002.

**1002.3 Accessible Route.** Accessible routes within Accessible units shall comply with Section 1002.3.

#### 1003 Type A Units

### ANSI A117.1 – 2009

**1003.1 General.** Type A units shall comply with Section 1003.

**1003.3 Accessible Route.** Accessible routes within Accessible units shall comply with Section 1003.3.

### ANSI A117.1 – 2009

#### 1004 Type B Units

**1004.1 General.** Type B units shall comply with Section 1004. (See 1004.4.2.)

#### Fair Housing Accessibility Guidelines

**Section 100.205(c)(3)(i)(2).** In single-story dwelling units, changes in level within the dwelling unit with heights between ¼ inch and ½ inch are beveled with a slope no greater than 1:2. Except for design features, such as a loft or an area on a different level within a room (e.g. a sunken living room), changes in level greater than ½ inch are ramped or have other means of access. Where a single story dwelling unit has special design features, all portions of the single-story unit, except the loft or the sunken or raised area, are on an accessible route; and

**(a)** In single-story dwelling units with lofts, all spaces other than the loft are on an accessible route.

**(b)** Design features such as sunken or raised functional areas do not interrupt the accessible route through the remainder of the dwelling unit.

**2012 MI Building Code** (*Nothing on Hallways – Changes in Level.*)

**2015 MI Residential Code** (*Nothing on Hallways - Changes In Level.*)

## 203 Stairways

### ANSI A117.1 – 2009

#### 504 Stairways

**504.1 General.** Accessible stairs shall comply with Section 504.

**504.2 Treads and Risers.** All steps on a flight of stairs shall have uniform riser height and uniform tread depth. Risers shall be 4 inches (100 mm) minimum and 7 inches (180 mm) maximum in height. Treads shall be 11 inches (280 mm) minimum in depth.

**504.3 Open Risers.** Open risers shall not be permitted.

8/8/2016 10:04:11 AM

[www.zerostep.org](http://www.zerostep.org)

Appendix B: Code Comparisons 144

**504.4 Tread Surface.** Stair treads shall comply with Section 302 (see [302.1](#), [302.2](#), and [302.3](#).) and shall have a slope not steeper than 1:48.

**504.5 Nosings.** The radius of curvature at the leading edge of the tread shall be ½ inch (13 mm) maximum. Nosings that project beyond risers shall have the underside of the leading edge curved or beveled. Risers shall be permitted to slope under the tread at an angle of 30 degrees maximum from vertical. The permitted projection of the nosing shall be 1 ½ inches (38 mm) over the tread or floor below.

**504.5.1 Visual contrast.** The leading 2 inches (51 mm) of the tread shall have visual contrast of dark-on-light or light-on-dark from the remainder of the tread.

**504.6 Handrails.** Stairs shall have handrails complying with Section 505. (See [505.2](#), [505.3](#), [505.5](#), [505.6](#), [505.7](#), [505.7.1](#), [505.7.2](#).)

**504.7 Wet Conditions.** Stair treads and landings subject to wet conditions shall be designed to prevent the accumulation of water.

**504.8 Lighting.** Lighting for interior stairways shall comply with Section 504.8.

**504.8.1 Illumination Level.** Lighting facilities shall be capable of providing 10 foot –candles (108 lux) of illuminance measured at the center of tread surfaces and on landing surfaces within 24 inches (610 mm) of step nosings.

**504.8.2 Lighting Controls.** If provided, occupancy-sensing automatic controls shall activate the stairway lighting so the luminance level required by Section 504.8.1 is provided on the entrance landing, each stair flight adjacent to the entrance landing, and on the landings above and below the entrance landing prior to any step being used.

#### ANSI A117.1 – 2009

##### 1002 Accessible Units

**1002.3 Accessible Route.** Accessible routes within Accessible units shall comply with Section 1002.3. (See [1002.3](#), [1002.3.1](#), [1002.3.2](#) and [504](#).) (See [504.1](#), [504.2](#), [504.3](#), [504.4](#), [504.5](#), [504.6](#), [504.7](#), [504.8](#), [504.8.1](#), [504.8.2](#).)

#### ANSI A117.1 – 2009

##### 1003 Type A Units

**1003.3 Accessible Route.** Accessible routes within Type A units shall comply with Section 1003.3. (See [1003.3](#), [1003.3.1](#), [1003.3.2](#) and [504](#).) (See [504.1](#), [504.2](#), [504.3](#), [504.4](#), [504.5](#), [504.6](#), [504.7](#), [504.8](#), [504.8.1](#), [504.8.2](#).)

#### ANSI A117.1 – 2009

##### 1004 Type B Units

**1004.3 Accessible Route.** Accessible routes within Accessible Type B units shall comply with Section 1004.3. (See [1004.3.1](#).)

#### Fair Housing Accessibility Guidelines

See Section [100.205\(c\)\(3\)\(ii\)\(4\)](#).

#### 2012 MI Building Code

8/8/2016 10:04:11 AM

[www.zerostep.org](http://www.zerostep.org)

## Section 1009 Stairways

**1009.7 Stair treads and risers.** Stair treads and risers shall comply with Section 1009.7.1 through 1009.7.5.

**1009.7.1 Dimension reference surfaces.** For the purpose of this section, all dimensions are exclusive of carpets, rugs, or runners.

**1009.7.2 Riser height and tread depth.** Stair riser heights shall be 7 inches (178 mm) maximum and 4 inches (102 mm) minimum. Stairs tread depths shall be 11 inches (279 mm) minimum. The riser height shall be measured vertically between the leading edges of adjacent treads. Rectangular tread depths shall be 11 inches (279 mm) minimum measured horizontally between the vertical planes of the foremost projection adjacent treads and at a right angle to the tread's leading edge. Winder treads shall have a minimum depth of 11 inches (279 mm) measured between the vertical planes of the foremost projection of adjacent treads at the Intersections with the walkline and a minimum tread depth of 10 inches (254 mm) within the clear width of the stair.

### **EXCEPTIONS:**

1. Alternating tread devices in accordance with Section 1009.13.
3. Spiral stairways in accordance with Section 1009.14.
4. Aisle stairs in assembly seating areas where the stair pitch or slope is set, for sightlines reasons, by the slope of the adjacent seating area in accordance with Section 1025.11.2.
5. In Group R-3 occupancies; within dwelling units in Group R-2 occupancies; and in Group U occupancies that are accessory to a Group R-3 occupancy or accessory to individual dwelling units in Group R-2 occupancies; the maximum riser height shall be 7.75 inches (197 mm) and the minimum tread depth shall be 10 inches (254 mm), the minimum winder tread depth shall be 6 inches (152 mm). A nosing not less than 0.75 inch (19.1 mm) but not more than 1.25 inch (32 mm) shall be provided on stairways with solid risers where the tread depth is less than 11 inches (279 mm).
6. See Section 3403.4 for the replacement of existing stairways.

## Section 1205 Lighting

**1205.4 Stairway illumination.** Stairways within dwelling units and exterior stairways serving a dwelling unit shall have an illumination level on tread runs of not less than 1 footcandle (11 lux). Stairs in other occupancies shall be governed by Chapter 10.

## 2015 MI Residential Code

### Section R311 Means of Egress

#### R311.7 Stairways.

**R311.7.4 Walkline.** The walkline across winder treads shall be concentric from the curved direction of travel through the turn and located 12 inches (305 mm) from the side where the winders are narrower. The 12-inch (305mm) dimension shall be measured from the widest point of the clear stair width at the walking surface of the winder. If winders are adjacent within the flight, the point of the widest clear stair width of the adjacent winders shall be used.

**R311.7.4.1 Riser height.** The maximum riser height shall be 8 ¼ inches (210 mm). The riser shall be measured vertically between leading edges of the adjacent treads. The greatest riser height within any flight of stairs shall not exceed the smallest by more than 3/8 inch (9.5 mm).

**R311.7.4.2 Tread Depth.** The minimum tread depth shall be 9 inches (229 mm). The tread depth shall be measured horizontally between the vertical planes of the foremost projection of adjacent treads and at a

right angle to the tread's leading edge. The greatest tread depth within any flight of stairs shall not exceed the smallest by more than 3/8 inch (9.5 mm). Winder treads shall have a minimum tread depth of 10 inches (254 mm) measured as above at a point 12 inches (305 mm) from the side where the treads are narrower. Winder treads shall have a minimum tread depth of 6 inches (152 mm) at any point. Within any flight of stairs, the greatest winder tread depth at the 12 Inch (305 mm) walk line shall not exceed the smallest by more than 3/8 inch (9.5 mm).

#### **R311.7.5 Stair treads and risers.**

**R311.7.5.1 Risers.** The riser height shall be not more than 7 3/4 inches (196 mm). The riser shall be measured vertically between the leading edges of the adjacent treads. The greatest riser height within any flight of stairs shall not exceed the smallest by more than 3/8 inch (9.5 mm). Risers shall be vertical or sloped from the underside of the nosing of the tread above at an angle not more than 30 degrees (0.51 rad) from the vertical. Open risers are permitted provided that the openings located more than 30 inches (762 mm), as measured vertically, to the floor or grade below do not permit the passage of a 4-inch-diameter (102 mm) sphere.

**R311.7.5.2 Treads.** The tread depth shall be not more than 10 inches (254 mm). The Tread depth shall be measured horizontally between the vertical planes of the angle to the tread's leading edge. The greatest tread depth within any flight of stairs shall not exceed the smallest by more than 3/8 Inch (9.5 mm).

**R311.7.5.2.1 Winder Treads.** Winder treads shall have a tread depth of not less than 10 inches (254 mm) measured between the vertical planes of the foremost projection of adjacent treads at the intersections with the walkline. Winder treads shall have a tread depth of not less than 6 inches (152 mm) at any point within the clear width of the stair. Within any flight of stairs, the largest winder tread depth at the walkline shall not exceed the smallest winder tread by more than 3/8 inch (9.5 mm). Consistently shaped winders at the walkline shall be allowed with the same flight of stairs as rectangular treads and do not have to be within 3/8 inch (9.5 mm) of the rectangular tread depth.

**Exception:** The tread depth at spiral stairways shall be in accordance with Section R311.7.10.1

**R311.7.5.3 Nosings.** The radius of the curvature at the nosing shall be not greater than 9/16 Inch (14 mm). A nosing projection not less than 3/4 inch (19 mm) and not more than 1 1/4 inches (32 mm) shall be provided on the stairways with solid risers. The greatest nosing projection shall not exceed the smallest nosing projection by more than 3/8 inch (9.5 mm) between two stories, including the nosing at the level of floors and landings. Beveling of nosings shall not exceed 1/2 inch (12.7 mm).

**Exception:** A nosing projection is not required where the tread depth is not less than 11 inches (279 mm).

### **203.1 Interior Landing At Exterior Doorway.** Shall comply with Section 201.4.

**ANSI A117.1 – 2009**

**1002 Accessible Units** (*Nothing on Stairways – Interior Landing At Exterior Door.*)

**ANSI A117.1 – 2009**

**1003 Type A Units** (*Nothing on Stairways – Interior Landing At Exterior Door.*)

**ANSI A117.1 – 2009**

8/8/2016 10:04:11 AM

[www.zerostep.org](http://www.zerostep.org)

**1004 Type B Units** *(Nothing on Stairways – Interior Landing At Exterior Door.)*

**Fair Housing Accessibility Guidelines** *(Nothing on Stairways – Interior Landing At Exterior Door.)*

## **2012 MI Building Code**

### **Section 1008 Doors, Gates and Turnstiles**

**1008.1.6 Landings at doors.** Landings shall have a width not less than the width of the stairway or the door, whichever is greater. Doors in the fully open position shall not reduce a required dimension by more than 7 inches (178 mm). When a landing serves an occupant load of 50 or more, doors in any position shall not reduce the landing to less than one-half its required width. Landings shall have a length measured in the direction of travel of not less than 44 inches (1118 mm).

**EXCEPTION:** Landing length in the direction of travel in Groups R-3 and U and within individual units of Group R-2 need not exceed 36 inches (914 mm).

### **Section 1009 Stairways**

**1009.8 Stairway landings.** There shall be a floor or landing at the top and bottom of each stairway. The width of landings shall not be less than the width of stairways they serve. Every landing shall have a minimum dimension measured in the direction of travel equal to the width of the stairway. Such dimension need not exceed 48 inches (1219 mm) where the stairway has a straight run. Doors opening onto a landing shall not reduce the landing to less than one-half the required width. When fully open, the door shall not project more than 7 inches (178 mm) into a landing. When wheelchair spaces are required on the stairway landing in accordance with Section 1007.6.1, the wheelchair space shall not be located in the required width of the landing and doors shall not swing over the wheelchair spaces.

**EXCEPTIONS:**

1. Aisle stairs complying with Section 1028.

## **2015 MI Residential Code**

### **R311 Means of Egress**

**R311.7.6 Landings for stairways.** There shall be a floor or landing at the top and bottom of each stairway. The width perpendicular to the direction of travel shall be not less than the width of the flight served. Landings of shapes other than square or rectangular shall be permitted provided that the depth of the walk line and the total area is not less than that of a quarter circle with a radius equal to the required landing width. Where the stairway has a straight run, the depth in the direction of travel shall not be less than 36 inches (914 mm).

**Exception:** A floor or landing is not required at the top of an interior flight of stairs, including stairs in an enclosed garage, provided that a door does not swing over the stairs.

**203.2 Stairway Lighting.** All interior and exterior stairways shall be provided with a means to illuminate the stairs, the landings and treads. Interior stairways shall be provided with an artificial light source located in the immediate vicinity of each landing of the stairway.

**EXCEPTION:** An artificial light source is not required at the top and bottom landing,

8/8/2016 10:04:11 AM

[www.zerostep.org](http://www.zerostep.org)

provided an artificial light source is located directly over each stairway section.

**ANSI A117.1 – 2009**

**1002 Accessible Units**

(See Sections [504.8](#) and [504.8.1](#).)

**ANSI A117.1 – 2009**

**1003 Type A Units**

(See Sections [504.8](#) and [504.8.1](#).)

**ANSI A117.1 – 2009**

**1004 Type B Units**

(See Sections [504.8](#) and [504.8.1](#).)

**Fair Housing Accessibility Guidelines** (*Nothing on Stairway Lighting.*)

**2012 MI Building Code**

**Section 1205 Lighting**

1205.4 Stairway illumination. Stairways within dwelling units and exterior stairways serving a dwelling unit shall have an illumination level on tread runs of not less than 1 foot-candle (11 lux). Stairs in other occupancies shall be governed by Chapter 10.

**2015 MI Residential Code**

**Section R303 Light, Ventilation and Heating**

**R303.7 Interior stairway illumination.** Interior stairways shall be provided with an artificial light source to illuminate the landings and treads. The light source shall be capable of illuminating treads and landings to levels of not less than 1 foot-candle (11 lux) as measured at the venter of treads and landings. There shall be a wall switch at each floor level to control the light source where the stairway has six or more risers.

**Exception:** A switch is not required where remote, central or automatic control of lighting is provided.

**R303.7.1 Light activation.** Where lighting outlets are installed in interior stairways, there shall be a wall switch at each floor level to control the lighting outlets where the stairway has six or more risers. The illumination of exterior stairways shall be controlled from inside the dwelling unit.

**Exception:** Lights that are continuously illuminated or automatically controlled.

**R303.8 Exterior stairway illumination.** Exterior stairways shall be provided with an artificial light source located at the top landing of the stairway. Exterior stairways providing access to a basement from the outdoor grade level shall be provided with an artificial light source located at the bottom landing of the stairway.

**203.3 Lighting Controls.** The control for activation of the required interior stairway light shall be accessible at the top and bottom of each stairway without traversing any steps. The illumination of exterior stairways shall be controlled from inside the dwelling unit.

**EXCEPTION:** Lights that are continuously illuminated or automatically controlled.

**1002 Accessible Units**

8/8/2016 10:04:11 AM

[www.zerostep.org](http://www.zerostep.org)



(See Section [504.8.2](#).)

**ANSI A117.1 – 2009**

**1003 Type A Units**

(See Section [504.8.2](#).)

**ANSI A117.1 – 2009**

**1004 Type B Units**

(See Section [504.8.2](#).)

**Fair Housing Accessibility Guidelines**

**Section 100.205(c)(3)(ii)** requires that all covered multifamily dwellings with a building entrance on an accessible route shall be designed and constructed in such a manner that all premises within covered multifamily dwelling units contain light switches, electrical outlets, thermostats, and other environmental controls in accessible locations.

**Guideline** – Light switches, electrical outlets, thermostats, and other environmental controls would meet Section 100.205(c)(3)(ii) if operable parts of the controls are located no higher than 48 inches, and no lower than 15 inches, above the floor. If the reach is over an obstruction (for example, an overhanging shelf) between 20 and 25 inches in depth, the maximum height is reduced to 44 inches for forward approach; or 46 inches for side approach, provided the obstruction (for example, a kitchen base cabinet) is no more than 24 inches in depth. Obstructions should not extend more than 25 inches from the wall beneath a control.

**2012 MI Building Code**

**Section 1205 Lighting**

**1205.4 Stairway Illumination.**

**1205.4.1 Controls.** The control for activation of the required stairway lighting shall be in accordance with NFPA 70.

**2015 MI Residential Code**

**Section R303 Light, Ventilation and Heating**

**R303.7 Interior stairway illumination.** Interior stairways shall be provided with an artificial light source to illuminate the landings and treads. The light source shall be capable of illuminating treads and landings to levels of not less than 1 foot-candle (11 lux) as measured at the venter of treads and landings. There shall be a wall switch at each floor level to control the light source where the stairway has six or more risers.

**Exception:** A switch is not required where remote, central or automatic control of lighting is provided.

**R303.7.1 Light activation.** Where lighting outlets are installed in interior stairways, there shall be a wall switch at each floor level to control the lighting outlets where the stairway has six or more risers. The illumination of exterior stairways shall be controlled from inside the dwelling unit.

**Exception:** Lights that are continuously illuminated or automatically controlled.

**R303.8 Exterior stairway illumination.** Exterior stairways shall be provided with an artificial light source located at the top landing of the stairway. Exterior stairways providing access to a basement from the outdoor grade level shall be provided with an artificial light source located at the bottom landing of the stairway.

## 204 Elevators

### ANSI A117.1 – 2009

#### 1002 Accessible Units

**1002.7 Elevators.** Elevators within the unit shall comply with Section 407, 408, or 409.

### ANSI A117.1 – 2009

#### 1003 Type A Units

**1003.7 Elevators.** Elevators within the unit shall comply with Section 407, 408, or 409.

### ANSI A117.1 – 2009

#### 1004 Type B Units

**1004.7 Elevators.** Elevators within the unit shall comply with Section 407, 408, or 409.

#### Fair Housing Accessibility Guidelines

**Section 100.205(C)(1)** provides that covered multifamily dwellings with a building entrance on an accessible route shall be designed in such a manner that the public and common use areas are readily accessible to and usable by handicapped persons.

#### Guideline

The following chart identifies the public and common use areas that should be made accessible, cites the appropriate section of the ANSI Standard, and describes the appropriate application of the specifications, including modifications to the reference Standard. (Elevators included here.)

#### 2012 MI Building Code

##### Section 1007 Accessible Means of Egress

**1007.2.1 Elevators required.** In buildings where a required accessible floor is four or more stories above or below a level of exit discharge, at least one required accessible means of egress shall be an elevator complying with Section 1007.4.

**1007.4 Elevators.** To be considered part of an accessible means of egress, an elevator shall comply with the emergency operation and signaling device requirements of the Michigan elevator code, R 408.7001 to R 408.8695.

**2015 MI Residential Code** (*Nothing on elevators.*)

## 205 Balconies, Lofts, Raised or Sunken Areas and Split-Level Entries

**205.1 Balconies, Lofts, Raised or Sunken Areas and Split-Level Entries.** Balconies, lofts, raised or sunken areas and split-level entries are not recommended, however if they are designed into a dwelling, they must not interfere with the accessible route or with the accessible

bathroom, kitchen, and living room.

**ANSI A117.1 – 2009**

**1002 Accessible Units**

**1002.3 Accessible Route.** Accessible routes within Accessible units shall comply with Section 1002.3. (See [302.1](#), [302.2](#), [302.3](#), [303.1](#), [303.2](#), and [303.3](#).)

**ANSI A117.1 – 2009**

**1003 Type A Units**

**1003.3 Accessible Route.** Accessible routes within Type A units shall comply with Section 1003.3. (See [302.1](#), [302.2](#), [302.3](#), [303.1](#), [303.2](#), and [303.3](#).)

**ANSI A117.1 – 2009**

**1004 Type B Units**

**1004.3 Accessible Route.** Accessible routes within Type B units shall comply with Section 1004.3. (See 1004.3.1 Exception.)

**Fair Housing Accessibility Guidelines**

**Section 100.205(c)(3)(i)(2).** In single-story dwelling units, changes in level within the dwelling unit with heights between ¼ inch and ½ inch are beveled with a slope no greater than 1:2. Except for design features, such as a loft or an area on a different level within a room (e.g. a sunken living room), changes in level greater than ½ inch are ramped or have other means of access. Where a single story dwelling unit has special design features, all portions of the single-story unit, except the loft or the sunken or raised area, are on an accessible route; and

(a) In single-story dwelling units with lofts, all spaces other than the loft are on an accessible route.

(b) Design features such as sunken or raised functional areas do not interrupt the accessible route through the remainder of the dwelling unit.

See Section [100.205\(c\)\(2\)\(2\)](#).

**2012 MI Building Code**

**Section 1104 Accessible Route**

**1104.4 Multilevel buildings and facilities.** At least one accessible route shall connect each accessible level, including mezzanines, in multilevel buildings and facilities.

**EXCEPTIONS:**

1. An accessible route is not required to stories and mezzanines above and below accessible levels that have an aggregate area of not more than 3,000 square feet (278.7 m<sup>2</sup>). This exception shall not apply to:
  - 1.1. Multiple tenant facilities of Group M occupancies containing five or more tenant spaces;
  - 1.2. Levels containing offices or health care providers (Group A-3 or B); or
  - 1.3. Passenger transportation facilities and airports (Group A-3 or B).
4. Where a two-story building or facility has one story with an occupant load of five or fewer persons that does not contain public use space, that story shall not be required to be connected by an accessible route to the story

above or below.

**2015 MI Residential Code** *(Nothing on Balconies, Lofts, Raised or Sunken Areas and Split-level Entries.)*

**These requirements are derived from the most recent edition of The ANSI Reference Codes, The Fair Housing Guidelines, The Michigan Building Codes and The Michigan Residential Codes. As these codes are updated, so too will the ZeroStep™ Guidelines.**

**The next edition of the ANSI Reference Codes is planned to increase the clear turning spaces from 60-inches in diameter to 67-inches in diameter. When the new editions are released, the ZeroStep™ Guidelines will be revised. Disability Advocates of Kent County recommends that these changes be considered in current construction design.**



## Chapter 3. Bathrooms

The contents of this section define what a ZeroStep™ bathroom is. Following each ZeroStep™ guideline section are provided references to the most recent edition of The ANSI Reference Codes, The Fair Housing Guidelines, The Michigan Building Codes, and The Michigan Residential Codes, from which the measures and dimensions requirements were derived and expanded upon.

### 301 Bathrooms

**301.1 Location.** There shall be at least one full size bathroom (consisting of a sink, toilet, and bathtub or shower) on the main floor, on an accessible route, near an accessible bedroom.

#### ANSI A117.1 – 2009

##### 1002 Accessible Units

**1002.3 Accessible Route.** Accessible routes within Accessible units shall comply with Section 1002.3. (See 302.1, 302.2, 302.3, 303.1, 303.2, and 303.3.)

**1002.3.1 Location.** At least one accessible route shall connect all spaces and elements that are a part of the unit. Accessible routes shall coincide with or be located in the same area as a general circulation path.

**EXCEPTION:** An accessible route is not required to unfinished attics and unfinished basements that are part of the unit.

**1002.11 Toilet and Bathing Facilities.** At least one toilet and bathing facility shall comply with Section 1002.11.2. All other toilet and bathing facilities shall comply with Section 1002.11.1

**1002.11.2 Accessible Toilet and Bathing Facility.** At least one toilet and bathing facility shall comply with Section 603. At least one lavatory, one water closet and either a bathtub or shower within the unit shall comply with Sections 604 through 610. The accessible toilet and bathing fixtures shall be in a single toilet/bathing area, such that travel between fixtures does not require travel through other parts of the unit.

#### ANSI A117.1 – 2009

##### 1003 Type A Units

**1003.3 Accessible Route.** Accessible routes within Accessible units shall comply with Section 1003.3. (See 302.1, 302.2, 302.3, 303.1, 303.2, and 303.3.)

**1003.3.1 Location.** At least one accessible route shall connect all spaces and elements that are a part of the unit.

8/8/2016 10:04:11 AM

[www.zerostep.org](http://www.zerostep.org)

Accessible routes shall coincide with or be located in the same area as a general circulation path.

**EXCEPTION:** An accessible route is not required to unfinished attics and unfinished basements that are part of the unit.

**1003.11 Toilet and Bathing Facilities.** At least one toilet and bathing facility shall comply with Section 1003.11.2. All toilet and bathing facilities shall comply with Section 1003.11.1.

**1003.11.2 General.** At least one toilet and bathing facility shall comply with Section 1003.11.2. At least one lavatory, one water closet and either a bathtub or shower within the unit shall comply with Section 1003.11.2. The accessible toilet and bathing fixtures shall be in a single toilet/bathing area, such that travel between fixtures does not require travel through other parts of the unit.

**1003.11.1 Grab Bar and Shower Seat Reinforcement.** Reinforcement shall be provided for the future installation of grab bars complying with [Section 604.5](#) at water closets; grab bars complying with [Section 607.4](#) at bathtubs; and for grab bars and shower seats complying with [Sections 608.3](#), [608.2.1.3](#), [608.2.2.3](#) and [608.2.3.2](#) at shower compartments.

**EXCEPTIONS:**

1. At fixtures not required to comply with Section 1003.11.2, reinforcement in accordance with Section 1004.11.1 shall be permitted.
2. Reinforcement is not required in a room containing only a lavatory and a water closet, provided the room does not contain the only lavatory or water closet on the accessible level of the dwelling unit.
3. Reinforcement for the water closet side wall vertical grab bar component required by [Section 604.5](#) is not required.
4. Where the lavatory overlaps the water closet clearance in accordance with the exception to Section 1003.11.2.4.4 reinforcement at the water closet rear wall for a 24-inch (610 mm) minimum length grab bar, centered on the water closet, shall be provided.

**ANSI A117.1 – 2009**

**1004 Type B Units**

**1004.3 Accessible Route.** Accessible routes within Accessible Type B units shall comply with Section 1004.3. (See [1004.3.1](#).)

**1004.3.1 Location.** At least one accessible route shall connect all spaces and elements that are a part of the unit. Accessible routes shall coincide with or be located in the same area as a general circulation path.

**EXCEPTIONS:**

1. An accessible route is not required to unfinished attics and unfinished basements that are part of the unit.
2. One of the following is not required to be on an accessible route:
  - 2.1 A raised floor area in a portion of a living, dining, or sleeping room; or
  - 2.2 A sunken floor area in a portion of a living, dining, or sleeping room; or
  - 2.3 A mezzanine that does not have plumbing fixtures or an enclosed habitable space.

**1004.11 Toilet and Bathing Facilities.** Toilet and bathing fixtures shall comply with Section 1004.11.

**EXCEPTION:** Fixtures on levels not required to be accessible.

**Fair Housing Accessibility Guidelines**

8/8/2016 10:04:11 AM

[www.zerostep.org](http://www.zerostep.org)

See Section [100.205\(c\)\(3\)\(i\)\(1\)](#), Section [100.205\(c\)\(3\)\(i\)\(2\)](#), Section [100.205\(c\)\(3\)\(i\)\(3\)](#), and Section [100.205\(c\)\(3\)\(i\)\(4\)](#).

## 2012 MI Building Code

### Section 1107 Dwelling Units and Sleeping Units

**1107.1 General.** In addition to the other requirements of this chapter, occupancies having dwelling units or sleeping units shall be provided with accessible features in accordance with this section.

**1107.2 Design.** Dwelling units and sleeping units that are required to be Accessible units, Type A units and Type B units shall comply with the applicable portions of Chapter 10 of ICC A117.1. Units required to be Type A units are permitted to be designed and constructed as Accessible units. Units required to be Type B units are permitted to be designed and constructed as Accessible units or as Type A units.

**1107.3 Accessible spaces.** Rooms and spaces available to the general public or available for use by residents and serving Accessible units, Type A units or Type B units shall be accessible. Accessible spaces shall include toilet and bathing rooms, kitchen, living and dining areas and any exterior spaces, including patios, terraces and balconies.

### Section 1109 Other Features and Facilities

**1109.2 Toilet and bathing facilities.** Each toilet room and bathing room shall be accessible. Where a floor level is not required to be connected by an accessible route, the only toilet rooms or bathing facilities provided within the facility shall not be located on the inaccessible floor. At least one of each type of fixture, element, control or dispenser in each accessible toilet room and bathing facility shall be accessible.

#### **EXCEPTIONS:**

- 1 In toilet rooms or bathing facilities accessed only through a private office, not for common or public use, and intended for use by a single occupant, any of the following alternatives are allowed:
  - 1.1 Doors are permitted to swing into the clear floor space provided the door swing can be reversed to meet the requirements in ICC A117.1,
  - 1.2 The height requirements for the water closet in ICC A 117.1 are not applicable,
  - 1.3 Grab bars are not required to be installed in a toilet room, provided that reinforcement has been installed in the walls and located so as to permit the installation of such grab bars, and
  - 1.4 The requirement for height, knee and toe clearance shall not apply to a lavatory.
2. This section is not applicable to toilet and bathing rooms that serve dwelling units or sleeping units that are not required to be accessible by Section 1107.
3. Where multiple single-user toilet rooms or bathing rooms are clustered at a single location, at least 50 percent but not less than one room for each use at each cluster, shall be accessible.
4. Where no more than one urinal is provided in a toilet room or bathing rooms, the urinal is not required to be accessible.
5. Toilet rooms that are part of critical-care or intensive-care patient sleeping rooms are not required to be accessible.
6. Where toilet facilities are primarily for children's use, required accessible water closets, toilet compartments and lavatories shall be permitted to comply with the children's provisions of ICC A117.1.

## 2015 MI Residential Code *(Nothing on Bathrooms - Locations.)*

**301.2 Turning Space.** There shall be a 5' diameter turning space. The turning space may overlap approaches at fixtures and doorway swings.

**ANSI A117.1 – 2009**

**603 Toilet and Bathing Rooms**

**603.1 General.** Accessible toilet and bathing rooms shall comply with Section 603.

**603.2 Clearances.**

**603.2.1 Turning Space.** A turning space complying with [Section 304](#) shall be provided within the room. The required turning space shall not be provided within a toilet compartment. (see [304.3.1](#))

**603.2.2 Door Swing.** Doors shall not swing into the clear floor space or clearance for any fixture.

**EXCEPTIONS:**

1. Doors to a toilet or bathing room for a single occupant, accessed only through a private office and not for common use or public use shall be permitted to swing into the clear floor space, provided the swing of the door can be reversed to comply with Section 603.2.2.
2. Where the room is for individual use and a clear floor space complying with [Section 305.3](#) is provided within the room beyond the arc of the door swing, the door shall not be required to comply with Section 603.2.2.

**ANSI A117.1 – 2009**

**1002 Accessible Units**

**1002.3 Accessible Route.** Accessible routes within Type A units shall comply with Section 1002.3.

**1002.11 Toilet and Bathing Facilities.** At least one toilet and bathing facility shall comply with Section 1002.11.2. All other toilet and bathing facilities shall comply with Section 1002.11.1. (See 603.2.1)

**603.2.1 Turning space.** A turning space complying with [Section 304](#) shall be provided within the room. The required turning space shall not be provided within a toilet compartment.

**ANSI A117.1 – 2009**

**1003 Type A Units**

**1003.3 Accessible Route.** Accessible routes within Type A units shall comply with Section 1003.3.

**1003.3.2 Turning Space.** All rooms served by an accessible route shall provide a turning space complying with [Section 304](#).

**EXCEPTIONS:**

1. A turning space is not required in toilet rooms and bathrooms that are not required to comply with Section 1003.11.2.
2. A turning space is not required within closets or pantries that are 48 inches (1220 mm) maximum in depth.

**1003.11.2 General.** At least one toilet and bathing facility shall comply with Section 1003.11.2. At least one lavatory, one water closet and either a bathtub or shower within the unit shall comply with Section 1003.11.2. The accessible toilet and bathing fixtures shall be in a single toilet/bathing area, such that travel between fixtures does not require travel through other parts of the unit.



**ANSI A117.1 – 2009**

**1004 Type B Units**

**1004.11 Toilet and Bathing Facilities.** Toilet and bathing fixtures shall comply with Section 1004.11.

**EXCEPTION:** Fixtures on levels not required to be accessible.

*(Nothing on Bathrooms – Turning Space.)*

**Fair Housing Accessibility Guidelines** *(Nothing on Bathrooms Turning space.)*

**2012 MI Building Code**

**Section 1107 Dwelling Units and Sleeping Units.**

**1107.3 Accessible Spaces.**

**1107.6.1.1.1 Accessible unit facilities.**

**EXCEPTION:**

1. Where multiple bathrooms are provided within an accessible unit, at least one full bathroom shall be accessible.

**See ZS 301.1 Bathrooms-Location.**

**2015 MI Residential Code** *(Nothing on Bathrooms - Turning Spaces.)*

**301.3 Clear Floor Space.** A 48" x 48" minimum clear floor space shall be provided at the sink, bathtub and shower. Only 19" of the 48" clear floor space may extend under the sink. The 48" x 48" clear floor spaces may overlap and include the toe kick space.

**EXCEPTION:** Where a 48" x 48" clear floor space cannot be provided, a 32" x 48" minimum clear floor space shall be permitted with two provisions: the 32" x 48" clear floor space must be positioned parallel to the fixtures and provide sufficient floor space to enlarge to a 48" x 48" clear floor space without moving perimeter bathroom walls. This will require changing fixtures or cabinetry.

**ANSI A117.1 – 2009**

**606 Lavatories and Sinks**

**606.1 General.** Accessible lavatories and sinks shall comply with Section 606.

**606.2 Clear Floor Space.** A clear floor space complying with Section ~~305.3~~, positioned for forward approach, shall be provided. Knee and toe clearance complying with Section 306 shall be provided. The dip of the overflow shall not be considered in determining knee and toe clearances.

**EXCEPTIONS:**

8/8/2016 10:04:11 AM

[www.zerostep.org](http://www.zerostep.org)

Appendix B: Code Comparisons 158

1. A parallel approach complying with [Section 305](#) and centered on the sink, shall be permitted to a kitchen sink in a space where a cook top or conventional range is not provided.
2. The requirement for knee and toe clearance shall not apply to a lavatory in a toilet or bathing facility for a single occupant, accessed only through a private office and not for common use or public use.
3. A knee clearance of 24 inches (610 mm) minimum above the floor shall be permitted at lavatories and sinks used primarily by children ages 6 through 12 where the rim or counter surface is 31 inches (785 mm) maximum above the floor.
4. A parallel approach complying with [Section 305](#) and centered on the sink, shall be permitted at lavatories and sinks used primarily by children ages 5 and younger.
5. The requirement for knee and toe clearance shall not apply to more than one bowl of a multibowl sink.
6. A parallel approach complying with [Section 305](#) and centered on the sink, shall be permitted at wet bars.

## 607 Bathtubs

**607.1 General.** Accessible bathtubs shall comply with Section 607.

**607.2 Clearance.** A clearance in front of bathtubs extending the length of the bathtub and 30 inches (760 mm) minimum in depth shall be provided. Where a permanent seat is provided at the head end of the bathtub, the clearance shall extend 12 inches (305 mm) minimum beyond the wall at the head end of the bathtub.

## 608 Shower Compartments

**608.1 General.** Accessible shower compartments shall comply with Section 608.

**608.2 Size, clearance and seat.** Shower compartments shall have sizes, clearances and seats complying with Section 608.2.

**608.2.1 Transfer-type Shower Compartments.** Transfer-type shower compartments shall comply with Section 608.2.1.

**608.2.1.1 Size.** Transfer-type shower compartments shall have a clear inside dimension of 36 inches (915 mm) in width and 36 inches (915 mm) in depth, measured at the center point of opposing sides. An entry 36 inches (915 mm) minimum in width shall be provided.

**608.2.1.2 Clearance.** A clearance of 48 inches (1220 mm) minimum in length measured perpendicular from the control wall, and 36 inches (915 mm) minimum in depth shall be provided adjacent to the open face of the compartment.

**608.2.2 Standard Roll-in-type Shower Compartments.** Standard roll-in-type shower compartments shall comply with Section 608.2.2.

**608.2.2.1 Size.** Standard roll-in-type shower compartments shall have a clear inside dimension of 60 inches (1525 mm) minimum in width and 30 inches (760 mm) minimum in depth, measured at the center point of opposing sides. An entry 60 inches (1525 mm) minimum in width shall be provided.

**608.2.2.2 Clearance.** A clearance of 60 inches (1525 mm) minimum in length adjacent to the 60-inch (1525 mm) width of the open face of the shower compartment, and 30 inches (760 mm) minimum in depth, shall be provided.

**EXCEPTION:** A lavatory complying with Section 606 shall be permitted at the end of the clearance

opposite the seat.

**608.2.3 Alternate Roll-in-type Shower Compartments.** Alternate roll-in-type shower compartments shall comply with Section 608.2.3.

**608.2.3.1 Size.** Alternate roll-in shower compartments shall have a clear inside dimension of 60 inches (1525 mm) minimum in width, and 36 inches (915 mm) in depth, measured at the center point of opposing sides. An entry 36 inches (915 mm) minimum in width shall be provided at one end of the 60-inch (1525 mm) width of the compartment. A seat wall, 24 inches (610 mm) minimum and 36 inches (915 mm) maximum in length, shall be provided on the entry side of the compartment.

(Nothing concerning a 36" x 36" size shower is also required in the same bathroom as a 30" x 60" minimum bathtub or bathing fixture.)

#### ANSI A117.1 – 2009

##### 1002 Accessible Units

**1002.11 Toilet and Bathing Facilities.** At least one toilet and bathing facility shall comply with Section 1002.11.2. All other toilet and bathing facilities shall comply with Section 1002.11.1. (See [605.2](#), [607.2](#), [608.2.1](#), [608.2.2](#), [608.2.3](#) and [305.3](#).)

#### ANSI A117.1 – 2009

##### 1003 Type A Units

**1003.11 Toilet and Bathing Facilities.** At least one toilet and bathing facility shall comply with Section 1003.11.2. All toilet and bathing facilities shall comply with Section 1003.11.1. (See Sections [1003.11.1](#), [1003.11.2](#), and [1003.11.3](#).)

**1003.11.1 Grab Bar and Shower Seat Reinforcement.** Reinforcement shall be provided for the future installation of grab bars complying with [Section 604.5](#) at water closets; grab bars complying with [Section 607.4](#) at bathtubs; and for grab bars and shower seats complying with [Sections 608.3](#), [608.2.1.3](#), [608.2.2.3](#) and [608.2.3.2](#) at shower compartments.

##### EXCEPTIONS:

1. At fixtures not required to comply with Section 1003.11.2, reinforcement in accordance with Section 1004.11.1 shall be permitted.
2. Reinforcement is not required in a room containing only a lavatory and a water closet, provided the room does not contain the only lavatory or water closet on the accessible level of the dwelling unit.
3. Reinforcement for the water closet side wall vertical grab bar component required by [Section 604.5](#) is not required.
4. Where the lavatory overlaps the water closet clearance in accordance with the exception to Section 1003.11.2.4.4 reinforcement at the water closet rear wall for a 24-inch (610 mm) minimum length grab bar, centered on the water closet, shall be provided.

**1003.11.2 General.** At least one toilet and bathing facility shall comply with Section 1003.11.2. At least one lavatory, one water closet and either a bathtub or shower within the unit shall comply with Section 1003.11.2. The accessible toilet and bathing fixtures shall be in a single toilet/bathing area, such that travel between fixtures does not require travel through other parts of the unit.

**1003.11.2.1 Doors.** Doors shall not swing into the clear floor space or clearance for any fixture.

**EXCEPTION:** Where a clear floor space complying with [Section 305.3](#) is provided within the room beyond the arc of the door swing.

**1003.11.2.4.4 Clearance Overlap.** The required clearance around the water closet shall be permitted to overlap the water closet, associated grab bars, paper dispensers, coat hooks, shelves, accessible routes, clear floor space required at other fixtures, and the wheelchair turning space. No other fixtures or obstructions shall be located within the required water closet clearance.

**EXCEPTION:** A lavatory measuring 24 inches (610 mm) maximum in depth and complying with Section 1003.11.2.2 shall be permitted on the rear wall 18 inches (455 mm) minimum from the centerline of the water closet to the side edge of the lavatory where the clearance at the water closet is 66 inches (1675 mm) minimum measured perpendicular from the rear wall.

#### ANSI A117.1 – 2009

##### 1004 Type B Units

**1004.11 Toilet and Bathing Facilities.** Toilet and bathing fixtures shall comply with Section 1004.11.

**EXCEPTION:** Fixtures on levels not required to be accessible.

**1004.11.3.1.3 Bathing Fixtures.** Where provided, a bathtub shall comply with Section 1004.11.3.1.3.1 or 1004.11.3.1.3.2 and a shower compartment shall comply with Section 1004.11.3.1.3.3.

**1004.11.3.1.3.1 Parallel Approach Bathtubs.** A clearance 60 inches (1525 mm) minimum in length and 30 inches (760 mm) minimum in width shall be provided in front of bathtubs with a parallel approach. Lavatories complying with [Section 606](#) shall be permitted in the clearance. A lavatory complying with Section 1004.11.3.1.1 shall be permitted at one end of the bathtub if a clearance 48 inches (1220 mm) minimum in length and 30 inches (760 mm) minimum in width is provided in front of the bathtub.

**1004.11.3.1.3.2 Forward Approach Bathtubs.** A clearance 60 inches (1525 mm) minimum in length and 48 inches (1220 mm) minimum in width shall be provided in front of bathtubs with a forward approach. A water closet and a lavatory shall be permitted in the clearance at one end of the bathtub.

**1004.11.3.1.3.3 Shower Compartment.** If a shower compartment is the only bathing facility, the shower compartment shall have dimensions of 36 inches (915 mm) minimum in width and 36 inches (915 mm) minimum in depth. A clearance of 48 inches (1220 mm) minimum in length, measured perpendicular from the shower head wall, and 30 inches (760 mm) minimum in depth, measured from the face of the shower compartment, shall be provided. Reinforcing for a shower seat is not required in shower compartments larger than 36 inches (915 mm) in width and 36 inches (915 mm) in depth.

##### Fair Housing Accessibility Guidelines

**Section 100.205(c)(3)(iv).** All bathrooms in the dwelling unit comply with the provisions of paragraph (a); or

At least one bathroom in the dwelling unit complies with the provisions of paragraph (b), and all other bathrooms and powder rooms within the dwelling unit must be on an accessible route with usable entry doors in accordance with the guidelines for Requirements 3 and 4.

However, in multistory dwelling units, only those bathrooms on the accessible level are subject to the requirements of section 100.205(c)(3)(iv). Where a powder room is the only facility provided on the accessible level of a multistory dwelling unit, the powder room must comply with provisions of paragraph (a) or paragraph (b). Powder rooms that are subject to the requirements of section 100.205(c)(3)(iv) must have reinforcements for grab bars as provided in the guideline for

Requirement 6.

**Section 100.205(c)(3)(iv)(a).** Bathrooms that have reinforced walls for grab bars (see Requirement 6) would meet section 100.205(c)(3)(iv) if:

**Section 100.205(c)(3)(iv)(a)(i).** Sufficient maneuvering space is provided within the bathroom for a person using a wheelchair or other mobility aid to enter and close the door, use the fixtures, reopen the door and exit. Doors may swing into the clear floor space provided at any fixture if the maneuvering space is provided. Maneuvering spaces may include any kneespace or toespace available below bathroom fixtures.

**Section 100.205(c)(3)(iv)(a)(ii)** Clear floor space is provided at fixtures as shown in Fig. 7(a), (b), (c) and (d). Clear floor space at fixtures may overlap.

**Section 100.205(c)(3)(iv)(a)(iii).** If the shower stall is the only bathing facility provided in the covered dwelling unit, the shower stall measures at least 36 inches x 36 inches.

**Note:**

Cabinets under lavatories are acceptable provided the bathroom has space to allow a parallel approach by a person in a wheelchair; if parallel approach is not possible within the space, any cabinets provided would have to be removable to afford the necessary knee clearance for forward approach.

**Section 100.205(c)(3)(iv)(b).** Bathrooms that have reinforced walls for grab bars (see Requirement 6) would meet section 100.205(c)(3)(iv) if:

**Section 100.205(c)(3)(iv)(b)(i).** Where the door swings into the bathroom, there is a clear space (approximately, 2'6" by 4'0") within the room to position a wheelchair or other mobility aid clear of the path of the door as it is closed and to permit use of fixtures. This clear space can include any kneespace and toespace available below bathroom fixtures.

**Section 100.205(c)(3)(iv)(b)(ii).** Where the door swings out, a clear space is provided within the bathroom for a person using a wheelchair or other mobility aid to position the wheelchair such that the person is allowed use of fixtures. There also shall be clear space to allow persons using wheelchairs to reopen the door to exit.

**Section 100.205(c)(3)(iv)(b)(iii).** When both tub and shower fixtures are provided in the bathroom, at least one is made accessible. When two or more lavatories in a bathroom are provided, at least one is made accessible.

**Section 100.205(c)(3)(iv)(b)(v).** Vanities and lavatories are installed with the centerline of the fixture a minimum of 1'3" horizontally from an adjoining wall or fixture. The top of the fixture rim is a maximum height of 2'10" above the finished floor. If kneespace is provided below the vanity, the bottom of the apron is at least 2'3" above the floor. If provided, full kneespace (for front approach) is at least 1'5" deep. (See Figure 7(c).)

**Section 100.205(c)(3)(iv)(b)(vi).** Bathtubs and tub/showers located in the bathroom provide a clear access aisle adjacent to the lavatory that is at least 2'6" wide and extends for a length of 4'0" (measured from the foot of the bathtub). (See Figure 8.)

**Section 100.205(c)(3)(iv)(b)(vii).** Stall showers in the bathroom may be of any size or configuration. A minimum clear floor space 2'6" wide by 4'0" should be available outside the stall. (See Figure 7(d).) If the shower stall is the only bathing facility provided in the covered dwelling unit, or on the accessible level of a covered multistory unit, and measures a minimal 36 x 36, the shower stall must have reinforcing to allow for installation of an optional wall hung bench seat.

#### 2012 MI Building Code

See Section 1107.2 Design.

#### 2015 MI Residential Code

##### Section 207 Toilet, Bath and Shower spaces.

**R307.1 Spaces Required.** Fixtures shall be spaced in accordance with Figure R307.1 and In accordance with the requirements of Section P2705.1.

**301.4 Toilet Clear Floor Space.** A clear floor space around the toilet of 48" minimum, measured perpendicular from the side wall, and 66" minimum, measured perpendicular from the rear wall, shall be provided. The required clearance around the toilet shall be permitted to overlap other fixture clear floor spaces.

**EXCEPTION:** Where a clear 48" x 66" clear floor space cannot be provided, a 32" x 48" minimum clear floor space shall be permitted with two provisions: the 32" x 48" clear floor space must be positioned parallel to the front of the toilet rim and provide sufficient floor space to enlarge to a 48" x 66" clear floor space without moving perimeter bathroom walls. This will require changing fixtures or cabinetry.

#### ANSI A117.1 – 2009

##### 604 Water Closets and Toilet Compartments

**604.3.1 Clearance width.** Clearance around a water closet shall be 60 inches (1525 mm) minimum in width, measured perpendicular from the sidewall.

**604.3.2 Clearance Depth.** Clearance around the water closet shall be 56 inches (1420 mm) minimum in depth, measured perpendicular from the rear wall.

**604.3.3 Clearance Overlap.** The required clearance around the water closet shall be permitted to overlap the water closet, associated grab bars, paper dispensers, sanitary napkin receptacles, coat hooks, shelves, accessible routes, clear floor space at other fixtures and the turning space. No other fixtures or obstructions shall be within the required water closet clearance.

##### 604.9 Wheelchair Accessible Compartments.

**604.9.1 General.** Wheelchair accessible compartments shall comply with Section 604.9.

**604.9.2 Size.** Toilet compartments shall comply with Section 604.9.2.1 or 604.9.2.2 as applicable.

#### ANSI A117.1 – 2009

##### 1002 Accessible Units

**1002.11 Toilet and Bathing Facilities.** At least one toilet and bathing facility shall comply with Section 1002.11.2. All other toilet and bathing facilities shall comply with Section 1002.11.1

#### ANSI A117.1 – 2009

##### 1003 Type A Units

8/8/2016 10:04:11 AM

[www.zerostep.org](http://www.zerostep.org)

**1003.11 Toilet and Bathing Facilities.** At least one toilet and bathing facility shall comply with Section 1003.11.2. All toilet and bathing facilities shall comply with Section 1003.11.1.

**1003.11.1 Grab Bar and Shower Seat Reinforcement.** Reinforcement shall be provided for the future installation of grab bars complying with [Section 604.5](#) at water closets; grab bars complying with [Section 607.4](#) at bathtubs; and for grab bars and shower seats complying with [Sections 608.3](#), [608.2.1.3](#), [608.2.2.3](#) and [608.2.3.2](#) at shower compartments.

**EXCEPTIONS:**

1. At fixtures not required to comply with Section 1003.11.2, reinforcement in accordance with Section 1004.11.1 shall be permitted.
2. Reinforcement is not required in a room containing only a lavatory and a water closet, provided the room does not contain the only lavatory or water closet on the accessible level of the dwelling unit.
3. Reinforcement for the water closet side wall vertical grab bar component required by [Section 604.5](#) is not required.
4. Where the lavatory overlaps the water closet clearance in accordance with the exception to Section 1003.11.2.4.4 reinforcement at the water closet rear wall for a 24-inch (610 mm) minimum length grab bar, centered on the water closet, shall be provided.

**1003.11.2 General.** At least one toilet and bathing facility shall comply with Section 1003.11.2. At least one lavatory, one water closet and either a bathtub or shower within the unit shall comply with Section 1003.11.2. The accessible toilet and bathing fixtures shall be in a single toilet/bathing area, such that travel between fixtures does not require travel through other parts of the unit.

**1003.11.2.1 Doors.** Doors shall not swing into the clear floor space or clearance for any fixture.

**EXCEPTION:** Where a clear floor space complying with [Section 305.3](#) is provided within the room beyond the arc of the door swing.

**1003.11.2.4.4 Clearance Overlap.** The required clearance around the water closet shall be permitted to overlap the water closet, associated grab bars, paper dispensers, coat hooks, shelves, accessible routes, clear floor space required at other fixtures, and the wheelchair turning space. No other fixtures or obstructions shall be located within the required water closet clearance.

**EXCEPTION:** A lavatory measuring 24 inches (610 mm) maximum in depth and complying with Section 1003.11.2.2 shall be permitted on the rear wall 18 inches (455 mm) minimum from the centerline of the water closet to the side edge of the lavatory where the clearance at the water closet is 66 inches (1675 mm) minimum measured perpendicular from the rear wall..

**ANSI A117.1 – 2009**

**1004 Type B Units**

**1004.11 Toilet and Bathing Facilities.** Toilet and bathing fixtures shall comply with Section 1004.11.

**EXCEPTION:** Fixtures on levels not required to be accessible.

**1004.11.1 Grab Bar and Shower Seat Reinforcement.** Reinforcement shall be provided for the future installation of grab bars and shower seats at water closets, bathtubs, and shower compartments. Where walls are located to permit the installation of grab bars and seats complying with [Section 604.5](#) at water closets; grab bars complying

with [Section 607.4](#) at bathtubs; and for grab bars and shower seats complying with Sections, 608.3, 608.2.1.3, 608.2.2.3 and 608.2.3.2 at shower compartments; reinforcement shall be provided for the future installation of grab bars and seats complying with those requirements.

**EXCEPTIONS:**

1. In a room containing only a lavatory and a water closet, reinforcement is not required provided the room does not contain the only lavatory or water closet on the accessible level of the unit.
2. At water closets reinforcement for the side wall vertical grab bar component required by [Section 604.5](#) is not required.
3. At water closets where wall space will not permit a grab bar complying with [Section 604.5.2](#), reinforcement for a rear wall grab bar 24 inches (610 mm) minimum in length centered on the water closet shall be provided.
4. At water closets where a side wall is not available for a 42-inch (1065 mm) grab bar complying with [Section 604.5.1](#), reinforcement for a sidewall grab bar, 24 inches (610 mm) minimum in length, located 12 inches (305 mm) maximum from the rear wall, shall be provided.
5. At water closets where a side wall is not available for a 42-inch (1065 mm) grab bar complying with [Section 604.5.1](#) reinforcement for a swing-up grab bar complying with Section 1004.11.1.1 shall be permitted.
6. At water closets where a side wall is not available for a 42-inch (1065 mm) grab bar complying with [Section 604.5.1](#) reinforcement for two swing-up grab bars complying with Section 1004.11.1.1 shall be permitted to be installed in lieu of reinforcement for rear wall and side wall grab bars.
7. In shower compartments larger than 36 inches (915 mm) in width and 36 inches (915 mm) in depth reinforcement for a shower seat is not required

**1004.11.1.1 Doors.** Doors shall not swing into the clear floor space for any fixture.

**EXCEPTION:** Where a clear floor space complying with Section [305.3](#), excluding knee and toe clearances under elements, is provided within the room beyond the arc of the door swing.

**1004.11.2 Clear Floor Space.** Clear floor spaces required by Section 1004.11.3.1 (Option A) or 1004.11.3.2 (Option B) shall comply with Sections 1004.11.2 and [305.3](#).

**1004.11.2.1 Doors.** Doors shall not swing into the clear floor space or clearance for any fixture.

**EXCEPTION:** Where a clear floor space complying with [Section 305.3](#), excluding knee and toe clearances under elements, is provided within the room beyond the arc of the door swing.

**1004.11.3.1.2 Water Closet.** The water closet shall comply with Section 1004.11.3.1.2.

**1004.11.3.1.2.1 Location.** The centerline of the water closet shall be 16 inches (405 mm) minimum and 18 inches (455 mm) maximum from one side of the required clearance.

**1004.11.3.1.2.2 Clearance.** Clearance around the water closet shall comply with Sections 1004.11.3.1.2.2.1 through 1004.11.3.1.2.2.3.

**EXCEPTION:** Clearance complying with Sections 1003.11.2.4.2 through 1003.11.2.4.4.

**1004.11.3.1.2.2.1 Clearance Width.** Clearance around the water closet shall be 48 inches (1220 mm) minimum in width, measured perpendicular from the side of the clearance that



is 16 inches (405 mm) minimum and 18 inches (455 mm) maximum from the water closet centerline.

**1004.11.3.1.2.2.2 Clearance Depth.** Clearance around the water closet shall be 56 inches (1420 mm) minimum in depth, measured perpendicular from the rear wall.

**1004.11.3.1.2.2.3 Increased Clearance Depth at Forward Approach.** Where a forward approach is provided, the clearance shall be 66 inches (1675 mm) minimum in depth, measured perpendicular from the rear wall.

**1004.11.3.1.2.2.4 Clearance Overlap.** A vanity or other obstruction 24 inches (610 mm) maximum in depth, measured perpendicular from the rear wall, shall be permitted to overlap the required clearance, provided the width of the remaining clearance at the water closet is 33 inches (840 mm) minimum.

#### Fair Housing Accessibility Guidelines

**Section 100.205(c)(3)(iv)(b)(iv).** Toilets are located within bathrooms in a manner that permit a grab bar to be installed on one side of the fixture. In locations where toilets are adjacent to walls or bathtubs, the center line of the fixture is a minimum of 1'6" from the obstacle. The other (non-grab bar) side of the toilet fixture is a minimum of 1'3" from the finished surface of adjoining walls, vanities or from the edge of a lavatory. (See Figure 7(a).)

#### 2012 MI Building Code

See Section [1107.2](#) Design.

#### 2015 MI Residential Code

##### Section 207 Toilet, Bath and Shower spaces.

**R307.1 Spaces Required.** Fixtures shall be spaced in accordance with Figure R307.1 and in accordance with the requirements of Section P2705.1.

**301.5 Doors.** Doors shall comply with [Section 201](#).

#### ANSI A117.1 – 2009

##### 1002 Accessible Units

**1002.5 Doors and Doorways.** The primary entrance door to the dwelling unit, and all other doorways intended for user passage, shall comply with Section 404. (See [404.1](#), [404.2](#), [404.2.1](#), [404.2.2](#), [404.2.3.1](#), [404.2.3.2](#), [404.2.3.3](#), [404.2.3.4](#), [404.2.3.5](#), [404.2.4](#), and [404.3.3](#).)

##### EXCEPTIONS:

1. Existing doors to hospital patient sleeping rooms shall be exempt from the requirement for space at the latch side provided the door is 44 inches (1120 mm) minimum in width.
2. In toilet rooms and bathrooms not required to comply with Section 1002.11.2, maneuvering clearances required by [Section 404.2.3](#) are not required on the toilet room or bathroom side of the door.
3. A turning space between doors in a series as required by [Section 404.2.5](#) is not required.
4. Storm and screen doors are not required to comply with [Section 404.2.5](#).

8/8/2016 10:04:11 AM

[www.zerostep.org](http://www.zerostep.org)

Appendix B: Code Comparisons 166

5. Communicating doors between individual sleeping units are not required to comply with [Section 404.2.5](#).
6. At other than the primary entrance door, where exterior space dimensions of balconies are less than the required maneuvering clearance, door maneuvering clearance is not required on the exterior side of the door.

#### ANSI A117.1 – 2009

##### 1003 Type A Units

**1003.5 Doors and Doorways.** The primary entrance door to the dwelling unit, and all other doorways intended for user passage, shall comply with Section 404. (See [404.1](#), [404.2](#), [404.2.1](#), [404.2.2](#), [404.2.3.1](#), [404.2.3.2](#), [404.2.3.3](#), [404.2.3.4](#), [404.2.3.5](#), [404.2.4](#), and [404.3.3](#).)

##### EXCEPTIONS:

1. Thresholds at exterior sliding doors shall be permitted to be  $\frac{3}{4}$  inch (19 mm) maximum in height, provided they are beveled with a slope not greater than 1:2.
2. In toilet rooms and bathrooms not required to comply with Section 1003.11.2, maneuvering clearances required by [Section 404.2.3](#) are not required on the toilet room or bathroom side of the door.
3. A turning space between doors in a series as required by [Section 404.2.5](#) is not required.
4. Storm and screen doors are not required to comply with [Section 404.2.5](#).
5. Communicating doors between individual sleeping units are not required to comply with [Section 404.2.5](#).
6. At other than the primary entrance door, where exterior space dimensions of balconies are less than the required maneuvering clearance, door maneuvering clearance is not required on the exterior side of the door.

**1003.11 Toilet and Bathing Facilities.** At least one toilet and bathing facility shall comply with Section 1003.11.2. All toilet and bathing facilities shall comply with Section 1003.11.1.

**1003.11.1 Grab Bar and Shower Seat Reinforcement.** Reinforcement shall be provided for the future installation of grab bars complying with [Section 604.5](#) at water closets; grab bars complying with [Section 607.4](#) at bathtubs; and for grab bars and shower seats complying with [Sections 608.3](#), [608.2.1.3](#), [608.2.2.3](#) and [608.2.3.2](#) at shower compartments.

##### EXCEPTIONS:

1. At fixtures not required to comply with Section 1003.11.2, reinforcement in accordance with Section 1004.11.1 shall be permitted.
2. Reinforcement is not required in a room containing only a lavatory and a water closet, provided the room does not contain the only lavatory or water closet on the accessible level of the dwelling unit.
3. Reinforcement for the water closet side wall vertical grab bar component required by [Section 604.5](#) is not required.
4. Where the lavatory overlaps the water closet clearance in accordance with the exception to Section 1003.11.2.4.4 reinforcement at the water closet rear wall for a 24-inch (610 mm) minimum length grab bar, centered on the water closet, shall be provided.

**1003.11.2 General.** At least one toilet and bathing facility shall comply with Section 1003.11.2. At least one lavatory, one water closet and either a bathtub or shower within the unit shall comply with Section 1003.11.2. The accessible toilet and bathing fixtures shall be in a single toilet/bathing area, such that travel between fixtures does not require travel through other parts of the unit.

**1003.11.2.1 Doors.** Doors shall not swing into the clear floor space or clearance for any fixture.

**EXCEPTION:** Where a clear floor space complying with [Section 305.3](#) is provided within the room beyond the arc of the door swing.

**ANSI A 117.1 – 2003**

**1004 Type B Units**

**1004.5 Doors and Doorways.** Doors and doorways shall comply with Section 1004.5. (See [1004.5.2](#), [1004.5.2.1](#), [1004.5.2.2](#), [1004.5.2.3](#), and [1004.5.2.4](#).)

**1004.11 Toilet and Bathing Facilities.** Toilet and bathing fixtures shall comply with Section 1004.11.

**EXCEPTION:** Fixtures on levels not required to be accessible.

**1004.11.2.1 Doors.** Doors shall not swing into the clear floor space for any fixture.

**EXCEPTION:** Where a clear floor space complying with Section [305.3](#), excluding knee and toe clearances under elements, is provided within the room beyond the arc of the door swing.

**Fair Housing Accessibility Guidelines**

See Section [100.205\(c\)\(2\)\(2\)](#).

**2012 MI Building Code**

See Section [1008.1](#) and [1008.1.1](#).

See Section [1107.2](#) Design.

**2015 MI Residential Code** (*Nothing on Bathroom - Doors.*)

**301.6 Wall Reinforcement.** Walls shall be reinforced with 2x blocking concealed in the wall for future grab bar placement around toilets, bathtubs, showers and for slide bar, hand held showers. Allowable stresses shall not be exceeded for materials used where a vertical or horizontal force of 250 pounds is applied at any point when grab bars are installed.

**ANSI A117.1 – 2009** (Sections concerning grab bars and hand showers are noted here in order to provide guidance on where blocking needs to be placed.)

**604 Water Compartments and Toilet compartments**

**604.5 Grab Bars.** Grab bars for water closets shall comply with Section 609 and shall be provided in accordance with Sections 604.5.1 and 604.5.2. Grab bars shall be provided on the rear wall and on the side wall closest to the water closet.

**EXCEPTIONS:**

1. Grab bars are not required to be installed in a toilet room for a single occupant, accessed only through a private office and not for common use or public use, provided reinforcement has been installed in walls and located so as to permit the installation of grab bars complying with Section 604.5.
2. In detention or correction facilities, grab bars are not required to be installed in housing or holding cells or rooms that are specially designed without protrusions for purposes of suicide prevention.

**604.5.1 Fixed Side Wall Grab Bars.** Fixed side-wall grab bars shall be 42 inches (1065 mm) minimum in length, located 12 inches (305 mm) maximum from the rear wall and extending 54 inches (1370 mm) minimum from the rear

wall. In addition, a vertical grab bar 18 inches (455 mm) minimum in length shall be mounted with the bottom of the bar located 39 inches (990 mm) minimum and 41 inches (1040 mm) maximum above the floor, and with the center line of the bar located 39 inches (990 mm) minimum and 41 inches (1040 mm) maximum from the rear wall.

**EXCEPTION:** The vertical grab bar at water closets primarily for children's use shall comply with Section 609.4.2.

**604.5.2 Rear Wall Grab Bars.** The rear wall grab bar shall be 36 inches (915 mm) minimum in length, and extend from the centerline of the water closet 12 inches (305 mm) minimum on the side closest to the wall, and 24 inches (610 mm) minimum on the transfer side.

**EXCEPTIONS:**

1. The rear grab bar shall be permitted to be 24 inches (610 mm) minimum in length, centered on the water closet, where wall space does not permit a grab bar 36 inches (915 mm) minimum in length due to the location of a recessed fixture adjacent to the water closet.
2. Where an administrative authority requires flush controls for flush valves to be located in a position that conflicts with the location of the rear grab bar, that grab bar shall be permitted to be split or shifted to the open side of the toilet area.

## 607 Bathtubs

**607.4 Grab Bars.** Grab bars shall comply with Section 609 and shall be provided in accordance with Section 607.4.1 or 607.4.2.

**EXCEPTION:** Grab bars shall not be required to be installed in a bathing facility for a single occupant accessed only through a private office and not for common use or public use, provided reinforcement has been installed in walls and located so as to permit the installation of grab bars complying with Section 607.4.

**607.4.1 Bathtubs with Permanent Seats.** For bathtubs with permanent seats, grab bars complying with Section 607.4.1 shall be provided.

**607.4.1.1 Back Wall.** Two horizontal grab bars shall be provided on the back wall, one complying with Section 609.4 and the other located 8 inches (205 mm) minimum and 10 inches (255 mm) maximum above the rim of the bathtub. Each grab bar shall be located 15 inches (380 mm) maximum from the head end wall and extend to 12 inches (305 mm) maximum from the control end wall.

**607.4.1.2 Control End Wall.** Control end wall grab bars shall comply with Section 607.4.1.2.

**EXCEPTION:** An L-shaped continuous grab bar of equivalent dimensions and positioning shall be permitted to serve the function of separate vertical and horizontal grab bars.

**607.4.1.2.1 Horizontal Grab Bar.** A horizontal grab bar 24 inches (610 mm) minimum in length shall be provided on the control end wall beginning near the front edge of the bathtub and extending toward the inside corner of the bathtub..

**607.4.1.2.2 Vertical Grab Bar.** A vertical grab bar 18 inches (455 mm) minimum in length shall be provided on the control end wall 3 inches (75 mm) minimum and 6 inches (150 mm) maximum above the horizontal grab bar, and 4 inches (100 mm) maximum inward from the front edge of the bathtub.

**607.4.2 Bathtubs without Permanent Seats.** For bathtubs without permanent seats, grab bars complying with Section 607.4.2 shall be provided.

**607.4.2.1 Back Wall.** Two horizontal grab bars shall be provided on the back wall, one complying with Section 609.4 and the other located 8 inches (205 mm) minimum and 10 inches (255 mm) maximum above the rim of the bathtub. Each grab bar shall be 24 inches (610 mm) minimum in length, located 24 inches (610 mm) maximum from the head end wall and extend to 12 inches (305 mm) maximum from the control end wall.

**607.4.2.2 Control End Wall.** Control end wall grab bars shall comply with Section 607.4.1.2.

**607.4.2.3 Head End Wall.** A horizontal grab bar 12 inches (305 mm) minimum in length shall be provided on the head end wall at the front edge of the bathtub.

## 608 Shower Compartments

**608.3 Grab Bars.** Grab bars shall comply with Section 609 and shall be provided in accordance with Section 608.3. Where multiple grab bars are used, required horizontal grab bars shall be installed at the same height above the floor.

**EXCEPTION:** Grab bars are not required to be installed in a shower for a single occupant, accessed only through a private office and not for common use or public use, provided reinforcement has been installed in walls and located so as to permit the installation of grab bars complying with Section 608.3.

**608.3.1 Transfer-Type showers.** Grab bars for transfer type showers shall comply with Section 608.3.1.

**608.3.1.1 Horizontal Grab Bars.** Horizontal grab bars shall be provided across the control wall and on the back wall to a point 18 inches (455 mm) from the control wall.

**608.3.1.2 Vertical Grab Bar.** A vertical grab bar 18 inches (455 mm) minimum in length shall be provided on the control end wall 3 inches (75 mm) minimum to 6 inches (150 mm) maximum above the horizontal grab bar, and 4 inches (100 mm) maximum inward from the front edge of the shower.

**608.3.2 Standard Roll-in-Type Showers.** In standard roll-in type showers, a grab bar shall be provided on the back wall beginning at the edge of the seat. The grab bars shall not be provided above the seat. The back wall grab bar shall extend the length of the wall but shall not be required to exceed 48 inches (1220 mm) in length. Where a side wall is provided opposite the seat within 72 inches (1830 mm) of the seat wall, a grab bar shall be provided on the side wall opposite the seat. The side wall grab bar shall extend the length of the wall but shall not be required to exceed 30 inches (760 mm) in length. Grab bars shall be 6 inches (150 mm) maximum from the adjacent wall.

**608.3.3 Alternate Roll-in type showers.** In alternate roll-in type showers, grab bars shall be provided on the back wall and the end wall adjacent to the seat. Grab bars shall not be provided above the seat. Grab bars shall be 6 inches (150 mm) maximum from the adjacent wall.

**608.2.1.3 Seat.** A folding or non-folding seat complying with Section 610 shall be provided on the wall opposite the control wall.

**EXCEPTION:** A seat is not required to be installed in a shower for a single occupant, accessed only through a private office and not for common use or public use, provided reinforcement has been installed in walls and located so as to permit the installation of a shower seat.

**608.4 Controls and Hand Showers.** Controls and hand showers shall comply with Sections 608.4 and 309.4.

**608.4.1 Transfer-Type Showers.** In transfer-type showers, the controls and hand shower shall be located:

1. On the control wall opposite the seat.
2. At a height of 38 inches (965 mm) minimum and 48 inches (1220 mm) maximum above the shower floor, and
3. 15 inches (380 mm) maximum, from the centerline of the control wall toward the shower opening.

**608.4.2 Standard Roll-in Showers.** In standard roll-in showers, the controls and hand shower shall be located on the back wall above the grab bar, 48 inches (1220 mm) maximum above the shower floor and 16 inches (405 mm) minimum and 27 inches (685 mm) maximum from the end wall behind the seat.

**608.4.3 Alternate Roll-in Showers.** In alternate roll-in showers, the controls and hand shower shall be located 38 inches (965 mm) minimum and 48 inches (1220 mm) maximum above the shower floor. In alternate roll-in showers with controls and hand shower located on the end wall adjacent to the seat, the controls and hand shower shall be 27 inches (685 mm) maximum from the seat wall. In alternate roll-in showers with the controls and hand shower located on the back wall opposite the seat, the controls and hand shower shall be located within 15 inches (380 mm), left or right, of the centerline of the seat.

**608.5 Hand Showers.** A hand shower with a hose 59 inches (1500 mm) minimum in length that can be used both as a fixed shower head and as a hand shower, shall be provided. The hand shower shall have a control with a nonpositive shut-off feature. Where provided, an adjustable-height hand shower mounted on a vertical bar shall be installed so as to not obstruct the use of grab bars.

**EXCEPTION:** In other than Accessible units and Type A units, a fixed shower head located 48 inches (1220 mm) maximum above the shower floor shall be permitted in lieu of a hand shower.

## 609 Grab Bars

### 609.4 Position of Grab Bars.

**609.4.1 General.** Grab bars shall be installed in a horizontal position, 33 inches (840 mm) minimum and 36 inches (915 mm) maximum above the floor measured to the top of the gripping surface or shall be installed as required by Items 1 through 3.

1. The lower grab bar on the back wall of a bathtub shall comply with Section 607.4.1.1 or 607.4.2.1.
2. Vertical grab bars shall comply with Sections 604.5.1, 607.4.1.2.2, 607.4.2.2, and 608.3.1.2.
3. Grab bars at water closets primarily for children's use shall comply with Section 609.4.2.

## ANSI A117.1 – 2009

### 1002 Accessible Units

**1002.11 Toilet and Bathing Facilities.** At least one toilet and bathing facility shall comply with Section 1002.11.2. All other toilet and bathing facilities shall comply with Section 1002.11.1. (See [604.5](#), [607.4](#), [608.3](#) and [608.4](#).)

**1002.11.1 Grab Bars and Shower Seat Reinforcement.** At fixtures in toilet and bathing facilities not required to comply with Section 1002.11.2, reinforcement in accordance with Section 1004.11.1 shall be provided.

**EXCEPTION:** Reinforcement is not required where Type B units are not provided in the structure.

**1002.11.2 Accessible Toilet and Bathing Facility.** At least one toilet and bathing facility shall comply with [Section](#)

[603](#). At least one lavatory, one water closet and either a bathtub or shower within the unit shall comply with [Sections 604](#) through [610](#). The accessible toilet and bathing fixtures shall be in a single toilet/bathing area, such that travel between fixtures does not require travel through other parts of the unit.

#### ANSI A117.1 – 2009

##### 1003 Type A Units

**1003.11 Toilet and Bathing Facilities.** At least one toilet and bathing facility shall comply with Section 1003.11.2. All toilet and bathing facilities shall comply with Section 1003.11.1.

**1003.11.1 Grab Bar and Shower Seat Reinforcement.** Reinforcement shall be provided for the future installation of grab bars complying with [Section 604.5](#) at water closets; grab bars complying with [Section 607.4](#) at bathtubs; and for grab bars and shower seats complying with [Sections 608.3](#), [608.2.1.3](#), [608.2.2.3](#) and [608.2.3.2](#) at shower compartments.

##### EXCEPTIONS:

1. At fixtures not required to comply with Section 1003.11.2, reinforcement in accordance with Section 1004.11.1 shall be permitted.
2. Reinforcement is not required in a room containing only a lavatory and a water closet, provided the room does not contain the only lavatory or water closet on the accessible level of the dwelling unit.
3. Reinforcement for the water closet side wall vertical grab bar component required by [Section 604.5](#) is not required.
4. Where the lavatory overlaps the water closet clearance in accordance with the exception to Section 1003.11.2.4.4 reinforcement at the water closet rear wall for a 24-inch (610 mm) minimum length grab bar, centered on the water closet, shall be provided.

#### ANSI A 117.1 – 2003

##### 1004 Type B Units

**1004.11 Toilet and Bathing Facilities.** Toilet and bathing fixtures shall comply with Section 1004.11.

**EXCEPTION:** Fixtures on levels not required to be accessible.

**1004.11.1 Grab Bar and Shower Seat Reinforcement.** Reinforcement shall be provided for the future installation of grab bars and shower seats at water closets, bathtubs, and shower compartments. Where walls are located to permit the installation of grab bars and seats complying with [Section 604.5](#) at water closets; grab bars complying with [Section 607.4](#) at bathtubs; and for grab bars and shower seats complying with Sections, 608.3, 608.2.1.3, 608.2.2.3 and 608.2.3.2 at shower compartments; reinforcement shall be provided for the future installation of grab bars and seats complying with those requirements.

##### EXCEPTIONS:

1. In a room containing only a lavatory and a water closet, reinforcement is not required provided the room does not contain the only lavatory or water closet on the accessible level of the unit.
2. At water closets reinforcement for the side wall vertical grab bar component required by [Section 604.5](#) is not required.
3. At water closets where wall space will not permit a grab bar complying with [Section 604.5.2](#), reinforcement for a rear wall grab bar 24 inches (610 mm) minimum in length centered on the water closet shall be provided.

4. At water closets where a side wall is not available for a 42-inch (1065 mm) grab bar complying with [Section 604.5.1](#), reinforcement for a sidewall grab bar, 24 inches (610 mm) minimum in length, located 12 inches (305 mm) maximum from the rear wall, shall be provided.
5. At water closets where a side wall is not available for a 42-inch (1065 mm) grab bar complying with [Section 604.5.1](#) reinforcement for a swing-up grab bar complying with Section 1004.11.1.1 shall be permitted.
6. At water closets where a side wall is not available for a 42-inch (1065 mm) grab bar complying with [Section 604.5.1](#) reinforcement for two swing-up grab bars complying with Section 1004.11.1.1 shall be permitted to be installed in lieu of reinforcement for rear wall and side wall grab bars.
7. In shower compartments larger than 36 inches (915 mm) in width and 36 inches (915 mm) in depth reinforcement for a shower seat is not required

#### Fair Housing Accessibility Guidelines

**Section 100.205(c)(3)(iii)** requires that covered multifamily dwellings with a building entrance on an accessible route shall be designed and constructed in such a manner that all premises within covered multifamily dwelling units contain reinforcements in bathroom walls to allow later installation of grab bars around toilet, tub, shower stall and shower seat, where such facilities are provided.

#### Guideline

Reinforced bathroom walls to all later installation of grab bars around the toilet, tub, shower stall, and shower seat, where facilities are provided, would meet section 100.205(c)(3)(iii) if reinforced areas are provided at least at those points where grab bars will be mounted. (For example, see Figs. 3, 4 and 5.) Where the toilet is not placed adjacent to a side wall, the bathroom would comply if provision was made for installation of floor mounted, foldaway or similar alternative grab bars. Where the powder room (a room with a toilet and sink) is the only toilet facility located on an accessible level of a multistory dwelling unit, it must comply with this requirement for reinforced walls for grab bars.

#### Note:

Installation of bathtubs is not limited by the illustrative figures; a tub may have shelves or benches at either end; or a tub may be installed without surrounding walls, if there is a provision for alternative mounting of grab bars. For example, a sunken tub placed away from walls could have reinforced areas for installation of floor-mounted grab bars. The same principle applies to shower stalls – e.g., glass walled stalls could be planned to allow floor-mounted grab bars to be installed later.

Reinforcement for grab bars may be provided in a variety of ways (for example, by plywood or wood blocking) so long as the necessary reinforcement is placed so as to permit later installation of appropriate grab bars.

#### 2012 MI Building Code

##### Section 1109 Other Features and Facilities.

**1109.2 Toilet and bathing facilities.** Each toilet room and bathing room shall be accessible. Where a floor level is not required to be connected by an accessible route, the only toilet rooms or bathing facilities provided within the facility shall not be located on the inaccessible floor. At least one of each type of fixture, element, control or dispenser in each accessible toilet room and bathing facility shall be accessible.

#### **EXCEPTIONS:**

- 1.3 Grab bars are not required to be installed in a toilet room, provided that reinforcement has been installed in the walls and located so as to permit the installation of such grab bars, and



2015 MI Residential Code (Nothing on Bathrooms - Wall Reinforcement.)

**301.7 Wall Reinforcement Documentation.** Wall reinforcement documentation for installation of future grab bars is provided.

ANSI A117.1 – 2009

1002 Accessible Units (Nothing on Bathrooms – Wall Reinforcement Document.)

ANSI A117.1 – 2009

1003 Type A Units (Nothing on Bathrooms – Wall Reinforcement Document.)

ANSI A117.1 – 2009

1004 Type B Units (Nothing on Bathrooms – Wall Reinforcement Document.)

Fair Housing Accessibility Guidelines (Nothing on Bathrooms – Wall Reinforcement Document.)

2009 MI Building Code (Nothing on Bathrooms – Wall Reinforcement Document.)

2009 MI Residential Code (Nothing on Bathrooms – Wall Reinforcement Document.)

**301.8 Bathtub / Shower Stall 12" Deep Clear Floor Space.** A 12" minimum clear floor space shall be provided along the entire length of a bathtub and/or a shower stall according to Table 301.10.

ANSI A117.1 – 2009

607 Bathtubs

607.1 General. Accessible bathtubs shall comply with Section 607. (See [607.2](#).)

ANSI A117.1 – 2009

1002 Accessible Units

1002.11 Toilet and Bathing Facilities. At least one toilet and bathing facility shall comply with Section 1002.11.2. All other toilet and bathing facilities shall comply with Section 1002.11.1

1002.11.1 Grab Bars and Shower Seat Reinforcement. At fixtures in toilet and bathing facilities not required to comply with Section 1002.11.2, reinforcement in accordance with Section 1004.11.1 shall be provided.

**EXCEPTION:** Reinforcement is not required where Type B units are not provided in the structure.

1002.11.2 Accessible Toilet and Bathing Facility. At least one toilet and bathing facility shall comply with [Section 603](#). At least one lavatory, one water closet and either a bathtub or shower within the unit shall comply with [Sections 604](#) through [610](#). The accessible toilet and bathing fixtures shall be in a single toilet/bathing area, such that travel between fixtures does not require travel through other parts of the unit.

ANSI A117.1 – 2009

1003 Type A Units

8/8/2016 10:04:11 AM

[www.zerostep.org](http://www.zerostep.org)

Appendix B: Code Comparisons 174

**1003.11.2 General.** At least one toilet and bathing facility shall comply with Section 1003.11.2. At least one lavatory, one water closet and either a bathtub or shower within the unit shall comply with Section 1003.11.2. The accessible toilet and bathing fixtures shall be in a single toilet/bathing area, such that travel between fixtures does not require travel through other parts of the unit.

**1003.11.2.5.1 Bathtub.** Bathtubs shall comply with [Section 607](#). (See [607.2](#).)

**EXCEPTIONS:**

1. The removable in-tub seat required by [Section 607.3](#) is not required.
2. Counter tops and cabinetry shall be permitted at one end of the clearance, provided the following criteria are met:
  - (a) The countertop and cabinetry can be removed;
  - (b) The floor finish extends under the countertop and cabinetry; and
  - (c) The walls behind and surrounding the countertop and cabinetry are finished.

**ANSI A 117.1 – 2003**

**1004 Type B Units**

**1004.11 Toilet and Bathing Facilities.** Toilet and bathing fixtures shall comply with Section 1004.11.

**EXCEPTION:** Fixtures on levels not required to be accessible.

**1004.11.3.2.3.1 Bathtub.** A clearance 48 inches (1220 mm) minimum in length measured perpendicular from the control end of the bathtub, and 30 inches (760 mm) minimum in width shall be provided in front of bathtubs.

**Fair Housing Accessibility Guidelines**

**Usable bathroom.**

(vi) Bathtubs and tub/showers located in the bathroom provide a clear access aisle adjacent to the lavatory that is at least 2'6" wide and extends for a length of 4'0" (measured from the foot of the bathtub). (See Figure 8.)

**2012 MI Building Code** (*Nothing on Bathtub – Clear Floor Space.*)

**2015 MI Residential Code**

**Section 207 Toilet, Bath and Shower spaces.**

**R307.1 Spaces Required.** Fixtures shall be spaced in accordance with Figure R307.1 and In accordance with the requirements of Section P2705.1.

**301.9 Bathtub Height.** On-slab construction shall not increase the height of the bathtub.

**ANSI A117.1 – 2009**

**1002 Accessible Units** (*Nothing on Bathtub Height.*)

**ANSI A117.1 – 2009**

**1003 Type A Units** (*Nothing on Bathtub Height.*)

**ANSI A117.1 – 2009**

8/8/2016 10:04:11 AM

[www.zerostep.org](http://www.zerostep.org)

**1004 Type B Units** *(Nothing on Bathtub Height.)*

**Fair Housing Accessibility Guidelines** *(Nothing on Bathtub Height.)*

**2012 MI Building Code** *(Nothing on Bathtub Height.)*

**2015 MI Residential Code** *(Nothing on Bathrooms - Bathtub height.)*

**301.10 Toilet.** The toilet shall be positioned with a wall to the rear and a wall to one side. The centerline of the toilet shall be 18" on center from the side wall. If the toilet cannot be positioned against a wall to one side, the rear wall must have wall reinforcement with blocking for a future pull-down grab bar. Note: the side wall must be of adequate height, depth and strength for future grab bar installation.

**ANSI A117.1 – 2009**

**604 Water Closets and Toilet Compartments**

**604.1 General.** Accessible water closets and toilet compartments shall comply with Section 604. Compartments containing more than one plumbing fixture shall comply with Section 603. Wheelchair accessible compartments shall comply with Section 604.9. Ambulatory accessible compartments shall comply with Section 604.10.

**EXCEPTION:** Water closets and toilet compartments primarily for children's use shall be permitted to comply with Section 604.11 as applicable.

**604.2 Location.** The water closet shall be located with a wall or partition to the rear and to one side. The centerline of the water closet shall be 16 inches (405 mm) minimum to 18 inches (455 mm) maximum from the side wall or partition. Water closets located in ambulatory accessible compartments specified in Section 604.10 shall have the centerline of the water closet 17 inches (430 mm) minimum to 19 inches (485 mm) maximum from the side wall or partition.

**604.3 Clearance.**

**604.3.1 Clearance width.** Clearance around a water closet shall be 60 inches (1525 mm) minimum in width, measured perpendicular from the sidewall.

**604.3.2 Clearance Depth.** Clearance around the water closet shall be 56 inches (1420 mm) minimum in depth, measured perpendicular from the rear wall.

**604.3.3 Clearance Overlap.** The required clearance around the water closet shall be permitted to overlap the water closet, associated grab bars, paper dispensers, sanitary napkin receptacles, coat hooks, shelves, accessible routes, clear floor space at other fixtures and the turning space. No other fixtures or obstructions shall be within the required water closet clearance.

**ANSI A117.1 – 2009**

**1002 Accessible Units**

**1002.11 Toilet and Bathing Facilities.** At least one toilet and bathing facility shall comply with Section 1002.11.2. All other toilet and bathing facilities shall comply with Section 1002.11.1. (See [604.3.1](#).)

**ANSI A117.1 – 2009**

8/8/2016 10:04:11 AM

[www.zerostep.org](http://www.zerostep.org)

#### 1003 Type A Units

**1003.11.2.4 Water Closet.** Water closets shall comply with Section 1003.11.2.4.

**1003.11.2.4.1 Location.** The water closet shall be positioned with a wall to the rear and to one side. The centerline of the water closet shall be 16 inches (405 mm) minimum and 18 inches (455 mm) maximum from the sidewall.

#### ANSI A117.1 – 2009

##### 1004 Type B Units

**1004.11.3.1.2 Water Closet.** The water closet shall comply with Section 1004.11.3.1.2.

#### Fair Housing Accessibility Guidelines

See Section [100.205\(c\)\(3\)\(iv\)\(b\)\(iv\)](#).

#### 2012 MI Building Code

##### Section 1109 Other Features and Facilities

**1109.1 General.** Accessible building features and facilities shall be provided in accordance with Sections 1109.2 through 1109.14.

**EXCEPTION:** Accessible units, Type A and Type B dwelling and sleeping units shall comply with Chapter 10 or ICC A117.1.

#### 2015 MI Residential Code

##### Section P701 Fixtures, Faucets and Fixture Fittings

###### P2705 Installation

**P2705.1 General.** The installation of fixtures shall conform to the following:

5. Water closets, lavatories and bidets. A water closet, lavatory or bidet shall not be set closer than 15 inches (381 mm) from its center to any side wall, partition or vanity or closer than 30 inches (762 mm) center-to-center between adjacent fixtures. There shall be at least a 21-inch (533 mm) clearance in front of the water closet, lavatory or bidet to any wall, fixture or door.

**301.11 Shower Stall.** A minimum shower stall shall be 36" x 36". Shower stalls must comply with Shower Stall Approaches Table 301.10.

#### ANSI A117.1 – 2009

##### 608 Shower compartments

**608.1 General.** Accessible shower compartments shall comply with Section 608.

**608.2 Size, clearance and seat.** Shower compartments shall have sizes, clearances and seats complying with Section 608.2.

**608.2.1 Transfer-type Shower Compartments.** Transfer-type shower compartments shall comply with Section

8/8/2016 10:04:11 AM

[www.zerostep.org](http://www.zerostep.org)

608.2.1.

**608.2.1.1 Size.** Transfer-type shower compartments shall have a clear inside dimension of 36 inches (915 mm) in width and 36 inches (915 mm) in depth, measured at the center point of opposing sides. An entry 36 inches (915 mm) minimum in width shall be provided.

**608.2.1.2 Clearance.** A clearance of 48 inches (1220 mm) minimum in length measured perpendicular from the control wall, and 36 inches (915 mm) minimum in depth shall be provided adjacent to the open face of the compartment.

**608.2.1.3 Seat.** A folding or non-folding seat complying with Section 610 shall be provided on the wall opposite the control wall.

**Exception:** A seat is not required to be installed in a shower for a single occupant, accessed only through a private office and not for common use or public use, provided reinforcement has been installed in walls and located so as to permit the installation of a shower seat.

**608.2.2 Standard Roll-in-type Shower Compartments.** Standard roll-in-type shower compartments shall comply with Section 608.2.2.

**608.2.2.1 Size.** Standard roll-in-type shower compartments shall have a clear inside dimension of 60 inches (1525 mm) minimum in width and 30 inches (760 mm) minimum in depth, measured at the center point of opposing sides. An entry 60 inches (1525 mm) minimum in width shall be provided.

**608.2.2.2 Clearance.** A clearance of 60 inches (1525 mm) minimum in length adjacent to the 60-inch (1525 mm) width of the open face of the shower compartment, and 30 inches (760 mm) minimum in depth, shall be provided.

**EXCEPTION:** A lavatory complying with Section 606 shall be permitted at the end of the clearance opposite the seat.

**608.2.2.3 Seat.** A folding seat complying with Section 610 shall be provided on an end wall.

**EXCEPTIONS:**

1. A seat is not required to be installed in a shower for a single occupant accessed only through a private office and not for common use or public use, provided reinforcement has been installed in walls and located so as to permit the installation of a shower seat.
2. A fixed seat shall be permitted where the seat does not overlap the minimum clear inside dimension required by Section 608.2.2.1.

**608.2.3 Alternate Roll-in-type Shower Compartments.** Alternate roll-in-type shower compartments shall comply with Section 608.2.3.

**608.2.3.1 Size.** Alternate roll-in shower compartments shall have a clear inside dimension of 60 inches (1525 mm) minimum in width, and 36 inches (915 mm) in depth, measured at the center point of opposing sides. An entry 36 inches (915 mm) minimum in width shall be provided at one end of the 60-inch (1525 mm) width of the compartment. A seat wall, 24 inches (610 mm) minimum and 36 inches (915 mm) maximum in length, shall be provided on the entry side of the compartment.

**608.2.3.2 Seat.** A folding seat complying with Section 610 shall be provided on the seat wall opposite the back

wall.

**EXCEPTION:** A seat is not required to be installed in a shower for a single occupant, accessed only through a private office and not for common use or public use, provided reinforcement has been installed in walls and located so as to permit the installation of a shower seat.

(Nothing concerning a 36" x 36" size shower is also required in the same bathroom as a 30" x 60" minimum bathtub or bathing fixture.)

#### ANSI A117.1 – 2009

##### 1002 Accessible Units

**1002.11 Toilet and Bathing Facilities.** At least one toilet and bathing facility shall comply with Section 1002.11.2. All other toilet and bathing facilities shall comply with Section 1002.11.1. (See [608.2.1](#), [608.2.2](#), and [608.2.3](#).)

#### ANSI A117.1 – 2009

##### 1003 Type A Units

**1003.11.2.5.2 Shower.** Showers shall comply with Section 608. (See [608.2.1](#), [608.2.2](#), and [608.2.3](#).)

**EXCEPTION:** At standard roll-in shower compartments complying with Section 608.2.2, lavatories, counter tops and cabinetry shall be permitted at one end of the clearance, provided the following criteria are met:

- (a) The countertop and cabinetry can be removed;
- (b) The floor finish extends under the countertop and cabinetry; and
- (c) The walls behind and surrounding the countertop and cabinetry are finished.

#### ANSI A117.1 – 2009

##### 1004 Type B Units

**1004.11 Toilet and Bathing Facilities.** Toilet and bathing fixtures shall comply with Section 1004.11.

**EXCEPTION:** Fixtures on levels not required to be accessible.

**1004.11.3.1.3.3 Shower Compartment.** If a shower compartment is the only bathing facility, the shower compartment shall have dimensions of 36 inches (915 mm) minimum in width and 36 inches (915 mm) minimum in depth. A clearance of 48 inches (1220 mm) minimum in length, measured perpendicular from the shower head wall, and 30 inches (760 mm) minimum in depth, measured from the face of the shower compartment, shall be provided. Reinforcing for a shower seat is not required in shower compartments larger than 36 inches (915 mm) in width and 36 inches (915 mm) in depth.

#### Fair Housing Accessibility Guidelines

See Section [100.205\(c\)\(3\)\(iv\)\(a\)\(iv\)\(iii\)](#).

**2012 MI Building Code** (*Nothing on Bathrooms – Shower Stall.*)

**2015 MI Residential Code**

## Section P2708 Showers

**P2708.1 General.** Shower compartments shall have not less than 900 square inches (0.6 m<sup>2</sup>) of interior cross-sectional area. Shower compartments shall not be less than 30 inches (762 mm) in minimum dimension measured from the finished interior dimension of the shower compartment, exclusive of fixture valves, shower heads, soap dishes, and safety grab bars or rails. The minimum required area and dimension shall be measured from the finished interior dimension at a height equal to the top of the threshold and at a point tangent to its centerline and shall be continues to a height not less than 70 inches (1778 mm) above the shower drain outlet. Hinged shower doors shall open outward. The wall area above built-in tubs having installed shower heads and in shower compartments shall be constructed in accordance with Section R702.4. Such walls shall for a water tight joint with each other and with either the tub, receptor or shower floor.

### **EXCEPTIONS:**

1. Fold-down seats shall be permitted in the shower, provided the required 900 square-inch (0.6 m<sup>2</sup>) dimension is maintained when the seat is in the fold-up position.
2. Shower compartments having not less than 25 Inches (635 mm) in minimum dimension measured from the finished interior dimension of the compartment provided that he shower compartment has a cross-sectional area of not less than 1,300 square inches (0.838 m<sup>2</sup>).

**P2708.1.1 Access.** The shower compartment access and egress opening shall have a clear and unobstructed finished width of not less than 22 inches (559 mm).

**301.12 Sink Cabinet.** A minimum of a 36" wide cabinet shall be permitted under the bathroom sink provided the counter top shall be self-supportive and the base cabinet under the sink be in-fill. A cabinet without a center stile is recommended.

## ANSI A117.1 – 2009

### 1002 Accessible Units

#### 1002.11 Toilet and Bathing Facilities.

**1002.11.2.1 Vanity Counter Top Space.** If vanity counter top space is provided in dwelling or sleeping units not required to be Accessible units within the same facility, equivalent vanity counter top space, in terms of size and proximity to the lavatory, shall also be provided in Accessible units.  
(Nothing on Bathrooms – Sink Cabinet.)

## ANSI A117.1 – 2009

### 1003 Type A Units

**1003.11.2.2 Lavatory.** Lavatories shall comply with Section 606.

**EXCEPTION:** Cabinetry shall be permitted under the lavatory, provided the following criteria are met:

- (a) The cabinetry can be removed without removal or replacement of the lavatory;
- (b) The floor finish extends under the cabinetry; and
- (c) The walls behind and surrounding the cabinetry are finished.

(Nothing on Bathrooms - Sink Cabinet.)

## ANSI A 117.1 – 2003

8/8/2016 10:04:11 AM

[www.zerostep.org](http://www.zerostep.org)

## 1004 Type B Units

**1004.11.3.1.1 Lavatory.** A clear floor space complying with Section 305.3, positioned for a parallel approach, shall be provided at a lavatory. The clear floor space shall be centered on the lavatory.

**EXCEPTION:** A lavatory complying with Section 606 shall be permitted. Cabinetry shall be permitted under the lavatory provided the following criteria are met:

- (a) The cabinetry can be removed without removal or replacement of the lavatory; and
  - (b) The floor finish extends under the cabinetry; and
  - (c) The walls behind and surrounding the cabinetry are finished.
- (Nothing on Bathrooms – Sink Cabinet width.)

## Fair Housing Accessibility Guidelines

**Section 100.205(c)(3)(iv)(a) – Note:** Cabinets under lavatories are acceptable provided the bathroom has space to allow a parallel approach by a person in a wheelchair; if parallel approach is not possible within the space, any cabinets provided would have to be removable to afford the necessary knee clearance for forward approach.

## 2012 MI Building Code

### Section 1109 Other Features and Facilities.

#### 1109.2 Toilet and Bathing Facilities.

**1109.2.3 Lavatories.** Where lavatories are provided, at least 5 percent, but not less than one, shall be accessible. Where the total lavatories provided in a toilet room or bathing facility is six or more, at least one lavatory with enhanced reach ranges shall be provided.

**1109.3 Sinks.** Where sinks are provided at least 5 percent but not less than one provided in accessible spaces shall be accessible.

**EXCEPTIONS:** Mop and service sinks are not required to be accessible.

## 2015 MI Residential Code

### Section P701 Fixtures, Faucets and Fixture Fittings

#### P2705 Installation

**P2705.1 General.** The installation of fixtures shall conform to the following:

- 5. Water closets, lavatories and bidets. A water closet, lavatory or bidet shall not be set closer than 15 inches (381 mm) from its center to any side wall, partition or vanity or closer than 30 inches (762 mm) center-to-center between adjacent fixtures. There shall be at least a 21-inch (533 mm) clearance in front of the water closet, lavatory or bidet to any wall, fixture or door.

**301.13 Exposed Pipes.** Where knee space is provided under sinks, exposed pipes and surfaces shall be insulated or configured to protect against contact. There shall be no sharp or abrasive surfaces under sinks.

ANSI A117.1 – 2009  
606 Lavatories and Sinks



**606.6 Exposed Pipes and Surfaces.** Water supply and drainpipes under lavatories and sinks shall be insulated or otherwise configured to protect against contact. There shall be no sharp or abrasive surfaces under lavatories and sinks.

**ANSI A117.1 – 2009**

**1002 Accessible Units**

**1002.11 Toilet and Bathing Facilities.** At least one toilet and bathing facility shall comply with Section 1002.11.2. All other toilet and bathing facilities shall comply with Section 1002.11.1.

**ANSI A117.1 – 2009**

**1003 Type A Units** *(Nothing on Bathrooms – Exposed Pipes.)*

**ANSI A117.1 – 2009**

**1004 Type B Units** *(Nothing on Bathrooms – Exposed Pipes.)*

**Fair Housing Accessibility Guidelines** *(Nothing on Bathrooms – Exposed Pipes.)*

**2012 MI Building Code** *(Nothing on Bathrooms – Exposed Pipes.)*

**2015 MI Residential Code** *(Nothing on Bathrooms - Exposed pipes.)*

**These requirements are derived from the most recent edition of The ANSI Reference Codes, The Fair Housing Guidelines, The Michigan Building Codes and The Michigan Residential Codes. As these codes are updated, so too will the ZeroStep™ Guidelines.**

**The next edition of the ANSI Reference Codes is planned to increase the clear turning spaces from 60-inches in diameter to 67-inches in diameter. When the new editions are released, the ZeroStep™ Guidelines will be revised. Disability Advocates of Kent County recommends that these changes be considered in current construction design.**



## Chapter 4. Bedrooms

The contents of this section define what a ZeroStep™ bedroom is. Following each ZeroStep™ guidelines section are provided references to the most recent edition of The ANSI Reference Codes, The Fair Housing Guidelines, The Michigan Building Codes, and The Michigan Residential Codes, from which the measures and dimensions requirements were derived and expanded upon.

### 401 Bedrooms

**401.1 Location.** There shall be at least one bedroom on an accessible route, on the main floor, near an accessible bathroom.

**ANSI A117.1 – 2009**  
**1002 Accessible Units**

**1002.3 Accessible Route.** Accessible routes within Accessible units shall comply with Section 1002.3.

**ANSI A117.1 – 2009**  
**1003 Type A Units**

**1003.3 Accessible Route.** Accessible routes within Accessible units shall comply with Section 1003.3.

**ANSI A117.117.1 – 2003**  
**1004 Type B Units**

**1004.2 Primary Entrance.** The accessible primary entrance shall be on an accessible route from public and common areas. The primary entrance shall not be to a bedroom unless it is the only entrance.

**1004.3 Accessible Route.** Accessible routes within Accessible Type B units shall comply with Section 1004.3.

**1004.3.1 Location.** At least one accessible route shall connect all spaces and elements that are a part of the unit. Accessible routes shall coincide with or be located in the same area as a general circulation path.

**EXCEPTIONS:**

1. An accessible route is not required to unfinished attics and unfinished basements that are part of the unit.
2. One of the following is not required to be on an accessible route:
  - 2.1 A raised floor area in a portion of a living, dining, or sleeping room; or
  - 2.2 A sunken floor area in a portion of a living, dining, or sleeping room; or

2.3 A mezzanine that does not have plumbing fixtures or an enclosed habitable space.

#### Fair Housing Accessibility Guidelines

See Section [100.205\(c\)\(2\)\(1\)](#), Section [100.205\(c\)\(2\)\(2\)](#), Section [100.205\(c\)\(3\)\(i\)\(1\)](#), Section [100.205\(c\)\(3\)\(i\)\(2\)](#), and Section [100.205\(c\)\(3\)\(i\)\(4\)](#).

#### 2012 MI Building Code

##### Section 1104 Accessible Route

**1104.2 Within a site.** At least one accessible route shall connect accessible buildings, accessible facilities, accessible elements and accessible spaces that are on the same site.

**EXCEPTION:** An accessible route is not required between accessible buildings, accessible facilities, accessible elements and accessible spaces that have, as the only means of access between them, a vehicular way not providing for providing for pedestrian access.

##### Section 1107 Dwelling Units and Sleeping Units

**1107.1 General.** In addition to the other requirements of this chapter, occupancies having dwelling units or sleeping units shall be provided with accessible features in accordance with this section.

**1107.2 Design.** Dwelling units and sleeping units that are required to be Accessible units, Type A units and Type B units shall comply with the applicable portions of Chapter 10 of ICC A117.1. Units required to be Type A units are permitted to be designed and constructed as Accessible units. Units required to be Type B units are permitted to be designed and constructed as Accessible units or as Type A units.

**1107.3 Accessible space.** Rooms and spaces available to the general public or available for use by residents and servicing Accessible units, Type A or Type B units shall be accessible. Accessible spaces shall include toilet and bathing rooms, kitchen, living and dining areas and any exterior spaces, including patios, terraces and balconies.

**1107.4 Accessible route.** At least one accessible route shall connect accessible building for facility entrances with the primary entrance of each Accessible unit, Type A unit and Type B unit within the building or facility and with those exterior and interior spaces and facilities that serve the units.

**EXCEPTIONS:**

1. If due to circumstances outside the control of the owner, either the slope of the finished ground level between accessible facilities and buildings exceeds one unit vertical in 12 units horizontal (1:12), or where physical barriers or legal restrictions prevent the installation of an accessible route, a vehicular route with parking that complies with Section 1106 at each public or common use facility or building is permitted in place of the accessible route.
2. Exterior decks, patios or balconies that are part of Type B units and have impervious surfaces, and that are not more than 4 inches (102 mm) below the finished floor level of the adjacent interior space of the unit.

#### 2015 MI Residential Code *(Nothing on Bedrooms - Location.)*

**401.2 Turning Space.** There shall be a clear 5' diameter turning space close to the bedroom entrance door, unobstructed by furniture or furnishings.

8/8/2016 10:04:11 AM

[www.zerostep.org](http://www.zerostep.org)

**ANSI A117.1 – 2009**

**1002 Accessible Units**

**1002.3 Accessible Route.** Accessible routes within Accessible units shall comply with Section 1002.3.

**1002.3.2 Turning Space.** All rooms served by an accessible route shall provide a turning space complying with Section 304 Turning Space. (See below 304.3.1 and 304.3.2.)

**EXCEPTIONS:**

1. A turning space is not required in toilet rooms and bathrooms that are not required to comply with Section 1002.11.2.
2. A turning space is not required within closets or pantries that are 48 inches (1220 mm) maximum in depth.

**304.3.1 Circular Space.** The turning space shall be a circular space with a 60-inch (1525 mm) minimum diameter. The turning space shall be permitted to include knee and toe clearance complying with Section 306.

**304.3.2 T-Shaped Space.** The turning space shall be a T-shaped space within a 60-inch (1525 mm) minimum square, with arms and base 36 inches (915 mm) minimum in width. Each arm of the T shall be clear of obstructions 12 inches (305 mm) minimum in each direction, and the base shall be clear of obstructions 24 inches (610 mm) minimum. The turning space shall be permitted to include knee and toe clearance complying with Section 306 only at the end of either the base or one arm.

**ANSI A117.1 – 2009**

**1003 Type A Units**

**1003.3 Accessible Route.** Accessible routes within Accessible units shall comply with Section 1003.3.

**1003.3.2 Turning Space.** All rooms served by an accessible route shall provide a turning space complying with Section 304 Turning Space. (See above reference [304.3.1](#) and [304.3.2](#).)

**EXCEPTIONS:**

1. A turning space is not required in toilet rooms and bathrooms that are not required to comply with Section 1003.11.2.
2. A turning space is not required within closets or pantries that are 48 inches (1220 mm) maximum in depth.

**ANSI A117.1 – 2009**

**1004 Type B Units**

**1004.3 Accessible Route.** Accessible routes within Type B units shall comply with Section [1004.3](#).  
(Nothing on Bedrooms – Turning Space.)

**2012 MI Building Code** (Nothing on Bedrooms - Turning Space.)

**2015 MI Residential Code** (Nothing on Bedrooms - Turning Space.)

**401.3 Doors.** Doors shall comply with Section 201.

**ANSI A117.1 – 2009**

**1002 Accessible Units**

**1002.5 Doors and Doorways.** The primary entrance door to the unit, and all other doorways intended for user passage, shall comply with Section 404.

**EXCEPTIONS:**

1. Existing doors to hospital patient sleeping rooms shall be exempt from the requirement for space at the latch side provided the door is 44 inches (1120 mm) minimum in width.
2. In toilet rooms and bathrooms not required to comply with Section 1002.11.2, maneuvering clearances required by [Section 404.2.3](#) are not required on the toilet room or bathroom side of the door.
3. A turning space between doors in a series as required by [Section 404.2.5](#) is not required.
4. Storm and screen doors are not required to comply with [Section 404.2.5](#).
5. Communicating doors between individual sleeping units are not required to comply with [Section 404.2.5](#).
6. At other than the primary entrance door, where exterior space dimensions of balconies are less than the required maneuvering clearance, door maneuvering clearance is not required on the exterior side of the door.

**ANSI A117.1 – 2009**

**1003 Type A Units**

**1003.5 Doors and Doorways.** The primary entrance door to the unit, and all other doorways intended for user passage, shall comply with Section 404. .

**EXCEPTIONS:**

1. Thresholds at exterior sliding doors shall be permitted to be  $\frac{3}{4}$  inch (19 mm) maximum in height, provided they are beveled with a slope not greater than 1:2.
2. In toilet rooms and bathrooms not required to comply with Section 1003.11.2, maneuvering clearances required by [Section 404.2.3](#) are not required on the toilet room or bathroom side of the door.
3. A turning space between doors in a series as required by [Section 404.2.5](#) is not required.
4. Storm and screen doors are not required to comply with [Section 404.2.5](#).
5. Communicating doors between individual sleeping units are not required to comply with [Section 404.2.5](#).
6. At other than the primary entrance door, where exterior space dimensions of balconies are less than the required maneuvering clearance, door maneuvering clearance is not required on the exterior side of the door.

**ANSI A117.1 – 2009**

**1004 Type B Units**

**1004.5 Doors and Doorways.** Doors and doorways shall comply with Section 1004.5.

**1004.5.1 Primary Entrance Door.** The primary entrance door to the unit shall comply with Section 404.

**EXCEPTION:** Storm and screen doors serving individual dwelling or sleeping units are not required to comply with Section 404.2.5.

**Fair Housing Accessibility Guidelines**

See Section [100.205\(c\)\(2\)\(2\)](#)

**2012 MI Building Code**

**Section 1008 Doors, Gates and Turnstiles**

See [1008.1](#) and [1008.1.1](#).

**2015 MI Residential Code**

**Section 311 Means of Egress**

**R311.2.1 Interior Doors.** Interior doors shall not be less than 24 inches (609 mm) in width and 6 feet, 6 Inches (1980 mm) in height.

**EXCEPTION:** Doors to areas less than 10 square feet of floor area.

**These requirements are derived from the most recent edition of The ANSI Reference Codes, The Fair Housing Guidelines, The Michigan Building Codes and The Michigan Residential Codes. As these codes are updated, so too will the ZeroStep™ Guidelines.**

**The next edition of the ANSI Reference Codes is planned to increase the clear turning spaces from 60-inches in diameter to 67-inches in diameter. When the new editions are released, the ZeroStep™ Guidelines will be revised. Disability Advocates of Kent County recommends that these changes be considered in current construction design.**



## Chapter 5. Closets

The contents of this section define what a ZeroStep™ closet is. Following each ZeroStep™ guidelines section are provided references to the most recent edition of The ANSI Reference Codes, The Fair Housing Guidelines, The Michigan Building Codes, and The Michigan Residential Codes, from which the measures and dimensions requirements were derived and expanded upon.

### 501 Closets

**501.1 Location.** One accessible closet is in an accessible bedroom.

**ANSI A117.1 – 2009**  
**1002 Accessible Units**

**1002.3 Accessible Route.** Accessible routes within Accessible units shall comply with Section 1002.3.

**ANSI A117.1 – 2009**  
**1003 Type A Units**

**1003.3 Accessible Route.** Accessible routes within Type A units shall comply with Section 1003.3.

**ANSI A117.1 – 2009**  
**1004 Type B Units**

**1004.3 Accessible Route.** Accessible routes within Type B units shall comply with Section 1004.3. (See [1004.3.1](#) and [1004.3.2](#).)

**Fair Housing Accessibility Guidelines** (*Nothing on Closets – Location.*)

**2012 MI Building Code** (*Nothing on Closets – Location.*)

**2015 MI Residential Code** (*Nothing on Closets – Location.*)

**501.2 Clear Floor Space.** A 48" x 48" minimum clear floor space is in front of a wall closet.

**ANSI A117.1 – 2009**  
**1002 Accessible Units** (*Nothing on Closets – Clear Floor Space, yet see [305.3](#) and [305.5](#).)*)

**ANSI A117.1 – 2009**

**1003 Type A Units** *(Nothing on Closets – Clear Floor Space, yet see [305.3](#) and [305.5](#).)*

**ANSI A117.1 – 2009**

**1004 Type B Units** *(Nothing on Closets – Clear Floor Space, yet see [305.3](#) and [305.5](#).)*

**Fair Housing Accessibility Guidelines** *(Nothing on Closets – Clear Floor Space.)*

**2012 MI Building Code** *(Nothing on Closets – Clear Floor Space.)*

**2015 MI Residential Code** *(Nothing on Closets – Clear Floor Space.)*

**501.3 Doors.** Shall comply with [Section 201, Doors and Doorways](#). Closet doors may overlap the 48" x 48" clear floor space.

**ANSI A117.1 – 2009**

**1002 Accessible Units** *(Nothing on Closet – Doors if the doors are not to a walk-in or roll-in closet.)*

**ANSI A117.1 – 2009**

**1003 Type A Units** *(Nothing on Closet – Doors if the doors are not to a walk-in or roll-in closet.)*

**ANSI A117.1 – 2009**

**1004 Type B Units** *(Nothing on Closet – Doors if the doors are not to a walk-in or roll-in closet.)*

**Fair Housing Accessibility Guidelines** *(Nothing on Closet – Doors if the doors are not to a walk-in or roll-in closet.)*

**2012 MI Building Code** *(Nothing on Closet – Doors if the doors are not to a walk-in or roll-in closet.)*

**2015 MI Residential Code** *(Nothing on Closet – Doors if the doors are not to a walk-in or roll-in closet.)*

**501.4 Lighting.** Lighting shall be installed in accessible walk-in closets in accordance with [Michigan Residential Code E3903.1](#).

**ANSI A117.1 – 2009**

**1002 Accessible Units** *(Nothing on Closets – Lighting.)*

**ANSI A117.1 – 2009**

**1003 Type A Units** *(Nothing on Closets – Lighting.)*

**ANSI A117.1 – 2009**

**1004 Type B Units** *(Nothing on Closets – Lighting.)*

**Fair Housing Accessibility Guidelines** *(Nothing on Closets – Lighting.)*

**2012 MI Building Code** *(Nothing on Closets – Lighting.)*

**2015 MI Residential Code**



## Section E3903 Lighting outlets

**E3903.1 General.** Lighting outlets shall be provided in accordance with Section E3903.2 through E3903.4.

**E3903.2 Habitable rooms.** At least one wall switch-controlled lighting outlet shall be installed in every habitable room and bathroom.

### EXCEPTIONS:

1. In other than kitchens and bathrooms, one or more receptacles controlled by a wall switch shall be considered equivalent to the required lighting outlet.
2. Lighting outlets shall be permitted to be controlled by occupancy sensors that are in addition to wall switches, or that are located at a customary wall switch location and equipped with a manual override that will allow the sensor to function as a wall switch.

**E3903.3 Additional locations.** At least one wall-switch-controlled lighting outlet shall be installed in hallways, stairways, attached garages, and detached garages with electric power. At least one wall-switch-controlled lighting outlet shall be installed to provide illumination on the exterior side of each outdoor egress door having grade level access, including outdoor egress doors for attached garages and detached garages with electric power. A vehicle door in a garage shall not be considered as an outdoor egress door. Where one or more lighting outlets are installed for interior stairways, there shall be a wall switch at each floor level and landing level that includes an entryway to control the lighting outlets where the stairway between floor levels has six or more risers.

**E3903.4 Storage or equipment spaces.** In attics, underfloor spaces, utility room and basements, at least one lighting outlet shall be installed where these spaces are used for storage or contain equipment requiring servicing. Such lighting outlet shall be controlled by a wall switch or shall have an integral switch. At least one point of control shall be at the usual point of entry to these spaces. The lighting outlet shall be provided at or near the equipment requiring servicing.

**These requirements are derived from the most recent edition of The ANSI Reference Codes, The Fair Housing Guidelines, The Michigan Building Codes and The Michigan Residential Codes. As these codes are updated, so too will the ZeroStep™ Guidelines.**

**The next edition of the ANSI Reference Codes is planned to increase the clear floor spaces from 48-inches by 48-inches to 52-inches by 52-inches. When the new editions are released, the ZeroStep™ Guidelines will be revised. Disability Advocates of Kent County recommends that these changes be considered in current construction design.**



## Chapter 6. Kitchens

The contents of this section define what a ZeroStep™ kitchen is. Following each ZeroStep™ guidelines section are provided references to the most recent edition of The ANSI Reference Codes, The Fair Housing Guidelines, The Michigan Building Codes, and The Michigan Residential Codes, from which the measures and dimensions requirements were derived and expanded upon.

### 601 Kitchens

**601.1 Location.** There shall be at least one accessible kitchen on the main floor on an accessible route.

ANSI A117.1 – 2009

1002 Accessible Units

**1002.3 Accessible Route.** Accessible routes within Accessible units shall comply with Section 1002.3

ANSI A117.1 – 2009

1003 Type A Units

**1003.3 Accessible Route.** Accessible routes within Type A units shall comply with Section 1003.3.

ANSI A117.1 – 2009

1004 Type B Units

**1004.3 Accessible Route.** Accessible routes within Type B units shall comply with Section 1004.3. (See [1004.3.1](#) and [1004.3.2](#).)

Fair Housing Accessibility Guidelines

See Section [100.205\(c\)\(3\)\(iv\)](#).

2009 MI Building Code

Section 1107 Dwelling Units and Sleeping Units

See [1107.3](#).

2009 MI Residential Code (*Nothing on Kitchens – Location.*)

2015 MI Residential Code (Nothing on Kitchens - Location.)

**601.2 Doors.** Doors and doorways shall comply with Section 201.

**ANSI A117.1 – 2009**

**1002 Accessible Units**

**1002.5 Doors and Doorways.** The primary entrance door to the unit, and all other doorways intended for user passage, shall comply with Section 404. (See 404.1, 404.2, 404.2.1, 404.2.2, 404.2.3.1, 404.2.3.2, 404.2.3.3, 404.2.3.4, 404.2.3.5, 404.2.4, and 404.3.3.)

**ANSI A117.1 – 2009**

**1003 Type A Units**

**1003.5 Doors and Doorways.** The primary entrance door to the unit, and all other doorways intended for user passage, shall comply with Section 404. (See 404.1, 404.2, 404.2.1, 404.2.2, 404.2.3.1, 404.2.3.2, 404.2.3.3, 404.2.3.4, 404.2.3.5, 404.2.4, and 404.3.3.)

**EXCEPTIONS:**

1. Thresholds at exterior sliding doors shall be permitted to be ¼ inch (19 mm) maximum in height, provided they are beveled with a slope not greater than 1:2.
2. In toilet rooms and bathrooms not required to comply with Section 1003.11, maneuvering clearances required by Section 404.2.3 are not required on the toilet room or bathroom side of the door.
3. A turning space between doors in a series as required by Section 404.2.5 is not required.
4. Storm and screen doors are not required to comply with Section 404.2.5.
5. Communicating doors between individual sleeping units are not required to comply with Section 404.2.5.
6. At other than the primary entrance door, where exterior space dimensions of balconies are less than the required maneuvering clearance, door maneuvering clearance is not required on the exterior side of the door.

**ANSI A117.1 – 2009**

**1004 Type B Units**

**1004.5 Doors and Doorways.** Doors and doorways shall comply with Section 1004.5. (See 1004.5.1, 1004.5.2, 1004.5.2.1, 1004.5.2.2, 1004.5.2.3, and 1004.5.4.)

**Fair Housing Accessibility Guidelines**

See Section 100.205(c)(2)(2)

**2012 MI Building Code**

**Section 1008 Doors, Gates and Turnstiles**

See 1008.1 and 1008.1.1.

**2015 MI Residential Code**

**Section 311 Means of Egress**

**R311.2.1 Interior Doors.** Interior doors shall not be less than 24 inches (609 mm) in width and 6 feet, 6 Inches (1980 mm) in height.

8/8/2016 10:04:11 AM

www.zerostep.org

**EXCEPTION:** Doors to areas less than 10 square feet of floor area.

**601.3 Turning Space.** There shall be a 5' diameter turning space within the kitchen area. The turning space may overlap approaches at fixtures.

**EXCEPTION:** A galley kitchen may have a minimum 48" clearance between all opposing base cabinets, countertops, appliances or walls, with a 5' diameter turning space at either end.

An island may have a minimum 48" clearance between all opposing base cabinets, countertops, appliances or walls measured beneath the counter, with a 5' diameter turning space located in the kitchen.

**ANSI A117.1 – 2009**

**1002 Accessible Units**

**1002.3.2 Turning Space.** All rooms served by an accessible route shall provide a turning space complying with Section 304 Turning Space. (See [304.3.1](#) and [304.3.2](#).)

**ANSI A117.1 – 2009**

**1003 Type A Units**

**1003.3.2 Turning Space.** All rooms served by an accessible route shall provide a turning space complying with Section 304 Turning Space. (See [304.3.1](#) and [304.3.2](#).)

**ANSI A 117.1 – 2003**

**1004 Type B Units** (*Nothing on Kitchens - Turning Space.*)

**Fair Housing Accessibility Guidelines**

**Section 100.205(c)(7)(1).** Usable kitchens would meet section 100.205 (c) (3) (iv) if:

**Section 100.205(c)(7)(1)(c).** In U-shaped kitchens with sink or range or cooktop at the base of the "U", a 60 – inch turning radius is provided to allow parallel approach, or base cabinets are removable at that location to allow knee space for a forward approach.

**2012 MI Building Code**

**Section 1107 Dwelling Units and Sleeping Units**

See [1007.2](#).

**2015 MI Residential Code** (*Nothing on Kitchens - Turning Spaces.*)

**601.4 Clear Floor Space.** A 48" x 48" minimum clear floor space shall be provided at ranges, cooktops, ovens, wall-mount ovens, dishwashers, kitchen sinks, microwave ovens, pantry, refrigerators, and trash compactors.

**ANSI A117.1 – 2009**

8/8/2016 10:04:11 AM

[www.zerostep.org](http://www.zerostep.org)

## 804 Kitchens and Kitchenettes

**804.1 General.** Accessible kitchens and kitchenettes shall comply with Section 804.

**804.2 Clearance.** Where a pass-through kitchen is provided, clearances shall comply with Section 804.2.1. Where a U-shaped kitchen is provided, clearances shall comply with Section 804.2.2.

**EXCEPTION:** Spaces that do not provide a cooktop or conventional range shall not be required to comply with Section 804.2 provided there is a 40-inch (1015 mm) minimum clearance between all opposing base cabinets, counter tops, appliances, or wall within work areas.

**804.2.1 Pass-through Kitchens.** In pass-through kitchens where counters, appliances or cabinets are on two opposing sides, or where counters, appliances or cabinets are opposite a parallel wall, clearance between all opposing base cabinets, counter tops, appliances, or walls within kitchen work areas shall be 40 inches (1015 mm) minimum. Pass-through kitchens shall have two entries.

**804.2.2 U-Shaped Areas.** In kitchens enclosed on three contiguous sides, clearance between all opposing base cabinets, countertops, appliances, or walls within kitchen work areas shall be 60 inches (1525 mm) minimum.

**804.5 Appliances.** Where provided, kitchen appliances shall comply with Section 804.5.

**804.5.1 Clear Floor Space.** A clear floor space complying with Section 305 shall be provided at each kitchen appliance.

**804.5.3 Dishwasher.** A clear floor space, positioned adjacent to the dishwasher door, shall be provided. The dishwasher door in the open position shall not obstruct the clear floor space for the dishwasher or an adjacent sink.

**804.5.4 Cooktop. Cooktops shall comply with Section 804.5.4.**

**804.5.4.1 Approach.** A clear floor space, positioned for a parallel or forward approach to the cooktop, shall be provided.

**804.5.4.2 Forward approach.** Where the clear floor space is positioned for a forward approach, knee and toe clearance complying with Section 306 shall be provided. The underside of the cooktop shall be insulated or otherwise configured to prevent burns, abrasions, or electrical shock.

**804.5.4.3 Parallel approach.** Where the clear floor space is positioned for a parallel approach, the clear floor space shall be centered on the appliance.

**804.5.5 Oven.** Ovens shall comply with Section 804.5.5.

**804.5.5.1 Clear floor space.** A clear floor space shall be provided. The oven door in the open position shall not obstruct the clear floor space for the oven.

**804.5.6 Refrigerator/Freezer.** Combination refrigerators and freezers shall have at least 50 percent of the freezer compartment shelves, including the bottom of the freezer, 54 inches (1370 mm) maximum above the floor when the shelves are installed at the maximum heights possible in the compartment. A clear floor space, positioned for a parallel approach to the space dedicated to a refrigerator/freezer, shall be provided. The centerline of the clear floor space shall be offset 24 inches (610 mm) maximum from the centerline of the appliance.

## 305 Clear Floor Space

**305.1 General.** A clear floor space shall comply with Section 305.

8/8/2016 10:04:11 AM

[www.zerostep.org](http://www.zerostep.org)

Appendix B: Code Comparisons 194

**305.2 Floor Surfaces.** Floor surfaces of a clear floor space shall comply with Section 302. Changes in level are not permitted within the clear floor space.

**EXCEPTION:** Slopes not steeper than 1:48 and shall be permitted.

**305.3 Size.** The clear floor space shall be 48 inches (1220 mm) minimum in length and 30 inches (760 mm) minimum in width.

**305.4 Knee and Toe Clearance.** Unless otherwise specified, clear floor space shall be permitted to include knee and toe clearance complying with Section 306.

**305.5 Position.** Unless otherwise specified, the clear floor space shall be positioned for either forward or parallel approach to an element.

**305.6 Approach.** One full, unobstructed side of the clear floor space shall adjoin or overlap an accessible route or adjoin another clear floor space.

**305.7 Alcoves.** If a clear floor space is in an alcove or otherwise confirmed on all or part of three sides, additional maneuvering clearances complying with Sections 305.7.1 and 305.7.2 shall be provided, as applicable.

**305.7.1 Parallel Approach.** Where the clear floor space is positioned for a parallel approach, the alcove shall be 60 inches (1525 mm) minimum in width where the depth exceeds 15 inches (380 mm).

**305.7.2 Forward Approach.** Where the clear floor space is positioned for a forward approach, the alcove shall be 36 inches (915 mm) minimum in width where the depth exceeds 24 inches (610 mm).

### **306 Knee and Toe Clearance**

**306.1 General.** Where space beneath an element is included as part of clear floor space at an element, clearance at an element, or a turning space, the space shall comply with Section 306. Additional space shall not be prohibited beneath an element, but shall not be considered as part of the clear floor space or turning space.

#### **306.2 Toe Clearance.**

**306.2.1 General.** Space beneath an element between the floor and 9 inches (230 mm) above the floor shall be considered toe clearance and shall comply with Section 306.

**306.2.2 Maximum Depth.** Toe clearance shall be permitted to extend 25 inches (635 mm) maximum under an element.

**306.2.3 Minimum Depth.** Where toe clearance is required at an element as part of a clear floor space, the toe clearance shall extend 17 inches (430 mm) minimum beneath the element.

**306.2.4 Additional Clearance.** Space extending greater than 6 inches (150 mm) beyond the available knee clearance at 9 inches (230 mm) above the floor shall not be considered toe clearance.

**306.2.5 Width.** Toe clearance shall be 30 inches (760 mm) minimum in width.

#### **306.3 Knee Clearance.**

**306.3.1 General.** Space beneath an element between 9 inches (230 mm) and 27 inches (685 mm) above the floor

shall be considered knee clearance and shall comply with Section 306.3.

**306.3.2 Maximum Depth.** Knee clearance shall be permitted to extend 25 inches (635 mm) maximum under an element at 9 inches (230 mm) above the floor.

**306.3.3 Minimum Depth.** Where knee clearance is required beneath an element as part of a clear floor space complying with Section 305, the knee clearance shall be 11 inches (280 mm) minimum in depth at 9 inches (230 mm) above the floor, and 8 inches (205 mm) minimum in depth at 27 inches (685 mm) above the floor.

**306.3.4 Clearance Reduction.** Between 9 inches (230 mm) and 27 inches (685 mm) above the floor, the knee clearance shall be permitted to be reduced at a rate of 1 inch (25 mm) in depth for each 6 inches (150 mm) in height.

**306.3.5 Width.** Knee clearance shall be 30 inches (760 mm) minimum in width.

### 309 Operable Parts

**309.2. Clear Floor Space.** A clear floor space complying with Section 305 shall be provided.

### 902 Dining Surfaces and Work Surfaces

**902.2 Clear Floor Space.** Clear floor space complying with Section ~~305~~ positioned for a forward approach, shall be provided.

### ANSI A117.1 – 2009

#### 1002 Accessible Units

**1002.12 Kitchens and kitchenettes.** Kitchens and kitchenettes shall comply with Section 804. At least one work surface, 30 inches (760 mm) minimum in length, shall comply with Section ~~902~~.

**EXCEPTION:** Spaces that do not provide a cooktop or conventional range shall not be required to provide an accessible work surface.

### ANSI A117.1 – 2009

#### 1002 Accessible Units

**1002.12 Kitchens and kitchenettes.** Kitchens and kitchenettes shall comply with Section 1003.12.

### 1003 Type A Units

**1003.12 Kitchen and kitchenettes.** Kitchen and kitchenettes shall comply with Section 1003.12.

**1003.12.1 Clearance.** Clearance complying with Section 1003.12.1 shall be provided.

**1003.12.1.1 Minimum Clearance.** Clearance between all opposing base cabinets, counter tops, appliances, or walls within kitchen work areas shall be 40 inches (1015 mm) minimum.

**1003.12.1.2 U-Shaped Kitchens.** In kitchens with counters, appliances, or cabinets on three contiguous sides, clearance between all opposing base cabinets, countertops, appliances, or walls within kitchen work areas shall be 60 inches (1525 mm) minimum.

**1003.12.2 Clear Floor Space.** Clear floor spaces required by Sections 1003.12.3 through 1003.12.6 shall comply with Section ~~305~~.

**1003.12.3 Work Surface.** At least one section of counter shall provide a work surface 30 inches (760 mm) minimum in length complying with Section 1003.12.3.

**1003.12.3.1 Clear Floor Space.** A clear floor space, positioned for a forward approach to the work surface, shall be provided. Knee and toe clearance complying with Section [306](#) shall be provided. The clear floor space shall be centered on the work surface.

**EXCEPTION:** Cabinetry shall be permitted under the work surface, provided the following criteria are met:

- (a) The cabinetry can be removed without removal or replacement of the work surface,
- (b) The floor finish extends under the cabinetry, and
- (c) The walls behind and surrounding the cabinetry are finished.

**1003.12.4 Sink.** Sinks shall comply with Section 1003.12.4.

**1003.12.4.1 Clear Floor Space.** A clear floor space, positioned for a forward approach to the sink, shall be provided. Knee and toe clearance complying with Section [306](#) shall be provided.

**EXCEPTIONS:**

1. The requirement for knee and toe clearance shall not apply to more than one bowl of a multi-bowl sink.
2. Cabinetry shall be permitted to be added under the sink, provided:
  - (a) The cabinetry can be removed without removal or replacement of the sink,
  - (b) The floor finish extends under such cabinetry, and
  - (c) The walls behind and surrounding cabinetry are finished.

**1003.12.6 Appliances.** Where provided, kitchen appliances shall comply with Section 1003.12.6.

**1003.12.5.2 Clear Floor Space.** A clear floor space, positioned for a parallel or forward approach, shall be provided at each kitchen appliance.

**1003.12.5.3 Dishwasher.** A clear floor space, positioned adjacent to the dishwasher door, shall be provided. The dishwasher door in the open position shall not obstruct the clear floor space for the dishwasher or an adjacent sink.

**1003.12.5.4 Cooktop.** Cooktops shall comply with Section 1003.12.5.4.

**1003.12.5.4.1 Approach.** A clear floor space positioned for a parallel or forward approach to the cooktop shall be provided.

**1003.12.5.4.2 Forward approach.** Where the clear floor space is positioned for a forward approach, knee and toe clearance complying with [Section 306](#) shall be provided. The underside of the cooktop shall be insulated or otherwise configured to protect from burns, abrasions, or electrical shock.

**1003.12.5.4.3 Parallel approach.** Where the clear floor space is positioned for a parallel approach, the clear floor space shall be centered on the appliance.

**1003.12.5.4.4 Controls.** The location of controls shall not require reaching across burners.

**1003.12.5.5 Oven.** Ovens shall comply with Section 1003.12.5.5. Ovens shall have controls on front panels, on either side of the door.

**1003.12.5.5.1 Clear floor space.** A clear floor space shall be provided. The oven door in the open position shall not obstruct the clear floor space for the oven.

**1003.12.5.5.2 Side-Hinged Door Ovens.** Side-hinged door ovens shall have a countertop positioned adjacent to the latch side of the oven door.

**1003.12.5.5.3 Bottom-Hinged Door Ovens.** Bottom-hinged door ovens shall have a countertop positioned adjacent to one side of the door.

**1003.12.5.5.4 Controls.** The location of controls shall not require reaching across burners.



**1003.12.5.6 Refrigerator/Freezer.** Combination refrigerators and freezers shall have at least 50 percent of the freezer compartment shelves, including the bottom of the freezer 54 inches (1370 mm) maximum above the floor when the shelves are installed at the maximum heights possible in the compartment. A clear floor space, positioned for a parallel approach to the refrigerator/freezer, shall be provided. The centerline of the clear floor space shall be offset 24 inches (610 mm) maximum from the centerline of the appliance.

**ANSI A117.1 – 2009**

**1004 Type B Units**

**1004.12 Kitchens and kitchenettes.** Kitchens and kitchenettes shall comply with Section 1004.12.

**1004.12.1 Clearance.** Clearance complying with Section 1004.12.1 shall be provided;

**1004.12.1.1 Minimum Clearance.** Clearance between all opposing base cabinets, counter tops, appliances, or wall within kitchen work areas shall be 40 inches (1015 mm) minimum.

**1004.12.1.2 U-Shaped Kitchens.** In kitchens with counters, appliances, or cabinets on three contiguous sides, clearance between all opposing base cabinets, countertops, appliances, or walls within kitchen work areas shall be 60 inches (1525 mm) minimum.

**1004.12.2 Clear floor Space.** Clear floor space at appliances shall comply with Sections [1004.12.2](#) and [305.3](#).

**1004.12.2.1 Sink.** A clear floor space, positioned for a parallel approach to the sink, shall be provided. The clear floor space shall be centered on the sink bowl.

**EXCEPTION:** A sink with a forward approach complying with Section 1003.12.4.1.

**1004.12.2.2 Dishwasher.** A clear floor space, positioned for a parallel or forward approach to the dishwasher, shall be provided. The dishwasher door in the open position shall not obstruct the clear floor space for the dishwasher.

**1004.12.2.3 Cooktop.** Cooktops shall comply with Section 1004.12.2.3.

**1004.12.2.3.1 Approach.** A clear floor space, positioned for a parallel or forward approach to the cooktop, shall be provided.

**1004.12.2.3.2 Forward approach.** Where the clear floor space is positioned for a forward approach, knee and toe clearance complying with [Section 306](#) shall be provided. The underside of the cooktop shall be insulated or otherwise configured to prevent burns, abrasions, or electrical shock.

**1004.12.2.3.3 Parallel approach.** Where the clear floor space is positioned for a parallel approach, the clear floor space shall be centered on the appliance.

**1004.12.2.4 Oven.** A clear floor space, positioned for a parallel or forward approach adjacent to the oven shall be provided. The oven door in the open position shall not obstruct the clear floor space for the oven.

**1004.12.2.5 Refrigerator/Freezer.** A clear floor space, positioned for a parallel approach to the refrigerator/freezer, shall be provided. The centerline of the clear floor space shall be offset 24 inches (610 mm) maximum from the centerline of the appliance.

**1004.12.2.6 Trash Compactor.** A clear floor space, positioned for a parallel or forward approach to the trash compactor, shall be provided.

## Fair Housing Accessibility Guidelines

**Section 100.205(c)(7)(1).** Usable kitchens would meet section 100.205(c)(3)(iv) if:

**Section 100.205(c)(7)(1)(a).** A clear floor space at least 30 inches by 48 inches that allows a parallel approach by a person in a wheelchair is provided at the range or cooktop and sink, and either a parallel or forward approach is provided at oven, dish washer, refrigerator/freezer or trash compactor.

## 2012 MI Building Code

### Section 1107 Dwelling Units and Sleeping Units

See 1007.2.

**2015 MI Residential Code** (*Nothing on Kitchens - Clear Floor Spaces.*)

**601.4.1 Sink.** The centerline of the sink shall align with the centerline of the clear floor space.

## ANSI A117.1 – 2009

**1002 Accessible Units** (*Nothing on Kitchens – Sink, centerline.*)

## ANSI A117.1 – 2009

**1003 Type A Units**

**1003.12.4.1 Clear Floor Space.** A clear floor space, positioned for a forward approach to the sink, shall be provided. Knee and toe clearance complying with Section 306 shall be provided.

### **EXCEPTIONS:**

1. The requirement for knee and toe clearance shall not apply to more than one bowl of a multi-bowl sink.
2. Cabinetry shall be permitted to be added under the sink, provided the following criteria are met:
  - (a) The cabinetry can be removed without removal or replacement of the sink,
  - (b) The floor finish extends under the cabinetry, and
  - (c) The walls behind and surrounding the cabinetry are finished.

## ANSI A117.1 – 2009

**1004 Type B Units**

**1004.12.2 Clear Floor Space.** Clear floor space at appliances shall comply with Sections 1004.12.2 and 305.3.

**1004.12.2.1 Sink.** A clear floor space, positioned for a parallel approach to the sink, shall be provided. The clear floor space shall be centered on the sink bowl.

**EXCEPTION:** A skink with a forward approach complying with Section 1003.12.4.1.

**Fair Housing Accessibility Guidelines** (*Nothing on Kitchens – Sink, centerline.*)

**2012 MI Building Code** (*Nothing on Kitchens – Sink, centerline.*)

**2015 MI Residential Code**

## Section P701 Fixtures, Faucets and Fixture Fittings

### P2705 Installation

**P2705.1 General.** The installation of fixtures shall conform to the following:

5. Water closets, lavatories and bidets. A water closet, lavatory or bidet shall not be set closer than 15 inches (381 mm) from its center to any side wall, partition or vanity or closer than 30 inches (762 mm) center-to-center between adjacent fixtures. There shall be at least a 21-inch (533 mm) clearance in front of the water closet, lavatory or bidet to any wall, fixture or door

**601.5 Sink Cabinet.** A minimum of a 36" wide cabinet shall be permitted under a kitchen sink or cooktop, provided the cabinetry can be removed.

#### ANSI A117.1 – 2009

**1002 Accessible Units** (*Nothing on Kitchens – Sink, cabinet.*)

#### ANSI A117.1 – 2009

**1003 Type A Units** (*Nothing on Kitchens - Sink, cabinet, See Clear Floor Space*)

**1003.12.4.1 Clear Floor Space.** A clear floor space, positioned for a forward approach to the sink, shall be provided. Knee and toe clearance complying with Section 306 shall be provided.

#### **EXCEPTIONS:**

1. The requirement for knee and toe clearance shall not apply to more than one bowl of a multi-bowl sink.
2. Cabinetry shall be permitted to be added under the sink, provided the following criteria are met:
  - (a) The cabinetry can be removed without removal or replacement of the sink,
  - (b) The floor finish extends under the cabinetry, and
  - (c) The walls behind and surrounding the cabinetry are finished.

#### ANSI A117.1 – 2009

**1004 Type B Units** (*Nothing on Kitchens – Sink, cabinets.*)

#### Fair Housing Accessibility Guidelines

**100.205(c)(7)(1).** Usable kitchens would meet section 100.205 (c) (3) (iv) if:

**100.205(c)(7)(1)(c).** In U-shaped kitchens with sink or range or cooktop at the base of the "U", a 60 – inch turning radius is provided to allow parallel approach, or base cabinets are removable at that location to allow knee space for a forward approach.

**2012 MI Building Code** (*Nothing on Kitchens – Sink, cabinets.*)

**2015 MI Residential Code**

## Section P701 Fixtures, Faucets and Fixture Fittings

### P2705 Installation

8/8/2016 10:04:11 AM

[www.zerostep.org](http://www.zerostep.org)

Appendix B: Code Comparisons 200

**P2705.1 General.** The installation of fixtures shall conform to the following:

5. Water closets, lavatories and bidets. A water closet, lavatory or bidet shall not be set closer than 15 inches (381 mm) from its center to any side wall, partition or vanity or closer than 30 inches (762 mm) center-to-center between adjacent fixtures. There shall be at least a 21-inch (533 mm) clearance in front of the water closet, lavatory or bidet to any wall, fixture or door.

**601.6 Counter Width.** A minimum 18" width of counter space is located near all ovens and the refrigerator.

**ANSI A117.1 – 2009**

**1002 Accessible Units** *(Nothing on Kitchens – Counter Width.)*

**ANSI A117.1 – 2009**

**1003 Type A Units**

**1003.12.3 Work Surface.** At least one section of counter shall provide a work surface 30 inches (760 mm) minimum in length complying with Section 1003.12.3. *(Nothing on counter width near ovens and refrigerator.)*

**ANSI A117.1 – 2009**

**1004 Type B Units** *(Nothing on Kitchens – Counter Width.)*

**Fair Housing Accessibility Guidelines** *(Nothing on Kitchens – Counter Width.)*

**2012 MI Building Code** *(Nothing on Kitchens – Counter Width.)*

**2015 MI Residential Code** *(Nothing on Kitchens - Counter Width.)*

**601.7 Sink Exposed Pipes and Surfaces.** Water supply and drain pipes under sinks shall be configured to protect against contact. There shall be no sharp or abrasive surfaces under sinks.

**ANSI A117.1 – 2009**

**606 Lavatories and Sinks.** (See [606.6](#).)

**606.6 Exposed Pipes and Surfaces.** Water supply and drainpipes under lavatories and sinks shall be insulated or otherwise configured to protect against contact. There shall be no sharp or abrasive surfaces under lavatories and sinks.

**ANSI A117.1 – 2009**

**1002 Accessible Units**

**1002.12 Kitchens.** Kitchens shall comply with Section 804. At least one work surface, 30 inches (760 mm) minimum in length, shall comply with Section 902.

**804.4 Sinks.** Sinks shall comply with Section 606. (See [606.6](#).)

**ANSI A117.1 – 2009**

**1003 Type A Units**

8/8/2016 10:04:11 AM

[www.zerostep.org](http://www.zerostep.org)

Appendix B: Code Comparisons 201

**1003.12.4.4 Exposed Pipes and Surfaces.** Water supply and drain pipes under sinks shall be insulated or otherwise configured to protect against contact. There shall be no sharp or abrasive surfaces under sinks.

**ANSI A117.1 – 2009**

**1004 Type B Units** *(Nothing on Kitchens – Sink Exposed Pipes and Surfaces.)*

**Fair Housing Accessibility Guidelines** *(Nothing on Kitchens – Sink Exposed Pipes and Surfaces.)*

**2012 MI Building Code** *(Nothing on Kitchens – Sink Exposed Pipes and Surfaces.)*

**2015 MI Residential Code** *(Nothing on Kitchens - Sink Exposed Pipes and Surfaces.)*

**601.8 Underneath Range / Cooktop Exposed Hot Surfaces.** Where knee space is provided, the underside of the range or cooktop shall be protected.

**ANSI A117.1 – 2009**

**1002 Accessible Units**

**1002.12 Kitchens.** Kitchens shall comply with Section 804. (See [804.6.4](#).)

**ANSI A117.1 – 2009**

**1003 Type A Units**

**1003.12.5.4. Cooktop.** Cooktops shall comply with Section 1003.12.5.4.

**1003.12.5.4.1 Approach.** A clear floor space positioned for a parallel or forward approach to the cooktop shall be provided.

**1003.12.5.4.2 Forward approach.** Where the clear floor space is positioned for a forward approach, knee and toe clearance complying with [Section 306](#) shall be provided. The underside of the cooktop shall be insulated or otherwise configured to protect from burns, abrasions, or electrical shock.

**ANSI A117.1 – 2009**

**1004 Type B Units**

**1004.12.2.3 Cooktop.** Cooktops shall comply with Section 1004.12.2.3.

**1004.12.2.3.1 Approach.** A clear floor space, positioned for a parallel or forward approach to the cooktop, shall be provided.

**1004.12.2.3.2 Forward approach.** Where the clear floor space is positioned for a forward approach, knee and toe clearance complying with [Section 306](#) shall be provided. The underside of the cooktop shall be insulated or otherwise configured to prevent burns, abrasions, or electrical shock.

**Fair Housing Accessibility Guidelines** *(Nothing on Kitchen – Underneath Range / Cooktop Exposed Hot Surfaces.)*

**2012 MI Building Code** *(Nothing on Kitchen – Underneath Range / Cooktop Exposed Hot Surfaces.)*

**2015 MI Residential Code**

8/8/2016 10:04:11 AM

[www.zerostep.org](http://www.zerostep.org)

Appendix B: Code Comparisons 202

## Section M1901 Ranges and Ovens

**M1901.1 Clearances.** Freestanding or built-in ranges shall have a vertical clearance above the cooking top or not less than 30 inches (762 mm) to unprotected combustible material. Reduced clearances are permitted in accordance with the listing and labeling of the range hoods or appliance or microwave even over a listed and labeled cooking appliance shall be in accordance with section M1504.1. The clearances for a domestic open-top broiler unit shall be in accordance with Section M1505.1.

**601.9 Accessible Walk-In Pantries.** Lighting shall be installed in walk-in pantries.

**ANSI A117.1 – 2009**

**1002 Accessible Units** *(Nothing on Kitchens – Accessible Walk-In Pantries.)*

**ANSI A117.1 – 2009**

**1003 Type A Units** *(Nothing on Kitchens – Accessible Walk-In Pantries.)*

**ANSI A117.1 – 2009**

**1004 Type B Units** *(Nothing on Kitchens – Accessible Walk-In Pantries.)*

**Fair Housing Accessibility Guidelines** *(Nothing on Kitchens – Accessible Walk-In Pantries.)*

**2012 MI Building Code** *(Nothing on Kitchens – Accessible Walk-In Pantries.)*

**2015 MI Residential Code** *(Nothing on Kitchens - Accessible Walk-in Pantries.)*

**These requirements are derived from the most recent edition of The ANSI Reference Codes, The Fair Housing Guidelines, The Michigan Building Codes and The Michigan Residential Codes. As these codes are updated, so too will the ZeroStep™ Guidelines.**

**The next edition of the ANSI Reference Codes is planned to increase the clear floor spaces from 48-inches by 48-inches to 52-inches by 52-inches. The clear turning spaces are also planned to be increased from 60-inches in diameter to 67-inches in diameter. When the new editions are released, the ZeroStep™ Guidelines will be revised. Disability Advocates of Kent County recommends that these changes be considered in current construction design.**



## Chapter 7. Laundry Room

The contents of this section define what a ZeroStep™ laundry room is. Following each ZeroStep™ guidelines section are provided references to the most recent edition of The ANSI Reference Codes, The Fair Housing Guidelines, The Michigan Building Codes, and The Michigan Residential Codes, from which the measures and dimensions requirements were derived and expanded upon.

### 701 Laundry Room

**701.1 Location.** The laundry area shall be on an accessible route.

**ANSI A117.1 – 2009**  
**1002 Accessible Units**

**1002.3 Accessible Route.** Accessible routes within Accessible units shall comply with Section 1002.3.

**ANSI A117.1 – 2009**  
**1003 Type A Units**

**1003.3 Accessible Route.** Accessible routes within Type A units shall comply with Section 1003.3.

**ANSI A117.1 – 2009**  
**1004 Type B Units**

**1004.3 Accessible Route.** Accessible routes within Type B units shall comply with Section 1004.3. (See [1004.3.1](#) and [1004.3.2](#).)

#### **Fair Housing Accessibility Guidelines**

See Section [100.205\(c\)\(1\)](#).

#### **Guideline**

The following chart identifies the public and common use areas that should be made accessible, cites the appropriate section of the ANSI Standard, and describes the appropriate application of the specifications, including modifications to the referenced Standard.

(ANSI A117.1 – 1986.) If provided in the facility or at the site, at least one of each type of appliance provided in each laundry area, except that laundry rooms serving covered multifamily dwellings would not be required to have front-loading

washer in order to meet the requirements of 100.205 (c ) (1). (Where front loading washers are not provided, management will be expected to provide assistive devices on request if necessary to permit a resident to use a top loading washer.)

**2012 MI Building Code** *(Nothing on Laundry Room – Location.)*

**2015 MI Residential Code** *(Nothing on Laundry Room - Location.)*

**701. 2 Clear Floor Space.** A 48" x 48" minimum clear floor space shall be provided at the washing machine, clothes dryer and laundry tub. Clear floor spaces may overlap. If there is a swing door or other type of door, it may overlap the appliance clear floor space.

**ANSI A117.1 – 2009**

**611 Washing Machines and Clothes Dryers**

**611.1 General.** Accessible washing machines and clothes dryers shall comply with Section 611.

**611.2 Clear Floor Space.** A clear floor space complying with [Section 305](#), positioned for parallel approach, shall be provided. For top loading machines, the clear floor space shall be centered on the appliance. For front loading machines, the centerline of the clear floor space shall be offset 24 inches (610 mm) maximum from the centerline of the door opening.

**ANSI A117.1 – 2009**

**1002 Accessible Units**

**1002.10 Laundry Equipment.** Washing machines and clothes dryers shall comply with Section 611. (See [611.2](#).)

**ANSI A117.1 – 2009**

**1003 Type A Units**

**1003.10 Laundry Equipment.** Washing machines and clothes dryers shall comply with Section 611. (See [611.2](#).)

**ANSI A117.7.1 – 2003**

**1004 Type B Units**

**1004.10 Laundry Equipment.** Washing machines and clothes dryers shall comply with Section 1004.10.

**1004.10.1 Clear Floor Space.** A clear floor space complying with [Section 305.3](#), shall be provided. A parallel approach shall be provided for a top loading machine. A forward or parallel approach shall be provided for a front loading machine.

**Fair Housing Accessibility Guidelines** *(Nothing on Laundry Room – Clear Floor Space.)*

**2012 MI Building Code** *(Nothing on Laundry Room – Clear Floor Space.)*

**2015 MI Residential Code** *(Nothing on Laundry Room - Clear Floor Space.)*



**701.3 Turning Space.** If the laundry appliances are located in a room, a 5' diameter turning space shall be provided.

**ANSI A117.1 – 2009**

**302 Floor Surfaces**

**302.1 General.** Floor surface shall be stable, firm and slip resistant and shall comply with Section 302. Changes in level in floor surfaces shall comply with Section 303.

**302.2 Carpet.** Carpet or carpet tile shall be securely attached and shall have a firm cushion, pad, or backing or no cushion or pad. Carpet or carpet tile shall have a level loop, textured loop, level cut pile, or level cut/uncut pile texture. The pile shall be ½ inch (13 mm) maximum in height. Exposed edges of carpet shall be fastened to the floor and shall have trim along the entire length of the exposed edge. Carpet edge trim shall comply with Section 303. (See [303.1](#), [303.2](#), [303.3](#).)

**302.3 Openings.** Openings in floor surfaces shall be of a size that does not permit the passage of a ½ inch (13 mm) diameter sphere, except as allowed in Sections 407.4.3, 408.4.3, 409.4.3, 410.4, and 805.10. Elongated openings shall be placed so that the long dimension is perpendicular to the dominant direction of travel.

**304 Turning Space**

**304.1 General.** A turning space shall comply with Section 304.

**304.2 Floor Surface.** Floor surfaces of a turning space shall comply with Section 302. Changes in level are not permitted within the turning space. (See [302.1](#), [302.2](#), and [302.3](#).)

**EXCEPTION:** Slopes not steeper than 1:48 shall be permitted.

**304.3 Size.** Turning spaces shall comply with Section 304.3.1 or 304.3.2.

**304.3.1 Circular Space.** The turning space shall be a circular space with a 60–inch (1525 mm) minimum diameter. The turning space shall be permitted to be knee and toe clearance complying with Section 306.

**304.3.2 T–Shaped Space.** The turning space shall be a T–shaped space within a 60–inch (1525 mm) minimum square, with arms and base 36 inches (915 mm) minimum in width. Each arm of the T shall be clear of obstructions 12 inches (305 mm) minimum in each direction, and the base shall be clear of obstructions 24 inches (610 mm) minimum. The turning space shall be permitted to be knee and toe clearance complying with Section 306. Only at the end of either the base or one arm.

**304.4 Door Swing.** Unless otherwise specified, doors shall be permitted to swing into turning spaces.

**ANSI A117.1 – 2009**

**1002 Accessible Units**

**1002.3 Accessible Route.** Accessible routes within Accessible units shall comply with Section 1002.3.

**1002.3.1 Location.** At least one accessible route shall connect all spaces and elements that are a part of the unit. Accessible routes shall coincide with or be located in the same general circulation.

**EXCEPTION:** An accessible route is not required to unfinished attics and unfinished basements that are part of the

unit.

**1002.3.2 Turning Space.** All rooms served by an accessible route shall provide a turning space complying with Section 304.

**EXCEPTION:**

1. A turning space shall not be required in toilet rooms and bathrooms that are not required to comply with Section 1002.11.2.
2. A turning space is not required within closets or pantries that are 48 Inches (1220 mm) maximum in depth.

**1002.3.3 Components.** Accessible routes shall consist of one or more of the following elements: walking surfaces with a slope not steeper than 1:20, doors and doorways, ramps, elevators, and platform lifts.

**ANSI A117.1 – 2009**

**1003 Type A Units**

**1003.3 Accessible Route.** Accessible routes within Type A units shall comply with Section 1003.3.

**1003.3.1 Location.** At least one accessible route shall connect all spaces and elements that are a part of the unit. Accessible routes shall coincide with or be located in the same area as a general circulation path.

**EXCEPTION:** An accessible route is not required to unfinished attics and unfinished basements that are part of the unit.

**1003.3.2 Turning Space.** All rooms served by an accessible route shall provide a turning space complying with Section 304.

**EXCEPTIONS:**

1. A turning space is not required in toilet rooms and bathrooms that are not required to comply with Section 1003.11.2.
2. A turning space is not required within closets or pantries that are 48 inches (1220 mm) maximum in depth.

**1003.3.3 Components.** Accessible routes shall consist of one or more of the following elements: walking surfaces with a slope not steeper than 1:20, doors and doorways, ramps, elevators, and platform lifts.

**2012 MI Building Code** (*Nothing on Laundry Room – Turning Spaces.*)

**2015 MI Residential Code** (*Nothing on Laundry Room – Turning Spaces.*)

**701. 4 Doors.** Doors shall comply with Section 201.

**ANSI A117.1 – 2009**

**1002 Accessible Units**

**1002.5 Doors and Doorways.** The primary entrance door to the unit, and all other doorways intended for user passage, shall comply with Section 404.

**ANSI A117.1 – 2009**

**1003 Type A Units**

8/8/2016 10:04:11 AM

[www.zerostep.org](http://www.zerostep.org)

**1003.5 Doors and Doorways.** The primary entrance door to the unit, and all other doorways intended for user passage, shall comply with Section 404.

**ANSI A117.1 – 2009**

**1004 Type B Units**

**1004.5 Doors and Doorways.** Doors and doorways shall comply with Section 1004.5.

**Fair Housing Accessibility Guidelines**

See Section ~~100.205(c)(2)(2)~~

**2012 MI Building Code** (*Nothing on Laundry Room – Doors.*)

**Section 1008 Gates Doors and Turnstiles.**

**1008.1. Doors.**

**1008.1.1 Size of Doors.** The minimum width of each door opening shall be sufficient for the occupant load thereof and shall provide a clear width of 32 Inches (813 mm).

**2015 MI Residential Code**

**Section 311 Means of Egress**

**R311.2.1 Interior Doors.** Interior doors shall not be less than 24 inches (609 mm) in width and 6 feet, 6 Inches (1980 mm) in height.

**EXCEPTION:** Doors to areas less than 10 square feet of floor area.

**These requirements are derived from the most recent edition of The ANSI Reference Codes, The Fair Housing Guidelines, The Michigan Building Codes and The Michigan Residential Codes. As these codes are updated, so too will the ZeroStep™ Guidelines.**

**The next edition of the ANSI Reference Codes is planned to increase the clear floor spaces from 48-inches by 48-inches to 52-inches by 52-inches. The clear turning spaces are also planned to be increased from 60-inches in diameter to 67-inches in diameter. When the new editions are released, the ZeroStep™ Guidelines will be revised. Disability Advocates of Kent County recommends that these changes be considered in current construction design.**



## Chapter 8. Living Room

The contents of this section define what a ZeroStep™ living room is. Following each ZeroStep™ guidelines section are provided references to the most recent edition of The ANSI Reference Codes, The Fair Housing Guidelines, The Michigan Building Codes, and The Michigan Residential Codes, from which the measures and dimensions requirements were derived and expanded upon.

### 801 Living Room

**801.1 Location.** There shall be at least one living/family room on the main floor, on an accessible route.

**ANSI A117.1 – 2009**  
**1002 Accessible Units**

**1002.3 Accessible Route.** Accessible routes within Accessible units shall comply with Section 1002.3.

**ANSI A117.1 – 2009**  
**1003 Type A Units**

**1003.3 Accessible Route.** Accessible routes within Type A units shall comply with Section 1003.3.

**ANSI A117.1 – 2009**  
**1004 Type B Units**

**1004.3 Accessible Route.** Accessible routes within Type B units shall comply with Section 1004.3. (See [1004.3.1](#) and [1004.3.2](#).)

**Fair Housing Accessibility Guidelines**

See Section [100.205\(c\)\(3\)\(i\)](#), Section [100.205\(c\)\(3\)\(i\)\(1\)](#), Section [100.205\(c\)\(3\)\(i\)\(2\)](#), and Section [100.205\(c\)\(3\)\(i\)\(4\)](#).

**2012 MI Building Code**

**Section 1107 Dwelling Units and Sleeping Units**

See [1107.1](#), [1107.2](#), and [1107.3](#).

**2015 MI Residential Code** (*Nothing on Living Rooms – Location.*)

**801.2 Turning Space.** There shall be a 5' diameter turning space.

**ANSI A117.1 – 2009**  
**1002 Accessible Units**

**1002.3.2 Turning space.** All rooms served by an accessible route shall provide a turning space complying with Section 304. (See [304.1](#), [304.2](#), [304.3](#), and [304.4](#).)

**ANSI A117.1 – 2009**  
**1003 Type A Units**

**1003.3.2 Turning space.** All rooms served by an accessible route shall provide a turning space complying with Section 304. (See [304.1](#), [304.2](#), [304.3](#), and [304.4](#).)

**ANSI A117.1 – 2009**  
**1004 Type B Units** (*Nothing on Living Rooms – Turning Space.*)

**Fair Housing Accessibility Guidelines** (*Nothing on Living Rooms – Turning Space.*)

**2012 MI Building Code** (*Nothing on Living Rooms – Turning Space.*)

**2015 MI Residential Code** (*Nothing on Living Rooms – Turning Space.*)

**801.3 Changes in Level.** Shall comply with [Section 104.3](#).

**ANSI A117.1 – 2009**  
**1002 Accessible Units**

**1002.4 Walking Surfaces.** Walking surfaces that are part of an accessible route shall comply with Section 403. (See [403.4](#), [303.1](#), [303.2](#), and [303.3](#).)

**ANSI A117.1 – 2009**  
**1003 Type A Units**

**1003.4 Walking Surfaces.** Walking surfaces that are part of an accessible route shall comply with Section 403. (See [403.4](#), [303.1](#), [303.2](#), and [303.3](#).)

**ANSI A117.1 – 2009**  
**1004 Type B Units**

**1004.4.2 Changes in Level.** Changes in level shall comply with Section 303. (See [303.1](#), [303.2](#), and [303.3](#).)

**Fair Housing Accessibility Guidelines**

See Section [100.205\(c\)\(3\)\(i\)\(2\)](#), [100.205\(c\)\(3\)\(i\)\(4\)](#).

**2012 MI Building Code** (*Nothing on Living Rooms – Changes in Level.*)

2015 MI Residential Code (Nothing on Living Rooms - Changes in Level.)

**801.4 Doors.** Doors shall comply with Section 201.

ANSI A117.1 – 2009

**1002 Accessible Units**

**1002.5 Doors and Doorways.** The primary entrance door to the unit, and all other doorways intended for user passage, shall comply with Section 404.

ANSI A117.1 – 2009

**1003 Type A Units**

**1003.5 Doors and Doorways.** The primary entrance door to the unit, and all other doorways intended for user passage, shall comply with Section 404.

ANSI A117.1 – 2009

**1004 Type B Units**

**1004.5 Doors and Doorways.** Doors and doorways shall comply with Section 1004.5. (See 1004.5.2, 1004.5.2.1, 1004.5.2, 1004.5.2, 1004.5.2.3, 1004.5.2.4.)

**Fair Housing Accessibility Guidelines**

See Section 100.205(c)(2)(2).

**2012 MI Building Code**

**Section 1107 Dwelling Units and Sleeping Units**

See 1107.2.

**Section 1008 Doors, Gates and Turnstiles**

See 1008.1 and 1008.1.1.)

**2015 MI Residential Code**

**Section 311 Means of Egress**

**R311.2.1 Interior Doors.** Interior doors shall not be less than 24 inches (609 mm) in width and 6 feet, 6 Inches (1980 mm) in height.

**EXCEPTION:** Doors to areas less than 10 square feet of floor area.

**801.5 Flooring.** Shall comply with Section 901.

ANSI A117.1 – 2009

8/8/2016 10:04:11 AM

www.zerostep.org

## 1002 Accessible Units

**1002.4 Walking Surfaces.** Walking surfaces that are part of an accessible route shall comply with Section 403.

**403.2 Floor Surface.** Floor surfaces shall comply with Section 302. (See [302.1](#), [302.2](#), and [302.3.3](#).)

## ANSI A117.1 – 2009

### 1003 Type A Units.

**1003.4 Walking Surfaces.** Walking surfaces that are part of an accessible route shall comply with Section 403.

**403.2 Floor Surface.** Floor surfaces shall comply with Section 302. (See [302.1](#), [302.2](#), and [302.3.3](#).)

## ANSI A117.1 – 2009

### 1004 Type B Units *(Nothing on Flooring – Floor Surfaces.)*

## Fair Housing Accessibility Guidelines

See Section [100.205\(c\)\(1\)](#).

### Guideline

The following chart identifies the public and common use areas that should be made accessible, cites the appropriate section of the ANSI Standard, and describes the appropriate application of the specifications, including modifications to the referenced Standard.

(ANSI A117.1 – 1986.) 4.5 Ground and floor surface treatments: Accessible routes, rooms, and spaces, including floors, walks, ramps, stairs, and curb ramps.

## 2012 MI Building Code

### Section 804 Internal Floor Finish

**804.1 General.** Interior floor finish and floor covering materials shall comply with Sections 804.2 through 804.4.2.

**EXCEPTION:** Floor finishes and coverings of a traditional type, such as wood, vinyl, linoleum or terrazzo, and resilient floor covering materials that are not comprised of fibers.

### Section 1210. Toilet and Bathroom Requirements

#### 12010.2 Finish materials.

**1210.2.1 Floors and wall bases.** In other than dwelling units, toilet and bathing and shower room floor finish material shall have a smooth, hard, nonabsorbent surface. The intersections of such floors and walls shall have a smooth, hard, nonabsorbent vertical base that extends upward onto the walls at least 4 inches (102 mm).

## 2015 MI Residential Code *(Nothing on Living Rooms – Flooring.)*

**These requirements are derived from the most recent edition of The ANSI Reference Codes, The Fair Housing Guidelines, The Michigan Building Codes and The Michigan**

8/8/2016 10:04:11 AM

[www.zerostep.org](http://www.zerostep.org)

Appendix B: Code Comparisons 212

**Residential Codes.** As these codes are updated, so too will the ZeroStep™ Guidelines. The next edition of the ANSI Reference Codes is planned to increase the clear turning spaces from 60-inches in diameter to 67-inches in diameter. When the new editions are released, the ZeroStep™ Guidelines will be revised. Disability Advocates of Kent County recommends that these changes be considered in current construction design.





## Chapter 9. Flooring

The contents of this section define what a ZeroStep™ floor surface is. Following each ZeroStep™ guidelines section are provided references to the most recent edition of The ANSI Reference Codes, The Fair Housing Guidelines, The Michigan Building Codes, and The Michigan Residential Codes, from which the measures and dimensions requirements were derived and expanded upon.

### 901 Flooring

**901.1 Changes in Level.** Shall comply with Section 104.3.

**ANSI A117.1 – 2009**  
**1002 Accessible Units**

**1002.3 Accessible Route.** Accessible routes within Accessible units shall comply with Section 1002.3.

**ANSI A117.1 – 2009**  
**1003 Type A Units**

**1003.3 Accessible Route.** Accessible routes within Type A units shall comply with Section 1003.3.

**Type B Units**

**1004.4 Walking Surfaces.** Walking surfaces that are part of an accessible route shall comply with Section 1004.4. (See [1004.4.2](#).)

**Fair Housing Accessibility Guidelines**

See Section [100.205\(c\)\(3\)\(i\)](#), Section [100.205\(c\)\(3\)\(ii\)\(2\)](#), Section [100.205\(c\)\(3\)\(ii\)\(4\)](#), Section [100.205\(c\)\(3\)\(ii\)\(5\)](#) and Section [100.205\(c\)\(3\)\(ii\)\(6\)](#).

**2009 MI Building Code**

**Section 1008 Doors, Gates and Turnstiles.**

See [1008.1.4](#).

**2012 MI Building Code** (*Nothing on Flooring - Changes in Level.*)

**Commented [JB1]:** Not quite sure why this is being cited. It deals with landings.

2015 MI Residential Code *(Nothing on Flooring - Changes in Level.)*

**901.2 Floor Registers.** Shall comply with Section 901.1 or shall be flush with the floor.

**ANSI A117.1 – 2009**

**1002 Accessible Units**

**1002.3 Accessible Route.** Accessible routes within Accessible units shall comply with Section 1002.3.

**ANSI A117.1 – 2009**

**1003 Type A Units**

**1003.3 Accessible Route.** Accessible routes within Type A units shall comply with Section 1003.3.

**ANSI A117.1 – 2009**

**1400 Type B Units**

**1004.4 Walking Surfaces.** Walking surfaces that are part of an accessible route shall comply with Section 1004.4. (See 1004.4.2.)

**Fair Housing Accessibility Guidelines** *(Nothing on Floor – Floor Registers.)*

**2009 MI Building Code** *(Nothing on Floor – Floor Registers.)*

**2015 MI Residential Code** *(Nothing on Floor – Floor Registers.)*

**These requirements are derived from the most recent edition of The ANSI Reference Codes, The Fair Housing Guidelines, The Michigan Building Codes and The Michigan Residential Codes. As these codes are updated, so too will the ZeroStep™ Guidelines.**



## Chapter 10. Windows

The contents of this section define what a ZeroStep™ walkway or pathway is. Following each ZeroStep™ guidelines section are provided references to the most recent edition of The ANSI Reference Codes, The Fair Housing Guidelines, The Michigan Building Codes, and The Michigan Residential Codes, from which the measures and dimensions requirements were derived and expanded upon.

### 1001 Windows

ANSI A117.1 – 2009

#### 506 Windows

**506.1 General.** Accessible windows shall have operable parts complying with Section 309.

#### 309 Operable Parts

**309.1 General.** Operable parts required to be accessible shall comply with Section 309.

**309.2 Clear Floor Space.** A clear floor space complying with Section 305 shall be provided.

**309.3 Height.** Operable parts shall be placed within one or more of the reach ranges specified in Section 308.

#### 308.2 Forward Reach.

**308.2.1 Unobstructed.** Where a forward reach is unobstructed, the high forward reach shall be 48 inches (1220 mm) maximum and the low forward reach shall be 15 inches (380 mm) minimum above the floor.

**308.2.2 Obstructed High Reach.** Where a high forward reach is over an obstruction, the clear floor space shall extend beneath the element for a distance not less than the required reach depth over the obstruction. The high forward reach shall be 48 inches (1220 mm) maximum where the reach depth is 20 inches (510 mm) maximum. Where the reach depth exceeds 20 inches (510 mm), the high forward reach shall be 44 inches (1120 mm) maximum, and the reach depth shall be 25 inches (635 mm) maximum.

#### 308.3 Side Reach.

**308.3.1 Unobstructed.** Where a clear floor space complying with Section 305 allows a parallel approach to an element and the edge of the clear floor space is 10 inches (255 mm) maximum from the element, the high side reach shall be 48 inches (1220 mm) maximum and the low side reach shall be 15 inches (380 mm) minimum above the floor.

8/8/2016 10:04:11 AM

[www.zerostep.org](http://www.zerostep.org)

Appendix B: Code Comparisons 216

**EXCEPTION:** Existing elements that are not altered shall be permitted at 54 inches (1370 mm) maximum above the floor.

**308.3.2 Obstructed High Reach.** Where a clear space complying with Section 305 allows a parallel approach to an element and the high side reach is over an obstruction, the height of the obstruction shall be 34 inches (865 mm) maximum and the depth of the obstruction shall be 24 inches (610 mm) maximum. The high side reach shall be 48 inches (1220 mm) maximum for a reach depth of 10 inches (255 mm) maximum. Where the reach depth exceeds 10 inches (255 mm), the high side reach shall be 46 inches (1170 mm) maximum for a reach depth of 24 inches (610 mm) maximum.

**309.4 Operation.** Operable parts shall be operable with one hand and shall not require tight grasping, pinching, or twisting of the wrist. The force required to activate operable parts shall be 5.0 pounds (22.2 N) maximum.

#### ANSI A117.1 – 2009

##### 1002 Accessible Units

**1002.13 Windows.** Windows shall comply with Section 1002.13.

**1002.13.1 Natural ventilation.** Operable windows required to provide natural ventilation shall comply with [Sections 309.2](#) and [309.3](#).

**1002.13.2 Emergency escape.** Operable windows required to provide an emergency escape and rescue opening shall comply with [Section 309.2](#).

**1002.9 Operable Parts.** Lighting controls, electrical panelboards, electrical switches and receptacle outlets, environmental controls, appliance controls, operating hardware for operable windows, plumbing fixture controls, and user controls for security or intercom systems shall comply with [Section 309](#).

#### ANSI A117.1 – 2009

##### 1003 Type A Units

**1003.13 Windows.** Windows shall comply with Section 1003.13.

**1003.13.1 Natural ventilation.** Operable windows required to provide natural ventilation shall comply with [Sections 309.2](#) and [309.3](#).

**1003.13.2 Emergency escape.** Operable windows required to provide an emergency escape and rescue opening shall comply with [Section 309.2](#).

**1003.9 Operable Parts.** Lighting controls, electrical panelboards, electrical switches and receptacle outlets, environmental controls, appliance controls, operating hardware for operable windows, plumbing fixture controls, and user controls for security or intercom systems shall comply with [Section 309](#).

#### ANSI A117.1 – 2009

##### 1004 Type B Units *(Nothing on Windows)*

##### Fair Housing Accessibility Guidelines *(Nothing on Windows)*

#### 2012 MI Building Code

##### Section 1029 Emergency Escape and Rescue

**1029.2 Minimum Size.** Emergency escape and rescue openings shall have a minimum net clear open of 5.7 square feet (0.53 m<sup>2</sup>)

**EXCEPTION:** The minimum net clear opening for grade floor emergency escape and rescue openings shall be 5 square feet (0.46 m<sup>2</sup>).

**1029.2.1 Minimum Dimensions.** The minimum net clear opening height dimension shall be 24 inches (610 mm). The minimum net clear opening width dimension shall be 20 inches (508 mm). The net clear opening dimensions shall be the result of normal operation of the opening.

**1029.5 Window Wells.** An emergency escape and rescue opening with a finished sill height below the adjacent ground level shall be provided with a window well in accordance with Sections 1029.5.1 and 1029.5.2.

**1029.5.1 Minimum size.** The minimum horizontal area of the window well shall be 9 square feet (0.84 m<sup>2</sup>), with a minimum dimension of 36 inches (914 mm). The area of the window well shall allow the emergency escape and rescue opening to be fully opened.

#### Section 1109 Other Features and Facilities

**1109.13. Controls, operating mechanisms and hardware.** Controls, operating mechanisms and hardware intended for operation by the occupant, including switches that control lighting and ventilation and electrical convenience outlets, in accessible spaces, along accessible routes or as parts of accessible elements shall be accessible.

**1109.13.1 Operable window.** Where operable windows are provided in rooms that are required to be accessible in accordance with Sections 1107.5.1.1, 1107.5.2.1, 1107.5.3.1, 1107.5.4, 1107.6.1.1, 1107.6.2.2.1, and 1107.6.4.1 at least one window in each room shall be accessible and each required operable window shall be accessible.

**EXCEPTION:** Accessible windows are not required in bathrooms or kitchens.

#### Section 1205 Lighting

**1205.2 Natural light.** The minimum net glazed area shall not be less than 8 percent of the floor area of the room served.

**1205.2.1 Adjoining spaces.** For the purpose of natural lighting, any room is permitted to be considered as a portion of an adjoining room where one-half of the area of the common wall is open and unobstructed and provides an opening of not less than one-tenth of the floor area of the interior room or 25 square feet (2.32 m<sup>2</sup>), whichever is greater.

**EXCEPTION:** Openings required for natural light shall be permitted to open into a sun room with a thermal isolation or a patio cover where the common wall provides a glazed area of not less than one-tenth of the floor area of the interior room or 20 square feet (1.86 m<sup>2</sup>), whichever is greater.

**1205.2.2 Exterior openings.** Exterior openings required by Section 1205.2 for natural light shall open directly onto a public way, yard or court, as set forth in Section 1206.

**EXCEPTIONS:**

1. Required exterior openings are permitted to open into a roofed porch where the porch:
  - 1.1 Abuts a public way, yard or court.
  - 1.2 Has a ceiling height of not less than 7 feet (2134 mm).

- 1.3 Has a longer side at least 65 percent open and unobstructed.
2. Skylights are not required to open directly onto a public way, yard or court.

## 2015 MI Residential Code

### Section R303 Light Ventilation and Heating

**R303.1 Habitable rooms.** Habitable rooms shall have an aggregate glazing area of not less than 8 percent of the floor area of such rooms. Natural ventilation shall be through windows, doors, louvers or other approved openings to the outdoor air. Such openings shall be provided with ready access or shall otherwise be readily controllable by the building occupants. The openable area to the outdoors shall be not less than 4 percent of the floor area being ventilated.

### Section R310 Emergency Escape and Rescue Openings

**R310.1. Emergency escape and rescue opening requirement.** Basements, habitable attics and every sleeping room shall have not less than one operable emergency escape and rescue opening. Where basements contain one or more sleeping rooms, and emergency escape and rescue opening shall be required in each sleeping room. Emergency escape and rescue openings shall open directly into a public way, or to a yard or court that opens to a public way.

**Exception:** Storm shelters and basements used only to house mechanical equipment not exceeding a total floor area of 200 square feet (18.58 m<sup>2</sup>)

**R310.1.1 Operational constraints and opening control devices.** Emergency escape and rescue openings shall be operational from the inside of the room without the use of keys, tools or special knowledge. Window opening control devices complying with ASTM F2090 shall be permitted for use on windows serving as a required emergency escape and rescue opening.

**R310.2 Emergency escape and rescue openings.** Emergency escape and rescue openings shall have the minimum dimensions as specified in this section.

**R310.2.1 Minimum opening area.** Emergency and rescue escape openings shall have a net clear opening of not less than 5.7 square feet (0.530 m<sup>2</sup>). The net clear opening dimensions required by this section shall be obtained by the normal operation of the emergency escape and rescue opening from the inside. The net clear height opening shall be not less than 24 inches (610 mm) and the net clear width shall be not less than 20 inches (508 mm).

**Exception: Grade floor or below grade openings shall have a net clear opening of not less than 5 square feet (0.465 m<sup>2</sup>).**

**R310.2.2 Window sill height.** Where a window is provided as the emergency escape and rescue opening, it shall have a sill height of not more than 44 inches (1118 mm) above the floor; where the sill height is below grade, it shall be provided with a window well in accordance with Section R310.2.3.

**These requirements are derived from the most recent edition of The ANSI Reference Codes, The Fair Housing Guidelines, The Michigan Building Codes and The Michigan Residential Codes. As these codes are updated, so too will the ZeroStep™ Guidelines.**



## Chapter 11. Lighting

The contents of this section define what a ZeroStep™ lighting configuration is. Following each ZeroStep™ guidelines section are provided references to the most recent edition of The ANSI Reference Codes, The Fair Housing Guidelines, The Michigan Building Codes, and The Michigan Residential Codes, from which the measures and dimensions requirements were derived and expanded upon.

### 1101 Lighting

**1101.1 Exterior Lighting.** Exterior lighting shall be provided near all entrances so things such as the front door, porch, keyhole, keypad and house number are clearly visible. See Section 105 Opt.2.

**ANSI A117.1 – 2009**

**1002 Accessible Units** *(Nothing on Exterior Lighting.)*

**ANSI A117.1 – 2009**

**1003 Type A Units** *(Nothing on Exterior Lighting.)*

**ANSI A117.1 – 2009**

**1004 Type B Units** *(Nothing on Exterior Lighting.)*

**Fair Housing Accessibility Guidelines** *(Nothing on Exterior Lighting.)*

**2012 MI Building Code**

**Section 1205 Lighting.**

**1205.1 General.** Every space intended for human occupancy shall be provided with natural light by means of exterior glazed openings in accordance with Section 1205.2 or shall be provided with artificial light in accordance with Section 1205.3. Exterior glazed openings shall open directly onto a public way or onto a yard or court in accordance with Section 1206.

**1205.3 Artificial light.** Artificial light shall be provided that is adequate to provide an average illumination of 10 floorcandles (107 lux) over the area of the room at a height of 30 inches (762 mm) above the floor level.

**2015 MI Residential Code**

**Section 3903 Lighting Outlets**

8/8/2016 10:04:11 AM

[www.zerostep.org](http://www.zerostep.org)

Appendix B: Code Comparisons 220

**E3903.1 General**

**E3903.2 Habitable rooms.**

**E3903.3 Additional locations.** At least one wall-switch controlled lighting outlet shall be installed in hallways, stairways, attached garages, and detached garages with electric power. At least one wall-switch-controlled lighting outlet shall be installed to provide illumination on the exterior side of each outdoor egress door for attached garages and detached garages with electric power

**These requirements are derived from the most recent edition of The ANSI Reference Codes, The Fair Housing Guidelines, The Michigan Building Codes and The Michigan Residential Codes. As these codes are updated, so too will the ZeroStep™ Guidelines.**





## Chapter 12. Lighting Controls, Electrical Switches, and Outlets

The contents of this section define what a ZeroStep™ light control, electrical switch and outlet configuration is. Following each ZeroStep™ guidelines section are provided references to the most recent edition of The ANSI Reference Codes, The Fair Housing Guidelines, The Michigan Building Codes, and The Michigan Residential Codes, from which the measures and dimensions requirements were derived and expanded upon.

### 1201 Lighting Controls, Electrical Switches, and Outlets

**1201.1 Electrical Panel Box.** The electrical panel box shall be on an accessible route.

#### ANSI A117.1 – 2009

##### 1002 Accessible Units

**1002.9 Operable Parts.** Lighting controls, electrical panelboards, electrical switches and receptacle outlets, environmental controls, appliance controls, operating hardware for operable windows, plumbing fixture controls, and user controls for security or intercom systems shall comply with [Section 309](#).

##### EXCEPTIONS:

1. Receptacle outlets serving a dedicated use.
2. Where two or more receptacle outlets are provided in a kitchen above a length of counter top that is uninterrupted by a sink or appliance, one receptacle outlet shall not be required to comply with Section 309.
3. Floor receptacle outlets.
4. HVAC diffusers.
5. Controls mounted on ceiling fans.
6. Where redundant controls other than light switches are provided for a single element, one control in each space shall not be required to be accessible.
7. Reset buttons and shut-offs serving appliances, piping and plumbing fixtures.
8. Electrical panelboards shall not be required to comply with [Section 309.4](#).

#### ANSI A117.1 – 2009

##### 1003 Type A Units

**1003.9 Operable Parts.** Lighting controls, electrical panelboards, electrical switches and receptacle outlets, environmental controls, appliance controls, operating hardware for operable windows, plumbing fixture controls, and user controls for security or intercom systems shall comply with [Section 309](#).

##### EXCEPTIONS:

1. Receptacle outlets serving a dedicated use.

2. Where two or more receptacle outlets are provided in a kitchen above a length of counter top that is uninterrupted by a sink or appliance, one receptacle outlet shall not be required to comply with Section 309.
3. Floor receptacle outlets.
4. HVAC diffusers.
5. Controls mounted on ceiling fans.
6. Where redundant controls other than light switches are provided for a single element, one control in each space shall not be required to be accessible.
7. Reset buttons and shut-offs serving appliances, piping and plumbing fixtures.
8. Electrical panelboards shall not be required to comply with [Section 309.4](#)

#### ANSI A117.1 – 2009

##### 1004 Type B Units

**1003.9 Operable Parts.** Lighting controls, electrical panelboards, electrical switches and receptacle outlets, environmental controls, appliance controls, operating hardware for operable windows, plumbing fixture controls, and user controls for security or intercom systems shall comply with [Section 309](#).

##### EXCEPTIONS:

1. Receptacle outlets serving a dedicated use.
2. Where two or more receptacle outlets are provided in a kitchen above a length of counter top that is uninterrupted by a sink or appliance, one receptacle outlet shall not be required to comply with Section 309.
3. Floor receptacle outlets.
4. HVAC diffusers.
5. Controls mounted on ceiling fans.
6. Where redundant controls other than light switches are provided for a single element, one control in each space shall not be required to be accessible.
7. Reset buttons and shut-offs serving appliances, piping and plumbing fixtures.
8. Electrical panelboards shall not be required to comply with [Section 309.4](#)

#### Fair Housing Accessibility Guidelines

**Section 100.205(c)(3)(ii)** requires that all covered multifamily dwellings with a building entrance on an accessible route shall be designed and constructed in such a manner that all premises within covered multifamily dwelling units contain light switches, electrical outlets, thermostats, and other environmental controls in accessible locations.

**Guideline** – Light switches, electrical outlets, thermostats, and other environmental controls would meet Section 100.205(c)(3)(ii) if operable parts of the controls are located no higher than 48 inches, and no lower than 15 inches, above the floor. If the reach is over an obstruction (for example, an overhanging shelf) between 20 and 25 inches in depth, the maximum height is reduced to 44 inches for forward approach; or 46 inches for side approach, provided the obstruction (for example, a kitchen base cabinet) is no more than 24 inches in depth. Obstructions should not extend more than 25 inches from the wall beneath a control.

#### 2012 MI Building Code

##### Section 1109 Other Features and Facilities

**1109.13 Controls, operating mechanisms and hardware.** Controls, operating mechanisms and hardware intended for operation by the occupant, including switches that control lighting and ventilation and electrical convenience outlets, in accessible spaces, along accessible routes or as part of accessible elements shall be accessible.

**EXCEPTIONS:**

1. Operable parts that are intended for use only by service or maintenance personnel shall not be required to be accessible. (Additional exceptions included in MBC)

**2015 MI Residential Code** (*Nothing on Lighting Controls, Electrical Switches, and outlets - Accessible Routes.*)

**1201.2 Electrical Panel Box Clear Floor Space.** A clear 32" x 48" floor space shall be provided at the electrical panel box for either a parallel or perpendicular approach.

**ANSI A117.1 – 2009**

**309 Operable Parts**

**309.1 General.** Operable parts required to be accessible shall comply with Section 309.

**309.2 Clear Floor Space.** A clear floor space complying with Section 305 shall be provided.

**309.3 Height.** Operable parts shall be placed within one or more of the reach ranges specified in Section 308.

**309.4 Operation.** Operable parts shall be operable with one hand and shall not require tight grasping, pinching, or twisting of the wrist. The force required to activate operable parts shall be 5.0 pounds (22.2 N) maximum.

**1002 Accessible Units**

**1002.9 Operable Parts.** Lighting controls, electrical switches and receptacle outlets, environmental controls, appliance controls, operating hardware for operable windows, plumbing fixture controls, and user controls for security or intercom systems shall comply with Section 309. (See 309.1, 309.2, 309.3, and 309.4.)

**ANSI A117.1 – 2009**

**1003 Type A Units**

**1003.9 Operable Parts.** Lighting controls, electrical switches and receptacle outlets, environmental controls, appliance controls, operating hardware for operable windows, plumbing fixture controls, and user controls for security or intercom systems shall comply with Section 309. (See 309.1, 309.2, 309.3, and 309.4.)

**ANSI A117.1 – 2009**

**1004 Type B Units**

**1004.9 Operable Parts.** Lighting controls, electrical switches and receptacle outlets, environmental controls, and user controls for security or intercom systems shall comply with Sections 309.2 and 309.3.

**Fair Housing Accessibility Guidelines**

**Section 100.205(c)(3)(ii)** requires that all covered multifamily dwellings with a building entrance on an accessible route shall be designed and constructed in such a manner that all premises within covered multifamily dwelling units contain light switches, electrical outlets, thermostats, and other environmental controls in accessible locations.

**Guideline** – Light switches, electrical outlets, thermostats, and other environmental controls would meet Section

100.205(c)(3)(ii) if operable parts of the controls are located no higher than 48 inches, and no lower than 15 inches, above the floor. If the reach is over an obstruction (for example, an overhanging shelf) between 20 and 25 inches in depth, the maximum height is reduced to 44 inches for forward approach; or 46 inches for side approach, provided the obstruction (for example, a kitchen base cabinet) is no more than 24 inches in depth. Obstructions should not extend more than 25 inches from the wall beneath a control.

**2012 MI Building Code** *(Nothing on Lighting Controls, Electrical Switches, and Outlets – Electrical Panel Box. Clear Floor Space.)*

**2015 MI Residential Code** *(Nothing on Lighting Controls, Electrical Switches, and Outlets – Electrical Panel Box. Clear Floor Space.)*

**1201.3 Door.** Any door or doorway directly opening into the electrical panel box location shall be 36" wide in accordance with Section 201.

**ANSI A117.1 – 2009**  
**1002 Accessible Units**

**1002.5 Doors and Doorways.** The primary entrance door to the unit, and all other doorways intended for user passage, shall comply with Section 404. (See 404.2.2.)

**ANSI A117.1 – 2009**  
**1003 Type A Units**

**1003.5 Doors and Doorways.** The primary entrance door to the unit, and all other doorways intended for user passage, shall comply with Section 404. (See 404.2.2.)

**ANSI A117.1 – 2009**  
**1004 Type B Units**

**1004.5 Doors and Doorways.** Doors and doorways shall comply with Section 1004.5. (See 1004.5.1, 1004.5.2, 1004.5.2.1, and 1004.5.2.2.)

**Fair Housing Accessibility Guidelines**

See Section 100.205(c)(2)(2)

**2012 MI Building Code** *(Nothing on Lighting Controls, Electrical Switches, and Outlets – Door to Electrical Panel Box space.)*

**2015 MI Residential Code**

**Section 311 Means of Egress**

**R311.2.1 Interior Doors.** Interior doors shall not be less than 24 inches (609 mm) in width and 6 feet, 6 Inches (1980 mm) in height.

**EXCEPTION:** Doors to areas less than 10 square feet of floor area.

**1201.4 Electrical Panel Box Upper Fuse Height.** The upper most circuit breaker switch is a maximum of 54" above the finished floor.

**ANSI A117.1 – 2009**

**309 Operable Parts**

**309.1 General.** Operable parts required to be accessible shall comply with Section 309.

**309.2 Clear Floor Space.** A clear floor space complying with Section 305 shall be provided.

**309.3 Height.** Operable parts shall be placed within one or more of the reach ranges specified in Section 308.

**309.4 Operation.** Operable parts shall be operable with one hand and shall not require tight grasping, pinching, or twisting of the wrist. The force required to activate operable parts shall be 5.0 pounds (22.2 N) maximum.

**ANSI A117.1 – 2009**

**1002 Accessible Units**

**1002.9 Operable Parts.** Lighting controls, electrical switches and receptacle outlets, environmental controls, appliance controls, operating hardware for operable windows, plumbing fixture controls, and user controls for security or intercom systems shall comply with Section 309. (See 309.1, 309.2, 309.3, and 309.4.)

**ANSI A117.1 – 2009**

**1003 Type A Units**

**1003.9 Operable Parts.** Lighting controls, electrical switches and receptacle outlets, environmental controls, appliance controls, operating hardware for operable windows, plumbing fixture controls, and user controls for security or intercom systems shall comply with Section 309. (See 309.1, 309.2, 309.3, and 309.4.)

**ANSI A117.1 – 2009**

**1004 Type B Units**

**1004.9 Operable Parts.** Lighting controls, electrical switches and receptacle outlets, environmental controls, and user controls for security or intercom systems shall comply with Sections 309.2 and 309.3.

**Fair Housing Accessibility Guidelines**

**Section 100.205(c)(3)(ii)** requires that all covered multifamily dwellings with a building entrance on an accessible route shall be designed and constructed in such a manner that all premises within covered multifamily dwelling units contain light switches, electrical outlets, thermostats, and other environmental controls in accessible locations.

**Guideline –** Light switches, electrical outlets, thermostats, and other environmental controls would meet Section 100.205(c)(3)(ii) if operable parts of the controls are located no higher than 48 inches, and no lower than 15 inches, above the floor. If the reach is over an obstruction (for example, an overhanging shelf) between 20 and 25 inches in depth, the maximum height is reduced to 44 inches for forward approach; or 46 inches for side approach, provided the obstruction (for example, a kitchen base cabinet) is no more than 24 inches in depth. Obstructions should not extend more than 25 inches from the wall beneath a control.

**2012 MI Building Code** (*Nothing on Lighting Controls, Electrical Switches, and Outlets – Upper Fuse Height to Electrical Panel*)

8/8/2016 10:04:11 AM

[www.zerostep.org](http://www.zerostep.org)

Box.)

**2015 MI Residential Code** (*Nothing on Lighting Controls, Electrical Switches, and Outlets – Upper Fuse Height to Electrical Panel Box.*)

**These requirements are derived from the most recent edition of The ANSI Reference Codes, The Fair Housing Guidelines, The Michigan Building Codes and The Michigan Residential Codes. As these codes are updated, so too will the ZeroStep™ Guidelines.**



## Chapter 13. Heating, Ventilation and Air Conditioning

The contents of this section define what a ZeroStep™ heating, ventilation and air conditioning configuration is. Following each ZeroStep™ guidelines section are provided references to the most recent edition of The ANSI Reference Codes, The Fair Housing Guidelines, The Michigan Building Codes, and The Michigan Residential Codes, from which the measures and dimensions requirements were derived and expanded upon.

### 1301 Heating, Ventilation and Air Conditioning (HVAC)

**1301.1 Thermostat.** The thermostat shall be on an accessible route, according to Section 101.

ANSI A117.1 – 2009

#### 309 Operable Parts

**309.1 General.** Operable parts required to be accessible shall comply with Section 309.

**309.2 Clear Floor Space.** A clear floor space complying with Section 305 shall be provided.

**309.3 Height.** Operable parts shall be placed within one or more of the reach ranges specified in Section 308.

**309.4 Operation.** Operable parts shall be operable with one hand and shall not require tight grasping, pinching, or twisting of the wrist. The force required to activate operable parts shall be 5.0 pounds (22.2 N) maximum.

ANSI A117.1 – 2009

#### 1002 Accessible Units

**1002.3 Accessible Route.** Accessible routes within Accessible units shall comply with Section 1002.3.

ANSI A117.1 – 2009

#### 1003 Type A Units

**1003.3 Accessible Route.** Accessible routes within Type A units shall comply with Section 1003.3.

ANSI A117.1 – 2009

#### 1004 Type B Units

**1004.3 Accessible Route.** Accessible routes within Type B units shall comply with Section 1004.3. (See 1004.3.1.)

## Fair Housing Accessibility Guidelines

See Section [100.205\(c\)\(3\)\(ii\)](#).

## 2012 MI Building Code (Nothing on Heating, Ventilation and Air Conditioning (HVAC) – Thermostat.)

### Section 1109 Other Features and Facilities

**1109.13 Controls, operating mechanisms and hardware.** Controls, operating mechanisms and hardware intended for operation by the occupant, including switches that control lighting and ventilation and electrical convenience outlets, in accessible spaces, along accessible routes or as part of accessible elements shall be accessible.

#### **EXCEPTIONS:**

1. Operable parts that are intended for use only by service or maintenance personnel shall not be required to be accessible. (Additional exceptions included in MBC)

## 2015 MI Residential Code (Nothing on Heating Ventilation and Air Conditioning (HVAC) - Thermostat, Accessible Routes.)

**1301.2 Thermostat Clear Floor Space.** A clear 32" x 48" minimum clear floor space shall be provided at the thermostat for either a parallel or perpendicular approach.

## ANSI A117.1 – 2009

### 309 Operable Parts

**309.1 General.** Operable parts required to be accessible shall comply with Section 309.

**309.2 Clear Floor Space.** A clear floor space complying with Section [305](#) shall be provided.

**309.3 Height.** Operable parts shall be placed within one or more of the reach ranges specified in Section 308.

**309.4 Operation.** Operable parts shall be operable with one hand and shall not require tight grasping, pinching, or twisting of the wrist. The force required to activate operable parts shall be 5.0 pounds (22.2 N) maximum.

## ANSI A117.1 – 2009

### 1002 Accessible Units

**1002.9 Operable Parts.** Lighting controls, electrical switches and receptacle outlets, environmental controls, appliance controls, operating hardware for operable windows, plumbing fixture controls, and user controls for security or intercom systems shall comply with Section 309. (See [309.2](#), [305.1](#), [305.2](#), [305.3](#), [305.4](#), [305.5](#), [305.6](#), [305.7](#), [305.7.1](#), and [305.7.2](#).)

## ANSI A117.1 – 2009

### 1003 Type A Units

**1003.9 Operable Parts.** Lighting controls, electrical switches and receptacle outlets, environmental controls, appliance controls, operating hardware for operable windows, plumbing fixture controls, and user controls for security or intercom systems shall comply with Section 309. (See [309.2](#), [305.1](#), [305.2](#), [305.3](#), [305.4](#), [305.5](#), [305.6](#), [305.7](#), [305.7.1](#), and



305.7.2.)

**ANSI A117.1 – 2009**

**1004 Type B Units**

**1004.9 Operable Parts.** Lighting controls, electrical switches and receptacle outlets, environmental controls, and user controls for security or intercom systems shall comply with Sections 309.2 and 309.3.

**Fair Housing Accessibility Guidelines**

See Section 100.205(c)(3)(ii).

**2012 MI Building Code** (*Nothing on Heating, Ventilation and Air Conditioning (HVAC) – Thermostat Clear Floor Space.*)

**Section 1109 Other Features and Facilities**

**1109.13 Controls, operating mechanisms and hardware.** Controls, operating mechanisms and hardware intended for operation by the occupant, including switches that control lighting and ventilation and electrical convenience outlets, in accessible spaces, along accessible routes or as part of accessible elements shall be accessible.

**EXCEPTIONS:**

1. Operable parts that are intended for use only by service or maintenance personnel shall not be required to be accessible. (Additional exceptions included in MBC)

**2015 MI Residential Code** (*Nothing on Heating, Ventilation and Air Conditioning (HVAC) – Thermostat Clear Floor Space.*)

**These requirements are derived from the most recent edition of The ANSI Reference Codes, The Fair Housing Guidelines, The Michigan Building Codes and The Michigan Residential Codes. As these codes are updated, so too will the ZeroStep™ Guidelines.**

# ZeroStep Glossary



## A

### Accessible

Easy to approach, reach, enter, speak with or use.

<http://dictionary.reference.com/browse/accessible>

### Accessible bathtub

An accessible bathtub is a bathtub that can be usable by anyone regardless of physical ability. It could be a walk-in style tub with a door or a standard tub with a lift installed. [www.zerostep.org](http://www.zerostep.org)

### Accessible closet

An accessible closet can be fully usable by people of varying size and abilities. An accessible closet is on an accessible route, has a closet door with a clear opening of 34" and a minimum 48" x 48" approach in front of a wall closet. The door swing may overlap the approach.

[www.zerostep.org](http://www.zerostep.org)

### Accessible design

Accessible Design complies with regulations or criteria that establish a minimum level of design necessary to accommodate a person with a disability. It applies most directly to commercial and governmental buildings under the ADA and the International Construction Code. This level of design applies to individual housing units which are required to be built as Type A units under the International Construction Code and the Uniform Federal Accessibility Standard (both of which use ICC/ANSI 117.1 as a reference standard.) [www.zerostep.org](http://www.zerostep.org)

### Accessible entrances

A means or point in which to enter or exit that can be approached and entered without any hindrance of any kind. [www.thefreedictionary.com/Accessible](http://www.thefreedictionary.com/Accessible)

### Accessible full bathroom

Is a bathroom that is on an accessible route? It is comprised of a 34" minimum clear width door opening; sink, toilet and bathtub or shower; a 5' diameter turning space; and 48" x 48" clear floor space at the sink, bathtub and shower. The toilet has a 48" x 66" approach. Walls are reinforced around the toilet, bathtub and shower for future grab bars. An accessible full bathroom can be used by people of all sizes and abilities. [www.zerostep.org](http://www.zerostep.org)

### Accessible half bath

Is a bathroom that is on an accessible route? It is comprised of a 34" minimum clear width door opening; a sink and toilet; a 5' diameter turning space; a 48" x 48" clear floor space at the sink and a

48" x 66" approach at the toilet. Walls are reinforced around the toilet for future grab bars. An accessible half bathroom can be used by people of all sizes and abilities [www.zerostep.org](http://www.zerostep.org)

### Accessible kitchen

Is a kitchen that is on an accessible route? It is comprised of a 34" minimum clear width door opening; a 5' diameter turning space; 48" x 48" clear floor space at the sink and each appliance. It can adapt to an open knee space under the sink if needed. Many amenities include different height work surface for either sitting or standing, pull-out drawers, swing-down shelves, under counter lighting, even adjustable height sink. An accessible kitchen can be used by people of all sizes and abilities. [www.zerostep.org](http://www.zerostep.org)

### Accessible laundry room

Is a laundry room or area that is on an accessible route with 48" x 48" clear floor space at the sink and each appliance. The appliances should be easy to use such as a front loading washer and dryer on pedestals, roll-under sink, good lighting, and a 5' diameter turning space with a 34" minimum clear door opening if in a room. [www.zerostep.org](http://www.zerostep.org)

### Accessible route

An accessible route is a continuous unobstructed path connecting all accessible elements and spaces of a house. Interior accessible routes may include corridors, floors, ramps, elevators, lifts, and clear floor space at fixtures. Exterior accessible routes may include parking access aisles, curb ramps, crosswalks at vehicular ways, walks, ramps, and lifts. [www.access-board.gov/adaag/html/adaag.htm](http://www.access-board.gov/adaag/html/adaag.htm)

### Accessible walk-in pantry

Is a pantry room or area that is on an accessible route with 48" x 48" clear floor space at the shelves. An accessible walk-in pantry should have adjustable shelving or pull-out shelving, good lighting, and a 34" minimum clear width door opening if in a room. [www.zerostep.org](http://www.zerostep.org)

### Accessibility

Capable of being reached and used by as many people as possible regardless of age or physical ability.

[www.zerostep.org](http://www.zerostep.org)

### Adaptability

The ability of certain building spaces and elements, such as kitchen counters, sinks, and grab bars, to be added or altered so as to accommodate the needs of all individuals with or without disabilities or to accommodate the needs of persons with different types or degrees of disability. [www.access-board.gov/adaag/html/adaag.htm](http://www.access-board.gov/adaag/html/adaag.htm)

### Adaptable design

An *adaptable* dwelling unit has all the accessible features that a fixed accessible unit has but allows some items to be omitted or concealed until needed so the dwelling units can look the same as others and be better matched to individual needs when occupied. In an adaptable dwelling, wide doors, no steps, knee spaces, control and switch locations, grab bar reinforcing and other access features must be built in. Grab bars however, can be omitted and installed when needed. Because the necessary blocking is already provided, the bars can simply be screwed in place without opening the existing walls to install reinforcing. Knee spaces can be concealed by installing a removable base cabinet that can simply be unscrewed from adjacent

cabinets and slipped out when needed or by installing self-storing cabinet doors that fold and slide back. Counter tops and closet rods can be placed on adjustable supports rather than fixed at lower heights as required for some wheelchair users. Standards for adaptable design have been incorporated into both ANSI and UFAS. These standards specify adaptability criteria, which will provide a level of full accessibility when adjustments are made.  
[www.design.ncsu.edu/cud/pubs\\_p/docs/Fact%20Sheet%206.pdf](http://www.design.ncsu.edu/cud/pubs_p/docs/Fact%20Sheet%206.pdf)

## Adjustable

A product that is capable of adapting or conforming, as to new conditions or as new needs arise, such as an adjustable height sink or adjustable shelving. [www.zerostep.org](http://www.zerostep.org)

## Americans with Disabilities Act (ADA)

The Americans with Disabilities Act (ADA) of 1990 is a civil rights law that protects qualified individuals with disabilities from discrimination and provides for equal access and opportunity. Former President George Bush signed the ADA into law on July 26, 1990.  
[www.adacourse.org/solutions.php?idarea=Design](http://www.adacourse.org/solutions.php?idarea=Design)

### **The ADA applies to situations in these five areas:**

1. Employment,
2. State and local government,
3. Public accommodations (private businesses),
4. Telecommunications, and
5. Transportation.

## American National Standards Institute (ANSI)

The Institute oversees the creation, promulgation and use of thousands of norms and guidelines that directly impact businesses in nearly every sector: from acoustical devices to construction equipment, from dairy and livestock production to energy distribution, and many more. ANSI is also actively engaged in accrediting programs that assess conformance to standards—including globally-recognized cross-sector programs such as the ISO 9000 (quality) and ISO 14000 (environmental) management systems.  
[www.ansi.org/about\\_ansi/overview/overview.aspx?menuid=1](http://www.ansi.org/about_ansi/overview/overview.aspx?menuid=1)

## Approach

Is the clear floor or ground space in front of something, such as the space in front of a ramp or a bathroom or kitchen fixture that only a door swing can encroach upon the space?  
[www.zerostep.org](http://www.zerostep.org)

## Architectural Barriers Act (ABA)

The ABA requires access to facilities designed, built, altered, or leased with federal funds. Passed by Congress in 1968, it marks one of the first efforts to ensure access to the built environment. The Access Board develops and maintains accessibility guidelines under this law. These guidelines serve as the basis for the standards used to enforce the law, the Uniform Federal Accessibility Standards (UFAS). Four Federal agencies are responsible for the standards: the Department of Defense, the Department of Housing and Urban Development, the General Services Administration, and the U.S. Postal Service. [www.access-board.gov/about/laws/ABA.htm](http://www.access-board.gov/about/laws/ABA.htm)

## B

### Baluster

Any of a number of closely spaced supports for a railing.  
<http://dictionary.reference.com/browse/balusters>

### Barrier-free design

Design that eliminates the obstacles in a space or product, making it fully usable by people of varying size and abilities. (Peterson, Mary Jo, [Building For A Lifetime: The Design and Construction of Fully Accessible Homes](#), The Taunton Press, Inc. 1994, pg. 4)

### Bi-fold doors

Bi-fold doors are doors designed to be used in closets, pantries, and in some cases as folding doors between rooms. Bi-fold doors are always done in pairs, with two doors folding to one side, or with four doors, split in the center of the opening, with two doors folding back to each side.  
[www.interiordoors.com/bifold.html](http://www.interiordoors.com/bifold.html)

### Blocking

Blocking is the use of 2x wood blocks behind a wall surface to provide sufficient reinforcement for grab bar installation. The blocking must be able to withstand 250 pounds of downward force. *All new construction should have blocking around the bathtub, shower and toilet, in order to avoid costly home renovation if grab bars are required in the future.* [www.zerostep.org](http://www.zerostep.org)

## C

### Casement window

A window frame hinged on one side so that it swings out or in to open.  
<http://ah.bfn.org/a/DCTNRY/c/casement.html>

### Centers for Independent Living (CIL)

Centers for Independent Living (CIL's) are typically non-residential, private, non-profit, consumer-controlled, community-based organizations providing services and advocacy by and for persons with all types of disabilities. [www.michigan.gov/mcsc/0,1607,7-137-8074\\_22503-62985--,00.html](http://www.michigan.gov/mcsc/0,1607,7-137-8074_22503-62985--,00.html); see also [www.dakc.us](http://www.dakc.us)

### Center for Universal Design

The Center for Universal Design (CUD) is a national information, technical assistance, and research center (located at North Carolina State University) that evaluates, develops, and promotes accessible and universal design in housing, commercial and public facilities, outdoor environments, and products. Its mission is to improve environments and products through design innovation, research, education and design assistance. [www.design.ncsu.edu/cud/](http://www.design.ncsu.edu/cud/)

## Central vacuum

In a central vacuum system a central power unit sits in an out-of-the-way area such as your garage, basement or utility room. Wall inlet valves are then installed in various locations throughout the home and connected to the power unit through tubing. After installation, the system can be activated by simply plugging the lightweight hose into a wall inlet. The system then carries the dirt, dust, animal dander and allergens out of the room into the main power unit and deposits all of the debris into the canister. [www.mdbfaa.org/html/central\\_vacuum.asp](http://www.mdbfaa.org/html/central_vacuum.asp)

## Change in level

A change in level occurs when the threshold height between two areas of different surface types is not flush. [www.zerostep.org](http://www.zerostep.org)

## Clearance

The amount of space or distance by which a moving object clears something. The height or width of a passage. [www.thefreedictionary.com/clearance](http://www.thefreedictionary.com/clearance)

## Clear width

Clear width is measured from the face of the door to the stop when the door is "fully opened" at 90 degrees. [www.highbeam.com/doc/1G1-12087314.html](http://www.highbeam.com/doc/1G1-12087314.html)

## Clear floor space

Is a 48" x 48" minimum approach to something, such as a bathroom or kitchen fixture, in which there is space to maneuver. [www.zerostep.org](http://www.zerostep.org)

## Clothing carousel

A clothing carousel is a garment delivery system. The unit is installed in a closet. Clothes are hung along a carousel or conveyor line. By pressing a button, the clothes rotate along a circular track, allowing a person to browse their wardrobe and retrieve the garment he or she wants. [www.zerostep.org](http://www.zerostep.org)

## Comfort height toilet

A comfort height toilet is a tall toilet that has a rim height of at least 16". The recommended height by most experts is 18". [www.zerostep.org](http://www.zerostep.org)

## Cross slope

The slope that is perpendicular to the direction of travel. [www.access-board.gov/adaag/html](http://www.access-board.gov/adaag/html)

# D

## Deadbolt

A bolt on a lock that is moved by turning the key or knob without activation of a spring. <http://dictionary.reference.com/browse/Deadbolt>

## Dimmer switch

A rheostat or similar device by which the intensity of an electric light may be varied. <http://dictionary.reference.com/browse/Dimmer%20switch>

## Double hung window

A window, which has two sashes that slide up and down.  
[www.bartleby.com/61/57/D0355700.html](http://www.bartleby.com/61/57/D0355700.html)

## D-shaped hardware

Hardware that is D shaped can be used without tight grasping, pinching or twisting.  
[www.zerostep.org](http://www.zerostep.org)

# E

## Edge protection

A raised edge on the side of a path of travel, such as a ramp, to prevent people from rolling off.  
[www.zerostep.org](http://www.zerostep.org)

## Emergency egress

At least one window in each bedroom must be of sufficient size to permit the occupants to escape a fire and also to allow a fully outfitted firefighter to enter.  
[www.taunton.com/finehomebuilding/how-to/articles/code-violations-emergency-egress-windows.aspx](http://www.taunton.com/finehomebuilding/how-to/articles/code-violations-emergency-egress-windows.aspx)

### **An egress window must satisfy all four International Residential Code (IRC) criteria:**

- Minimum width of opening: 20 in.
- Minimum height of opening: 24 in.
- Minimum net clear opening: 5.7 sq. ft. (5.0 sq. ft. for ground floor).
- Maximum sill height above floor: 44 in.

## Environmental control unit

An electronic device that allows you to control dozens of products in your home by touch screen, voice commands, head movements, or switch scanning with the movement of nearly any body part.  
[www.spinalcord.uab.edu/show.asp?durki=21729](http://www.spinalcord.uab.edu/show.asp?durki=21729)

# F

## Fair Housing Guidelines

The purpose of the Fair Housing Accessibility Guidelines is to provide technical guidance on designing dwelling units as required by the Fair Housing Amendments Act of 1988. These Guidelines are not mandatory, but are intended to provide a safe harbor for compliance with the accessibility requirements of the Fair Housing Act.  
[www.fairhousingadvocates.com/accessibility.pdf](http://www.fairhousingadvocates.com/accessibility.pdf)

## Folding Door

A door with hinged leaves or accordion pleats that can be folded back.  
[www.yourdictionary.com/folding-door](http://www.yourdictionary.com/folding-door)

# G

## Galley or Pullman Kitchen

A galley or Pullman kitchen is when a kitchen is long and narrow and has a door or doorway opening at one or both ends. [www.zerostep.org](http://www.zerostep.org)

## Grab bars

Grab bars are used around toilets, bathtubs, and showers to provide grasping and support surfaces. They help people maintain balance while transferring from a wheelchair or while sitting down from a standing position. People also rest their arms on grab bars to reach controls or to maintain balance, especially when they have limited grasping ability.  
[www.design.ncsu.edu/cud/pubs\\_p/phousing.htm](http://www.design.ncsu.edu/cud/pubs_p/phousing.htm) (Bathrooms)

# H

## Handheld shower

A handheld shower is a showerhead that attaches to a conventional bathtub faucet or an existing showerhead or rail. It is held in one's hand instead of being mounted in a fixed location like a standard showerhead. The hose should be at least 6' longer or longer, in order to reach all parts of the shower. A handheld shower is versatile and convenient for families of varying heights, for caregivers and for the ability to shower while seated. The water can be directed exactly where it is needed, like a sore muscle or even the family pet. [www.zerostep.org](http://www.zerostep.org)

## Handrail

A horizontal or sloping rail intended for grasping by the hand for guidance or support.  
[International Building Code: International Code Council, Inc.: 2006](#)

## Hardwired

Implemented in the form of permanent electronic circuits; also: connected or incorporated by or as if by permanent electrical connections. [www.m-w.com/cgi-bin/dictionary?book=Dictionary&va=hardwired](http://www.m-w.com/cgi-bin/dictionary?book=Dictionary&va=hardwired)

## Hearing loop system

Loop systems are a class of Hearing Assistive Technology (HAT)/Assistive Listening Devices (ALDs) that work together with hearing aids to help hard of hearing people hear better. Other classes of ALDs include such things as Personal Amplifiers (PockeTalker), FM systems and infrared systems. Unlike the above systems, you do not have to wear anything extra in order to connect to, and use, a loop system—no neckloops, wires, silhouettes, receivers or headphones.



All you need are your hearing aids equipped with telecoils.  
[www.hearinglosshelp.com/articles/loopsystems.htm](http://www.hearinglosshelp.com/articles/loopsystems.htm)

## Home air purifier

Air purifiers utilize a variety of technologies to destroy microorganisms, chemicals, odors, and other contaminants, often at the molecular level. There are many methods for cleaning air. Special filters are available that provide for a very high level of air purity.  
[www.cleanair4life.com/AirPurifiersAndCleaners.htm](http://www.cleanair4life.com/AirPurifiersAndCleaners.htm)

## Home network system

A home network system is a convenient, time-saving application and service that allows diverse and unrelated products in the home environment to operate as a system. It could include a security system, a garage-door opener that knows when to go up, or a front porch light that knows when to go on, ceiling fan, television, media center, and master bedroom alarm clock radio that can freely pass information back and forth amongst themselves. [www.zerostep.org](http://www.zerostep.org)

## Hearing Loop System

An infrared, FM, and induction loop systems all enable people with hearing loss to hear clearer TV sound—and, to their family members' relief, with their own individually adjusted volume. By broadcasting through one's own customized hearing aids, loop systems work especially well.  
[www.hearingloop.org/places\\_hometv.htm](http://www.hearingloop.org/places_hometv.htm)

## Heating, Ventilation and Air Conditioning (HVAC)

Heating, Ventilation and Air Conditioning (HVAC) is a system that provides for human environmental comfort within a building. HVAC systems control air temperature and humidity level, clean the air and provide fresh air. Equipment can include furnaces, boilers, electric heaters, air conditioners, humidifiers, and fans. [www.zerostep.org](http://www.zerostep.org)



## Inclusive Home Design Act for State of Michigan

As of January 1, 2007, at least 50% of family, two family, and three family newly constructed dwellings using funds provided as construction loans from Michigan State Housing Development Authority (MSHDA) shall be constructed according to the Type B (adaptable) dwelling unit requirements of the Michigan Construction Code. [Press release to the Grand Rapids Press from Disability Advocates of Kent Co., Grand Rapids, MI, July 17, 2006.](#)

## Intercoms

Internal communication system: a system or device that allows people in different parts of a building to speak to each other.

<http://encarta.msn.com/encnet/features/dictionary/DictionaryResults.aspx?refid=1861621757>

# K

## Keyless entry

A keyless entry is a means for locking or unlocking a door from a remote location through the use of a hand held or wall mounted control unit. The control unit can operate a gate, house door or garage door when a 3 or 4 digit electronic code is entered. [www.zerostep.org](http://www.zerostep.org)

## Knee space

Knee space is an open space under a counter surface. Knee spaces make it possible to be close to counter work areas, sinks, and cook tops while sitting. They should be at least 36" wide, 27" high, and 19" deep. [www.zerostep.org](http://www.zerostep.org)

# L

## Landing

Landings are the level areas required at the top, bottom, and sometimes at intermediate locations in a ramp way. These areas allow a person to maintain balance while performing tasks like opening doors, transferring in and out of a vehicle, resting for a time, and safely changing direction of travel when a ramp makes a turn. Recommended landing sizes are based on these functions.

[www.wheelchairramp.org/rampman/manual/ramp08.htm](http://www.wheelchairramp.org/rampman/manual/ramp08.htm)

## Level

Having no part higher than another; having a flat or even surface.

<http://dictionary.reference.com/browse/Level>

## Lever handles

Lever handles are straight, bar-like handle hardware for door and water faucets. Unlike a knob, they require little strength or twisting and they are easy to operate with a fist, arm or knee movement if one's hands are full. [www.zerostep.org](http://www.zerostep.org)

## L-shaped kitchen

An L-shaped kitchen is space planned or configured like an "L". It provides a lot of work and storage space along two walls. The walking distance between the main work areas of the kitchen (sink, oven and refrigerator) are minimized. There is usually enough space for a kitchen table or an island.

[www.zerostep.org](http://www.zerostep.org)

## M–N

### Maneuvering clearance

A maneuvering clearance is the amount of clear floor space on both sides of the latch side of the door.

[www.zerostep.org](http://www.zerostep.org)

### Motion activated faucet

A motion-activated faucet has an electronic sensor that operates automatically when placing your hands under the spout. This hands-free operation makes it easy to rinse off hands in a flash and is perfect for sinks used by children, seniors, or anyone who may have difficulty operating faucet controls. Some models are temperature controlled or others have interchangeable color temperature control handles that are easy-to-use by adjusting the temperature and placing your hands under the spout which activates the water flow.

[www.faucet.com/decor/static.pl?S=basics/help\\_plumbing\\_glossary#H](http://www.faucet.com/decor/static.pl?S=basics/help_plumbing_glossary#H)

### Motion activated lighting

Motion activated lighting are light fixtures with motion sensors. Motion activated lighting detects people, animals and cars, and turns lights on automatically. They provide convenience, security and energy savings. [www.zerostep.org](http://www.zerostep.org)

## O

### Offset door hinges

Swing clear offset door hinges widen doorways for easier walker and wheelchair access, swinging the door completely clear of the opening. [www.adaptiveaccess.com/offset\\_hinges.php](http://www.adaptiveaccess.com/offset_hinges.php)

### Open risers

Staircases which consist only of treads are said to have “open risers.” Under the 1996 COBE model code, open risers are no longer permitted because they are a danger to children. They are also a danger to the elderly, who tend to catch their toe on the tread and trip.

[www.sizes.com/home/stairs.htm](http://www.sizes.com/home/stairs.htm)

### Optimal reach zone

The optimal reach zone is the comfortable distance for a person’s reach. It varies according to (1) whether a person is standing or seated, (2) whether they are reaching forward (a perpendicular approach) or are reaching from their side (a parallel approach), and (3) whether they are reaching over something, e.g. a counter. For seated people, forward range is approximately 15" to 48" above the floor. For standing people, a reach range can be 2' to 6' above the floor. [www.zerostep.org](http://www.zerostep.org)

## P–Q

### Parallel approach

A parallel approach is where a person using a wheelchair approaches an object or fixture by positioning themselves parallel to the object or fixture for a side reach. An example is when the user is in a seated position alongside (parallel) to a cabinet for a side reach over the cabinet. Generally, a parallel approach allows the person to get closer to the object they are trying to reach than a perpendicular approach.

[www.zerostep.org](http://www.zerostep.org)

### Perpendicular approach

A perpendicular approach is where a person using a wheelchair approaches an object or fixture by positioning themselves perpendicular to the object or fixture for a forward reach. An example is when the user is in a seated position perpendicular to a counter for a forward reach over the cabinet. A perpendicular approach is also known as a forward approach. It is more difficult for the person to get close to the object if there is no 36" wide clear knee space as deep as the reach distance.

[www.zerostep.org](http://www.zerostep.org)

### Platform lift

Platform lifts are designed to lift a person to another level of their environment while still seated in their wheelchair. Platform lifts can be operated by the person in the wheelchair and/or remotely by an attendant. There are two types of platform lifts: vertical platform lifts that operate like small elevators, and inclined platform lifts that are installed in a stairway. [www.adaptive-environments.com](http://www.adaptive-environments.com)

### Pocket doors

Pocket doors slide into a wall and are hidden when fully opened. [Home Modifications for Remodelers and Designers: School of Design](#), The Center for Universal Design; North Carolina State University, June 2000.

## R

### Ramp curb

A ramp curb is the edge that is built up with either wood or concrete to prevent someone from falling off. It is edge protection. [www.zerostep.org](http://www.zerostep.org)

### Ramp run

A ramp run is the sloped, horizontal projection or dimension between level landings. [www.zerostep.org](http://www.zerostep.org)

## Remote controls

A remote control is an electronic device used for the remote operation of a machine.

[http://en.wikipedia.org/wiki/Remote\\_controls](http://en.wikipedia.org/wiki/Remote_controls)

## Rocker switch

A rocker switch is an on/off switch that rocks (rather than trips) when pressed, which means one side of the switch is raised while the other side is depressed much like a rocking horse rocks back and forth.

[http://whatis.techtarget.com/definition/0..sid9\\_gci770432.00.html](http://whatis.techtarget.com/definition/0..sid9_gci770432.00.html)

## Roll-under sink, stovetop or counter

Provide barrier free access for a person using a wheelchair by fitting one's knees underneath the sink, stovetop or counter. Cover or insulate the pipes to prevent leg burns.

[www.zerostep.org](http://www.zerostep.org)

# S

## Scald guard

A scald guard is a device used to prevent the water from the bathtub or sink from becoming too hot.

[www.wisegeek.com/what-is-scald-guard.htm](http://www.wisegeek.com/what-is-scald-guard.htm)

## Security systems

A device or multiple devices designed, installed and operated to monitor, detect, observe or communicate about activity that may pose a security threat in a location.

[www.sunocoinc.com/Site/HES/Glossary/STerms.htm](http://www.sunocoinc.com/Site/HES/Glossary/STerms.htm)

## Sensor lights

Occupancy sensors—indoor lighting controls—detect activity within a certain area. They provide convenience by turning lights on automatically when someone enters a room. They reduce lighting energy use by turning lights off soon after the last occupant has left the room.

[www.eere.energy.gov/consumer/your\\_home/lighting\\_daylighting/index.cfm/mytopic=12210](http://www.eere.energy.gov/consumer/your_home/lighting_daylighting/index.cfm/mytopic=12210)

## Shut-off valves

Shut-off valves permit turning off the water supply to individual fixtures like sinks, tubs and toilets without having to shut off the main water supply or large sections of household plumbing.

<http://query.nytimes.com/gst/fullpage.html?res=950DE3D7153FF930A35751C1A96F948260>

## Sidelite

A sidelite is either a narrow, inoperable door with glazed panels, or it is a fixed window connected to one or both sides of an entry door's frame. ... Though sidelites sometimes feature solid panels, they are often fully-glazed in order to maximize the amount of natural light admitted to an entry hall. Some sidelites are even hinged so that they can enlarge the size of the door opening, making it easier to move large pieces of furniture into and out of the house.

[www.ebuild.com/articles/articleId.400786/doors.hwx](http://www.ebuild.com/articles/articleId.400786/doors.hwx)

## Stile

The stile is basically the frame of the cabinet behind the door. Your cabinet is faced with rails and styles and then the door is attached to the stiles. If it runs vertical, it's called a stile. If it runs horizontally, it's called a rail. [http://wiki.answers.com/Q/What is a cabinet stile&src=ansTT](http://wiki.answers.com/Q/What_is_a_cabinet_stile&src=ansTT)

## Sliding doors

A door that opens by sliding instead of swinging. <http://wordnet.princeton.edu/perl/webwn>

## Slope

The relative steepness of the land between two points. [Fair Housing Act Design Manual](#), U.S. Department of Housing and Urban Development; August 1996; Revised April 1998

## Split-level entry

A split-level entry is where a person enters the home on what is typically a small landing and can either travel up a few steps to enter the main living quarters of the home, or can descend a full flight of stairs to the basement or lower level of the home. [www.zerostep.org](http://www.zerostep.org)

## Stair lifts

A stair lift is a mechanical device for lifting people and wheelchairs up and down stairs. For sufficiently wide stairs, a rail is mounted to the treads of the stairs. A chair or lifting platform is attached to the rail. A person on the chair or platform is lifted as the chair or platform moves along the rail.

[www.answers.com/topic/stairlift-1?cat=technology](http://www.answers.com/topic/stairlift-1?cat=technology)

## Stair riser

The vertical boards that close the space between each stair tread on a set of stairs.

[www.cdc.gov/nceh/publications/books/housing/cha06.htm](http://www.cdc.gov/nceh/publications/books/housing/cha06.htm)

## Stair tread

The horizontal board in a stairway that is walked upon.

[www.cdc.gov/nceh/publications/books/housing/cha06.htm](http://www.cdc.gov/nceh/publications/books/housing/cha06.htm)

## Stile

A stile is the vertical outside member and the vertical center member in the framework of cabinets. The center stile has no function other than to hide spacing variations between cabinet doors, and may be removed if unrestricted cabinet width is required. [www.zerostep.org](http://www.zerostep.org)

# T

## Three-way switch

Three-way switches control lights and receptacles from two points: for example, a light in a hallway that can be operated from the first floor and second floor; or, a light in a garage that can be turned on/off from the garage and the kitchen or pantry, etc.

[www.the-home-improvement-web.com/information/how-to/three-way-switch.htm](http://www.the-home-improvement-web.com/information/how-to/three-way-switch.htm)

## Threshold

The sill of a doorway. <http://dictionary.reference.com/browse/Threshold>

## Toe kick space

The toe kick space is the space between the floor and the bottom shelf of a base cabinet. It is a recessed space for one's feet and is important for getting closer to the counter. Standard American cabinets have a 3 ½" to 4" high by 2" to 2 ¼" deep toe kick space. European cabinets have a higher and deeper toe kick space, such as 8 high by 3 ½" deep. [www.zerostep.org](http://www.zerostep.org)

## Turning space or Turning diameter

The space required for a person using a wheelchair to make a 180-degree turn is a circle with a diameter of 60 inches. [Fair Housing Act Design Manual, U.S. Department of Housing and Urban Development](#); August 1996; Revised April 1998

# U

## U-shaped kitchen

A U-shaped kitchen is a kitchen with cabinets and appliances along three adjoining walls. It provides the maximum continuous counter space and has less traffic interference than other kitchen layouts.

[www.zerostep.org](http://www.zerostep.org)

## U-shaped hardware

U-shaped hardware relates to the shape of the hardware used to open cabinet doors and cupboards. This hardware is easy to use because it does not require a tight grasp.

[www.zerostep.org](http://www.zerostep.org)

## Universal design

Universal design is the design of products and environments to be usable by all people, to the greatest extent possible, without the need for adaptation or specialized design. [Universal Design: Housing for the Lifespan of all People](#); Ron Mace, U.S. Dept. of Housing and Urban Development, 1998

# V-Z

## Voice control system

A voice control system allows a person to control all the systems of their home including, lights, devices, appliances, home theatre—audio/video, security, climate, telephone and the Internet from any location either within or outside of the home by voice. [www.zerostep.org](http://www.zerostep.org)

## Wall reinforcement

According to ZeroStep® Guidelines®, reinforcement is required in bathroom walls so that future grab bars may be easily installed. The best reinforcement consists of 2" blocking between the stud walls around toilets, bathtubs and showers. [www.zerostep.org](http://www.zerostep.org)

## Wet room

A wet room is created by making the space adjoining the shower waterproof as well, sloping the entire floor towards the shower. [Universal Kitchen and Bathroom Planning](#); National Kitchen and Bath Association; Mary Jo Peterson; Mc-Graw-Hill, 1998

## Wireless Internet

The term wireless is normally used to refer to any type of electrical or electronic operation which is accomplished without the use of a "hard wired" connection. Wireless communication is the transfer of *information* over a distance without the use of electrical conductors or "wires".

<http://en.wikipedia.org/wiki/Wireless>

## Zero-step entrance

One or more step-less entrances with a flush threshold.